

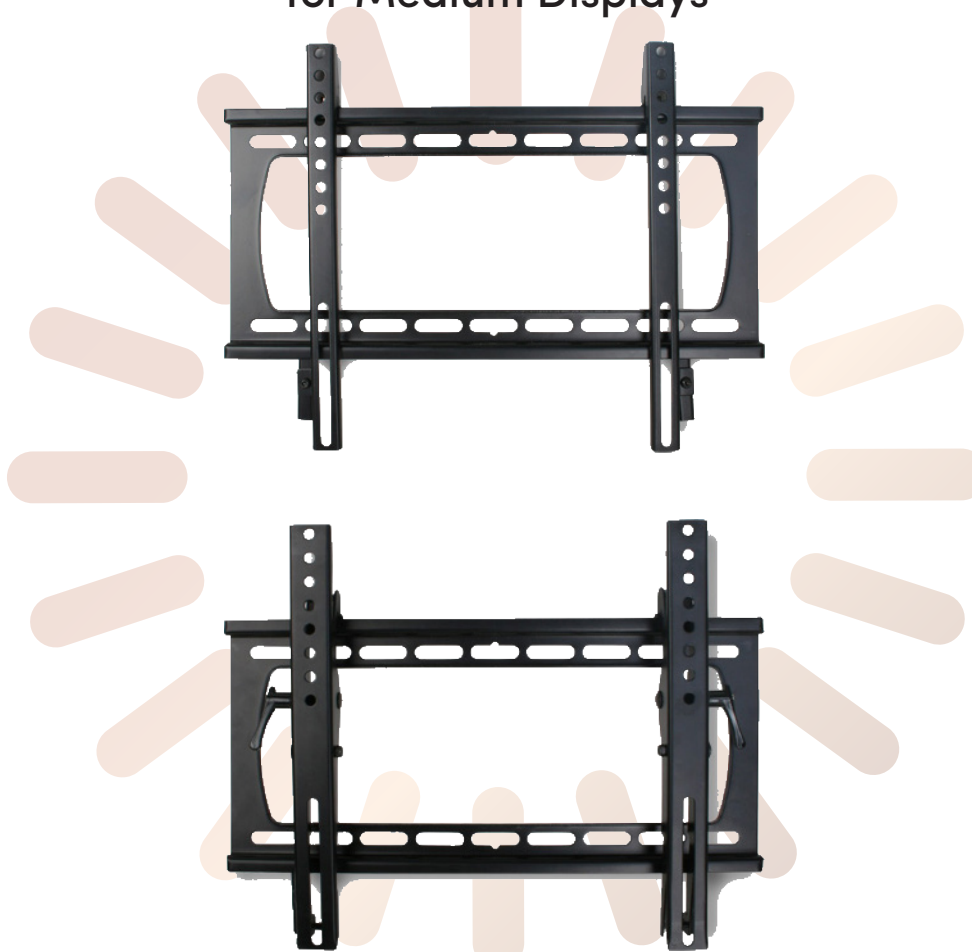

SUNBRITE

SB-WM-F-M-BL / SB-WM-T-M-BL

Weatherproof Universal Fixed and Tilt Mounts for Medium Displays



Install Guide

Warnings

Installation by a qualified professional is highly recommended for this product.

Do not begin installation until you have thoroughly read and understand these instructions.

This mount supports displays up to VESA 400×300, and a maximum load of 100 lbs (45.5 kg).

Ensure the wall can safely support four times the combined weight of the mount and display.

The manufacturer does not accept responsibility for incorrect installation.

Specifications

Maximum Load: 100 lbs (45.5 kg)

Forward Tilt Range: -8° / +13°

Horizontal Tilt Range: +5°

Dacromet Coated Assembly

Stainless Steel Mounting Hardware

Box Contents

Wall Plate (1)

Left Arm (1)

Right Arm (1)

Hex Wrench (1)

Security Wrench (1)

Hardware Kit

Tools Required

Power Drill

1/4" & 5/16" Drill Bits























Level

1/2" (13mm) Wrench

Stud Finder

Phillips Screwdriver

Hardware Kit

| | | | | |
|-------|---|---|---|---|
| Bag 1 |  (A) M4×10 bolt × 4 |  (B) M4×20 bolt × 4 |  (C) M4×30 bolt × 4 |  (D) M4×40 bolt × 4 |
| Bag 2 |  (E) M5×10 bolt × 4 |  (F) M5×20 bolt × 4 |  (G) M5×30 bolt × 4 |  (H) M5×40 bolt × 4 |
| Bag 3 |  (I) M6×10 bolt × 4 |  (J) M6×20 bolt × 4 |  (K) M6×30 bolt × 4 |  (L) M6×40 bolt × 4 |
| Bag 4 |  (M) M8×10 bolt × 4 |  (N) M8×20 bolt × 4 |  (O) M8×30 bolt × 4 |  (P) M8×40 bolt × 4 |
| Bag 5 |  (Q) M4/M5 spacer × 8 |  (R) M6/M8 spacer × 8 |  (S) M5 washer × 16 |  (T) M8 Washer × 8 |
| Bag 6 |  (U) M8×63 Lag Bolt (x6) | |  (V) Washer (x6) | |
| Bag 7 |  (W) Concrete anchor (x6) | | | |

Installation

Caution: Overtightening bolts can damage the bolts and reduce their holding strength.

Mount the Wall Bracket

Pro Tip: The wall bracket features a screw slot for temporary placement to help mark pilot holes.

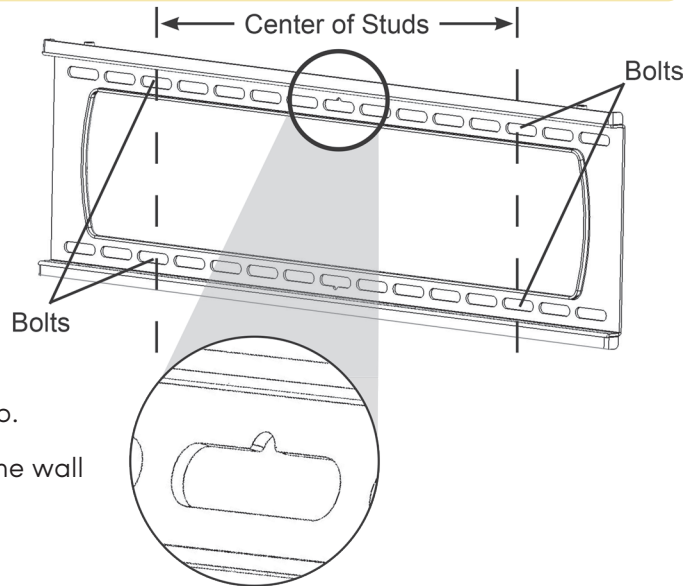

For Mounting on a Stud Wall

Use a stud finder to locate your studs. Drill pilot holes into two wood studs using a 1/4" drill bit. Drill into the center of the studs at least 2-1/2" deep.

Insert four lag bolts (U) and washers (V) through the wall plate into the pilot holes and tighten.

For Mounting on a Concrete Wall

Drill anchor holes into concrete using 5/16" drill bits to a depth of 2-1/2". Insert concrete wall anchors (W) and tap in with a hammer. Ensure the anchors are embedded entirely within the concrete.

Insert four lag bolts (U) into the wall anchors through the wall plate. Tighten all bolts.

Caution: Concrete must be 2000 psi density minimum. Lighter density concrete may not hold concrete anchor. Cinder block must meet ASTM C-90 specifications.

Caution: Before drilling, verify the concrete is at least 1-3/8" thick. Mount in a solid part of the block, generally 1" minimum from the side of the block. Do not drill into mortar joints. Use a standard electric drill on slow setting. Do not use a hammer drill to avoid damage.

Mount Arms to TV

Determine the screw size that fits your TV by carefully hand-threading them (A-P) into the threaded insert on the rear of the TV. If there is any resistance, stop immediately.

Thread the screw through the washer (S or T), arm, spacer (Q or R, if needed), and into the TV. Spacers are commonly needed on TVs with curved backs or recessed screw inserts.

Ensure the arms are installed flat side to TV and square to each other after all screws have been installed.

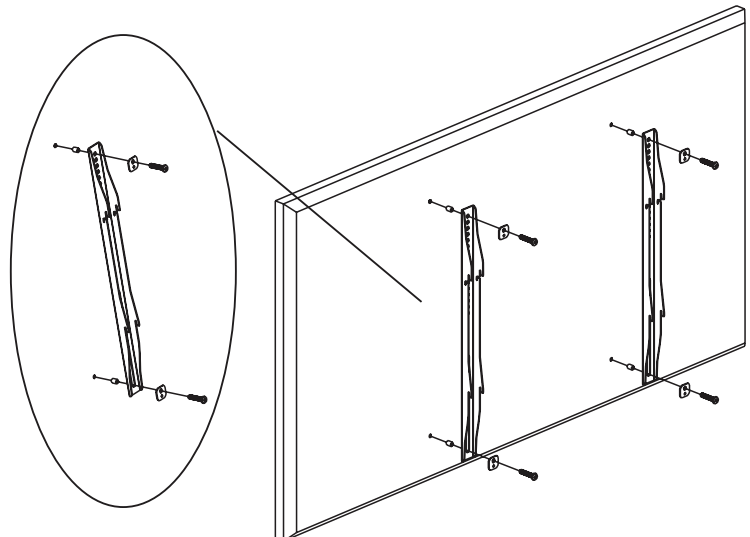

Hang the TV on the Wall Plate

Carefully lift the TV to hook the arms over the top lip of the wall plate. Allow the lower portion of the arms to swivel in under the bottom lip of the wall plate. Do not release the TV until it is completely seated.

Adjustments

Forward Tilt Adjustment (SB-WM-T-M-BL only)

Using the included long hex wrench, loosen the tilt adjustment locks (circled) on the sides of the arms enough to allow movement.

Set the tilt to the desired angle, then tighten the locks. If the locks cannot be tightened enough, remove the TV from the wall for better access.

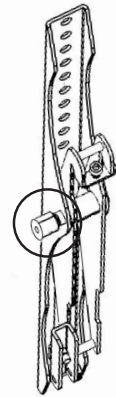

Horizontal Adjustment

The arms feature tilt adjustment screws to help fine-tune the display's alignment. Use provided hex wrench to adjust the screw for perfect leveling.

Pro Tip: Due to display weight, it may be easier to lift the panel slightly while adjusting the screw.

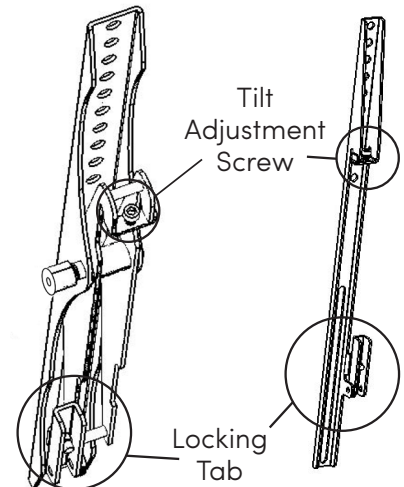
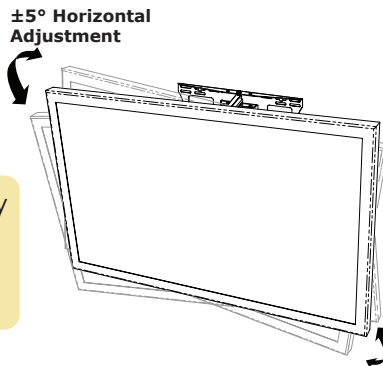

Locking

To lock the arms to the wall bracket, twist the locking tabs until the edge catches behind the bracket. The hex wrench can be used as a tool to help with this step. Add a padlock (not included) if desired.

Technical Support

For technical support, please call 866-357-8688 or visit <https://www.sunbrite.tv.com/support/services/contact-support>, fill out the support request form, and our support team will respond via email.

Visit tech.control4.com/technician for discussions, instructional videos, news, and more.

Warranty and Legal Notices

Find details of the product's Limited Warranty and other resources such as regulatory notices and patent and safety information, at [snapone.com/legal](https://www.snapone.com/legal) or request a paper copy from Customer Service at 866.424.4489.

Copyright ©2022, Snap One, LLC. All rights reserved. Snap One and its respective logos are registered trademarks or trademarks of Snap One, LLC, in the United States and/or other countries. Control4 and SunBriteTV are also registered trademarks or trademarks of Snap One, LLC. Other names and brands may be claimed as the property of their respective owners. Snap One makes no claim that the information contained herein covers all installation scenarios and contingencies, or product use risks. Information within this specification subject to change without notice.

220308-1020

Part # 200-SB-WM-F-T-M-BL-A