



**SM-CEILING-SCA-WH**  
**Strong™ Suspended Ceiling Tile Adapter Plate**  
**(White)**



**Install Guide**

## Parts included

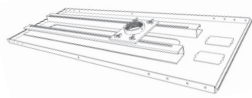

Ceiling tray (x1)



Hex wrench, 2.5mm (x1)



Support Wire,  
5' (x4)



Flush mount  
tube (x1)

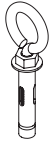

Concrete anchor  
(x4)



Cable clamp (x8)



Turnbuckle (x4)



Eye bolt (x4)

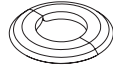

Escutcheon (x1)



M5 x 5mm  
set screw (x4)

## Warnings

- Installation by a qualified professional is highly recommended.
- Do not begin installation until these instructions have been thoroughly read and understood.
- This ceiling plate supports a maximum load of 100 lbs (45.5 kg).
- The manufacturer does not accept responsibility for incorrect installation.

## Tools required

- Power drill
- Screwdriver, Philips head
- 5/32" (4mm) Drill bit
- 13/32" Socket head wrench

# Installation instructions

## Important pre-assembly information:

The Ceiling Tray is designed to fit above a 24" (610 mm) x 24" (610mm) or 24" (610mm) x 48" (1220mm) conventional suspended ceiling. Ceiling runners should have a "T" cross-section and a minimum height of 1.5" (38 mm).

For certain installations, ceiling anchors may need to be installed (Step 3) before the ceiling tray (Step 1).

## Step 1: Install the Ceiling Tray

- Place the Ceiling Tray in the grid above a 24" x 24" or 24" x 48" false ceiling tile so that lip of Ceiling Tray rests on ceiling runners (Fig 1).
- Slide Collar Mount Plate to desired position. Using hole in Collar Mount Plate, mark the ceiling tile where the hole will be cut. Remove Ceiling Tray and cut out a 2.25" hole in ceiling tile. Slide Collar Mount Plate back into position over cut hole and tighten all Wing Nuts.

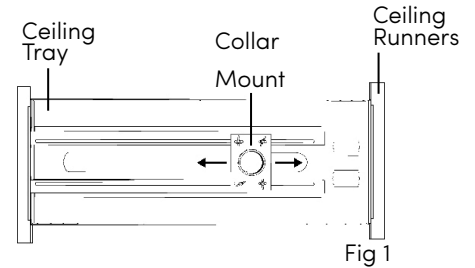

## Step 2: Install the Flush Mount Tube

- From the top, thread the Flush Mount Tube through Retaining Collar in Ceiling Tray and through the Ceiling Tile (Fig 2). Tighten the Set Screw.
- Add Eschutchen for a more finished look.

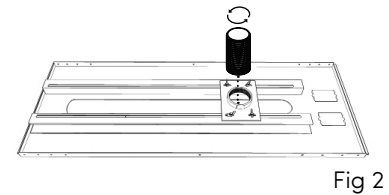

## Step 3: Install the Wire Supports

- Insert Turnbuckle hooks into four corners of Ceiling Tray (Fig 3).
- Pass the support wire through one end of the cable securing clamp, but do not secure it yet.
- Pass the support wire through the turnbuckle hook eyebolt and loop back through the cable securing clamp (Fig 4a). At least 2" (50.8mm) of non-load-bearing cable must extend from the clamp as shown by locator 1 in Fig 4b. Secure the clamp tightly using at least 1 N•m (8.85 in-lb) of torque (Fig 4b).
- Depending on mounting surface, perform the appropriate procedure below.

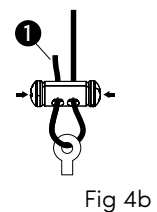
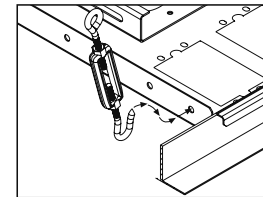

### Wood Joists or Beams:

Drill 5/32" (4 mm) diameter holes 2" (51 mm) deep.

Fully insert the eye bolts (Fig 5).

After installing the anchors, pass the remaining support wire through one end of the cable clamp and loop the upper end through the anchor's eye. Pull the support wire tight and secure it using the cable clamp. Tighten the clamp using at least 1 N•m (8.85 in-lb) of torque.

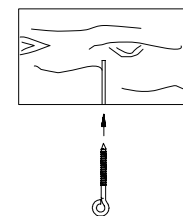

(Continued on next page)



## Truss Ceiling:

No anchor required. After attaching the support wire to the turnbuckle, pass the remaining support wire through one end of the cable clamp and loop the upper end around the ceiling truss. Pull the support wire tight and secure it using the cable clamp (Fig 6). Tighten the clamp using at least 1 N•m (8.85 in-lb) of torque.

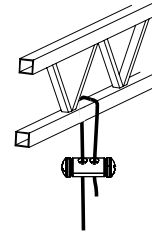

Fig 6

Position the holes so when the support wires are attached and taut, the optimal angle is 15°. Unit may be mounted at an angle up to 45° if necessary.

**Caution:** Do not extend two wires together - use one continuous wire.

## Step 4: Install Extension Pole (optional)

- If installed, remove the Flush Mount Tube.
- From the bottom up, thread Extension Column (not included) up through Retaining Collar in Adjustable Collar Mount Plate. Fasten with a Set Screw using the Allen Wrench (Fig 7).

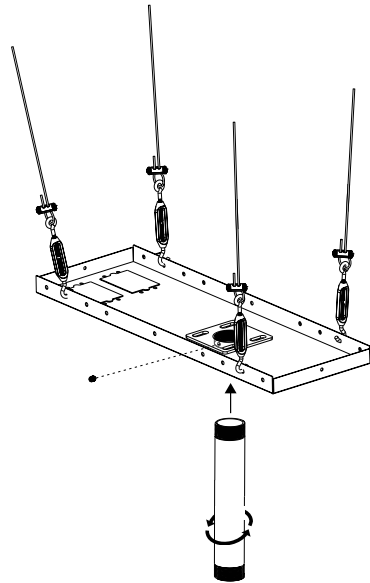

Fig 7

## Warranty and Legal Notices

Find details of the product's Limited Warranty at [snapone.com/legal/](https://snapone.com/legal/) or request a paper copy from Customer Service at **866.424.4489**. Find other legal resources, such as regulatory notices and patent and safety information, at [snapone.com/legal/](https://snapone.com/legal/).

Copyright ©2023, Snap One, LLC. All rights reserved. Snap One its respective logos are registered trademarks or trademarks of Snap One, LLC (formerly known as Wirepath Home Systems, LLC), in the United States and/or other countries. Strong is also a registered trademark or trademark of Snap One, LLC. Other names and brands may be claimed as the property of their respective owners. Snap One makes no claim that the information contained herein covers all installation scenarios and contingencies, or product use risks. Information within this specification subject to change without notice. All specifications subject to change without notice.