



MantelMount®

MM860 Installation Instructions

IMPORTANT SAFETY INSTRUCTIONS - SAVE THESE INSTRUCTIONS

Please read this entire manual before you begin.

Do not unpack any contents until you verify all requirements on PAGE 3.
If you have any questions, visit MantelMount.com or call (800)-897-9755.

⚠ WARNING!

This product contains small parts that can be a choking hazard. *Do not* let children play with any of these small parts! Keep children away from the work area during installation.

⚠ WARNING!

Do not let children operate, pull on, or hang from MantelMount.

Do not operate MantelMount when anyone is near or behind the mount. MantelMount is very strong and can result in crushing injuries.

⚠ WARNING!

MantelMount must be installed to a wall or structure that is able to hold five times the combined weight of all equipment. If you are unsure about your structure, a contractor must evaluate your installation.

⚠ WARNING!

Exceeding the weight capacity can result in serious personal injury or damage to equipment!
The combined weight of all components must not exceed 125 lbs (57 kg).

⚠ CAUTION:

This product is intended to be installed by professional installation contractors, or persons familiar with the tools and methods required for this installation. If you are not sure about your ability to perform this installation, you must contact a professional. MantelMount is not responsible for damage or injury caused by incorrect installation or improper use.

⚠ CAUTION:

Do not use this product in any way, or for any purpose, that is not specifically described in these instructions. MantelMount is not responsible for damage or injury caused by incorrect installation or improper use.

U.S. Pat. No. 8,864,092
Other Patents Pending

IMPORTANT:

MantelMount has three different adjustments that must be made after the installation is complete in order to operate properly.

The side-to-side swivel stops are adjusted with two screws with locknuts so that the TV does not swivel into the mantel.

Tilt and yaw are removed using four screws behind the swivel mechanism. The TV should always be flat to the wall when stowed.

The bottom travel stop is adjusted with two screws and locknuts so the TV and mount do not lower all the way into the mantel.

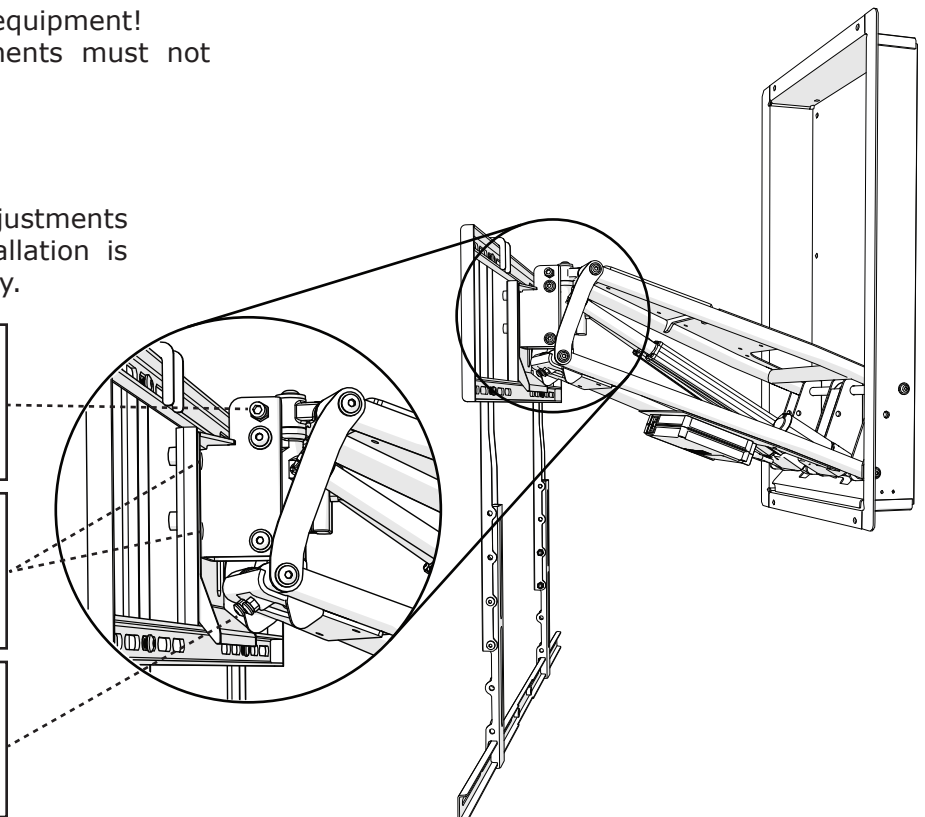

Required Tools

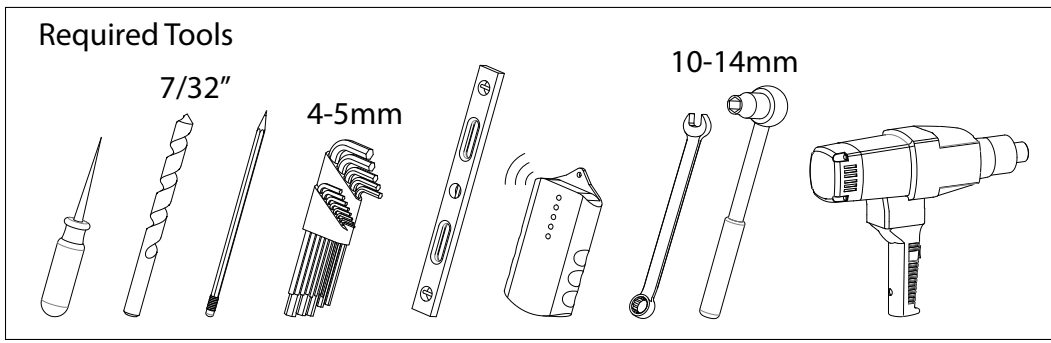

Before you begin, please verify that all components are included and undamaged. If any parts are missing or damaged, contact MantelMount. Never proceed with missing or damaged parts! Lay out all components and make sure you identify that each one has a match in the diagram. Some of the parts included will not be used during installation. Do not proceed if you do not understand and identify all of the components.

Silver Screws for back of TV

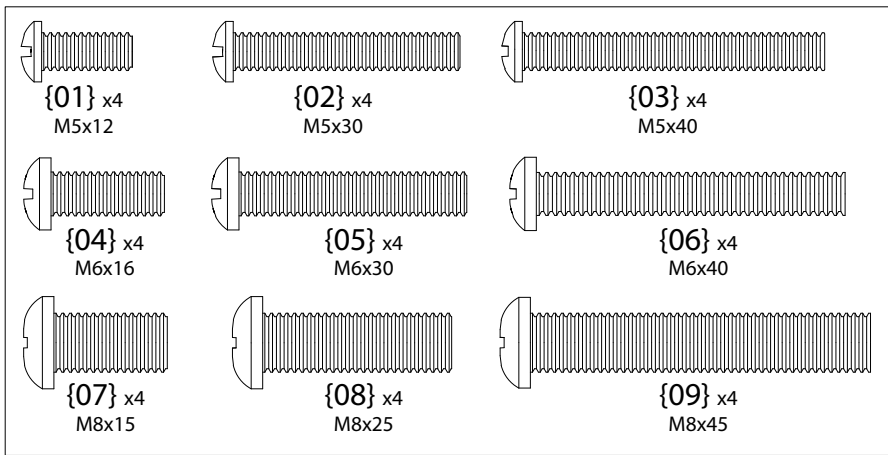

Black Parts for Mount

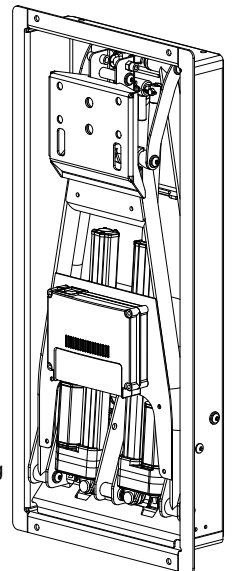
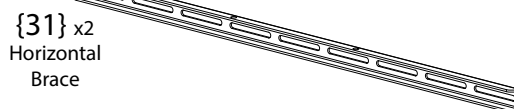
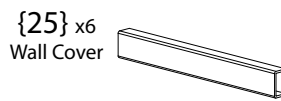
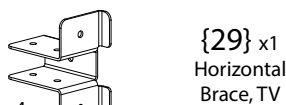
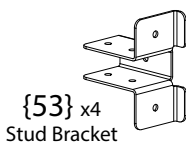
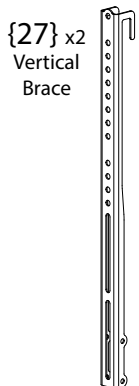
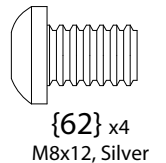
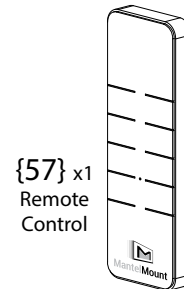
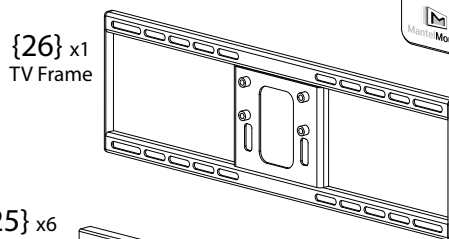
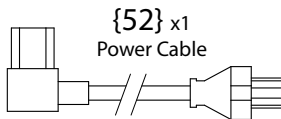
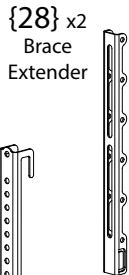
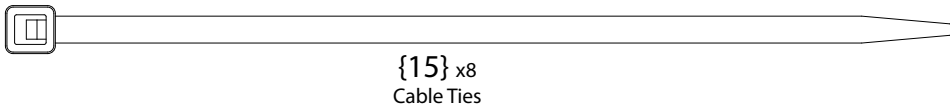
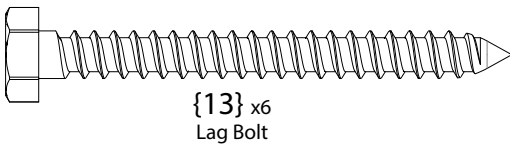
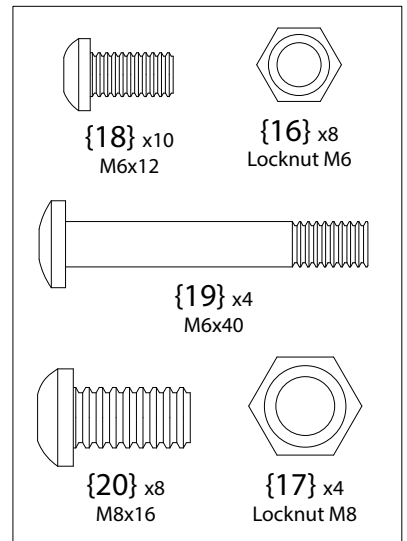
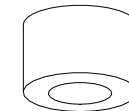
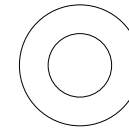
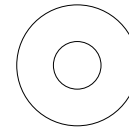

Please verify that your installation meets all of these CRITICAL requirements:

A MantelMount is designed for use only with decorative fireplaces that are not the primary heat source for a house. Temperature at the front edge of mantle should never exceed 110° F.

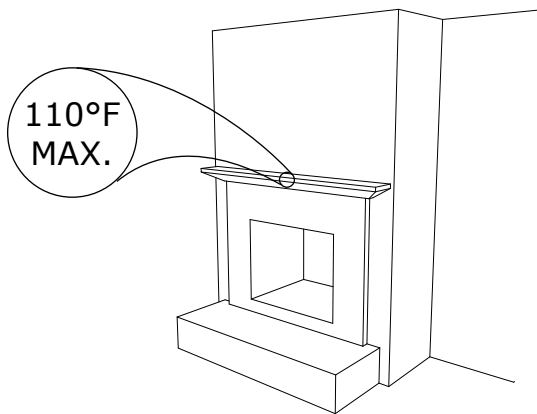

B Wall must be WOOD STUD FRAME only. There must be at least 2 studs available for mounting. Wall covering must not exceed 5/8 inch thick.

For other types of walls or other types of installations please visit the FAQ section at www.MantelMount.com.

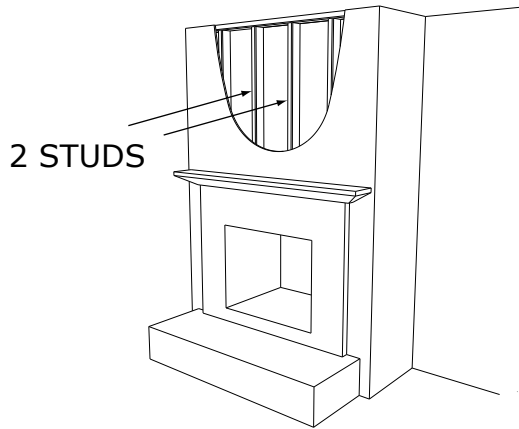

C Mantle must not extend from mounting surface more than 19 inches (22 inches for non-recessed installations). MantelMount can not extend past a mantel larger than 19 inches. Larger mantels will also reduce the amount of side-to-side swivel.

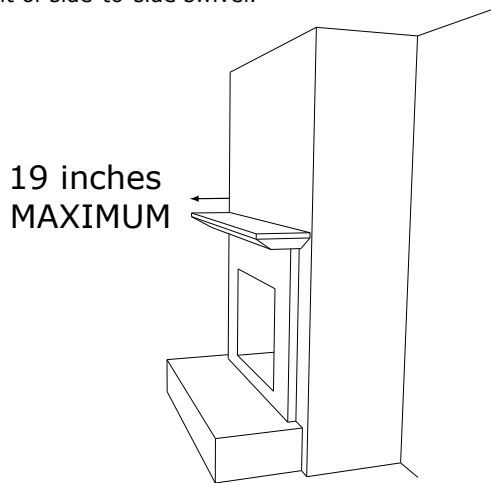

D TELEVISION REQUIREMENTS:
 1. Weight must be below 125 pounds (56 Kg).
 2. Screen size larger than 50 diagonal inches.
 3. Mounting screw holes are VESA compliant.
 For non-VESA hole patterns, please visit the FAQ section at www.MantelMount.com.

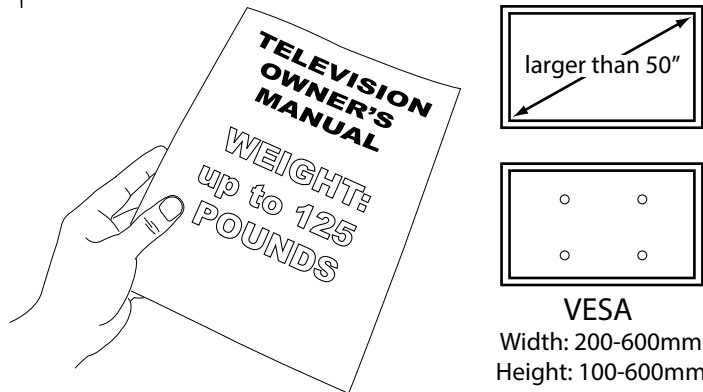

E The space above the mantle must be taller than the TV. The required space depends on how far out the mantle extends. Refer to chart below and add this additional height to the TV height to determine if space is tall enough.

TV height must include the height of the Sound Bar if one is being used.

If mantle extends:	Required Clearance:
Less than 10 inches	Add 5 inches
10 - 12 inches	Add 6 inches
12 - 14 inches	Add 8 inches
14 - 17 inches	Add 11 inches
17 - 19 inches	Add 14 inches

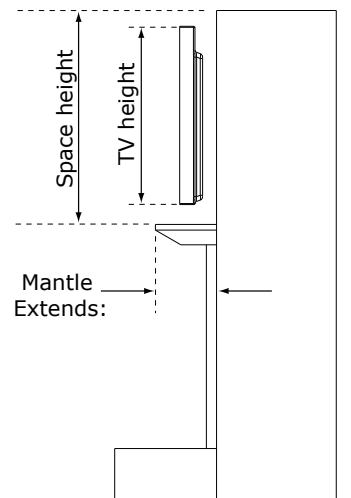

- 1** Use a Vertical Brace {27} to determine if your television is a flat back or an irregular back. An irregular back will require spacers and longer screws to fill any spaces between the Vertical Brace and the TV. The Braces must be parallel to your television screen.

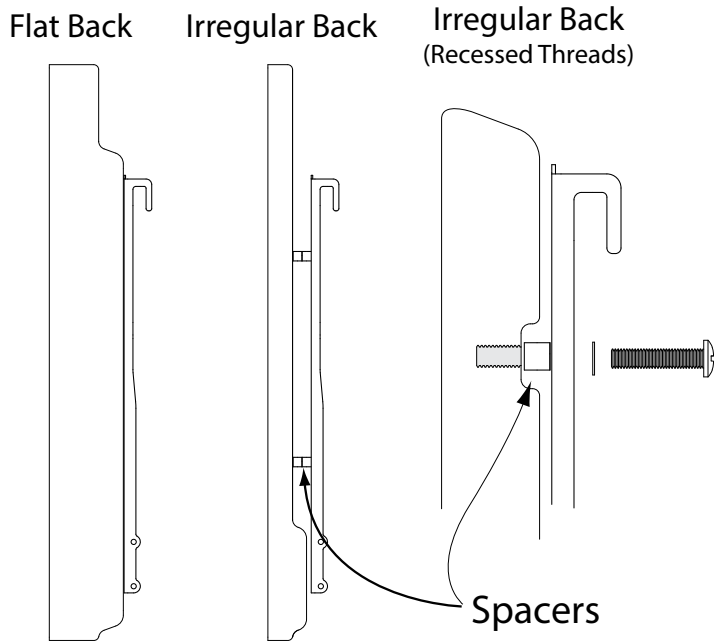

- 2** Choose the correct screw diameter and length for the TV. Hand-thread screw combination into the TV to ensure there is adequate thread engagement without hitting the bottom of threaded insert. Use only minimum amount of spacers (if required).

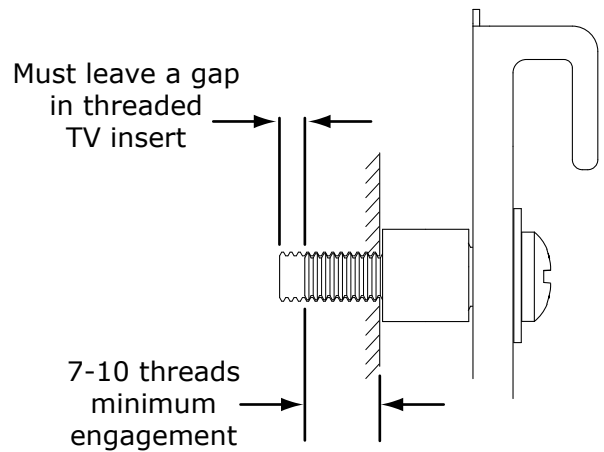

CAUTION:

Do Not use screws that are too long for the threaded inserts of Television. This can damage internal components.

- 3** Possible Screw Combinations shown with **maximum** spacer usage (if spacers are required).

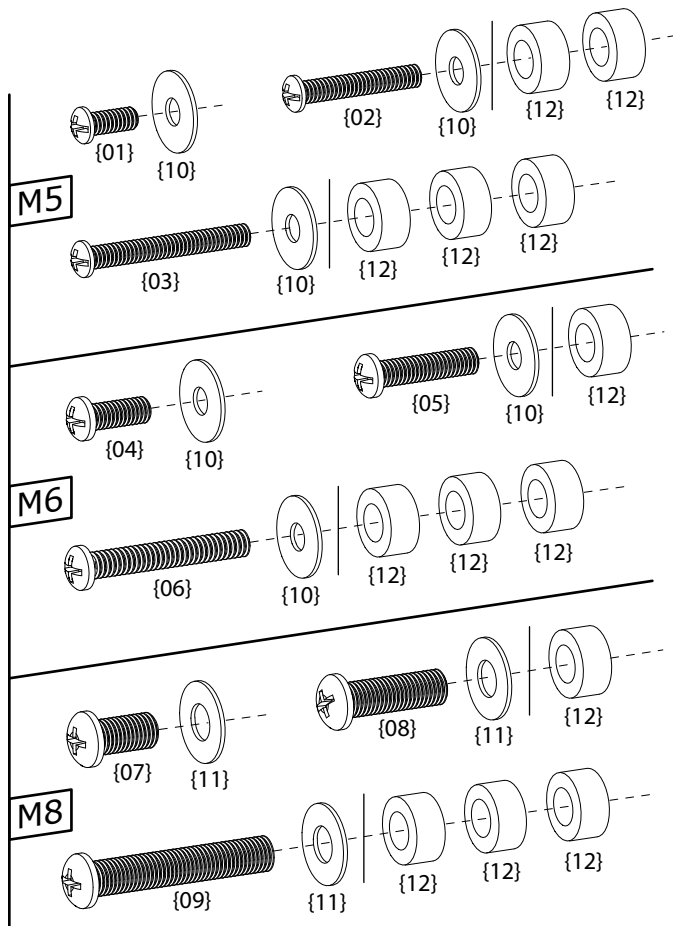

- 4** IMPORTANT INFORMATION: The Vertical Braces {27} are a fixed distance (8 inches) higher than the bottom of the Lift Housing {30}. Always mount the Vertical Braces at least 8 inches up from the bottom of the TV so that the TV will hide the mount when it's in the UP position.

If you want to locate the TV at a specific height, you can use this relationship to calculate the exact location for the Lift Housing {30} on the wall. Simply subtract 8 inches from the distance you end up with when you attach everything to the TV - including a sound bar if one is attached.

EXAMPLE: If the Vertical Braces {27} are 10 inches above the bottom of the TV, then the edge of the Lift Housing {30} will be: $(10 - 8 = 2)$ inches higher on the wall than the TV.

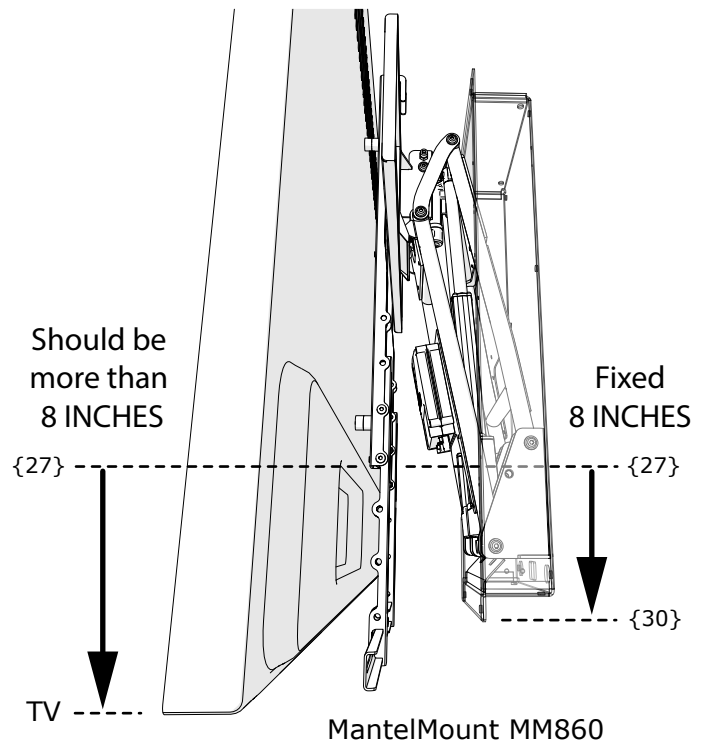

5 The Vertical Braces {27} are always mounted higher than the bottom of the TV. However, the Brace Extenders {28} will be mounted one of two ways:

Without a Sound Bar, if needed - The Brace Extenders are installed slightly **above** the bottom of the TV. Use the Extenders for holes that are low on the TV.

With a Sound Bar - The Brace Extenders are installed **below** the TV with enough room to install the Sound Bar onto Horizontal Brace {29}. Or use Sound Bar Wings {59}.

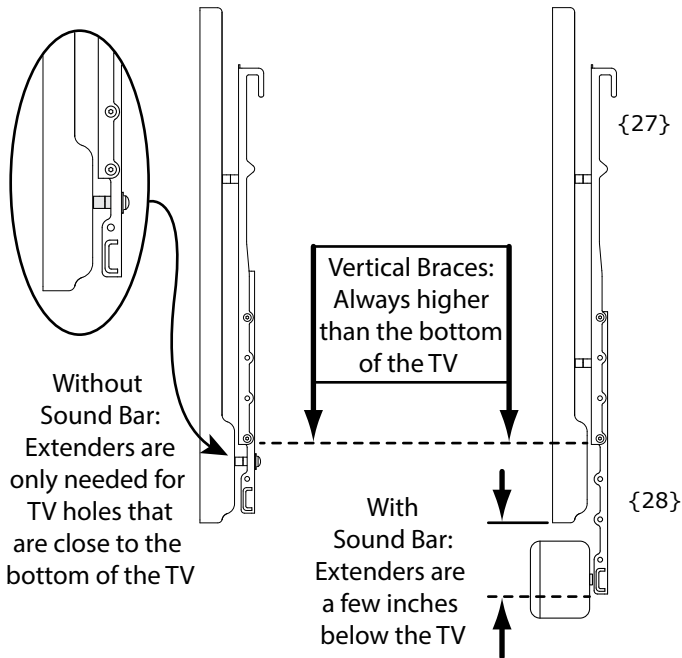

6 Attach the Vertical Braces {27} to the TV so the bottoms of the Vertical Braces are at least eight inches higher than the bottom of the TV (so that the TV hides the mount housing).

NOTE: If all the screws for the back of the TV can fit into the TV Vertical Braces {27}, and a Sound Bar is not being used, then the Brace Extenders {28} do not need to be installed.

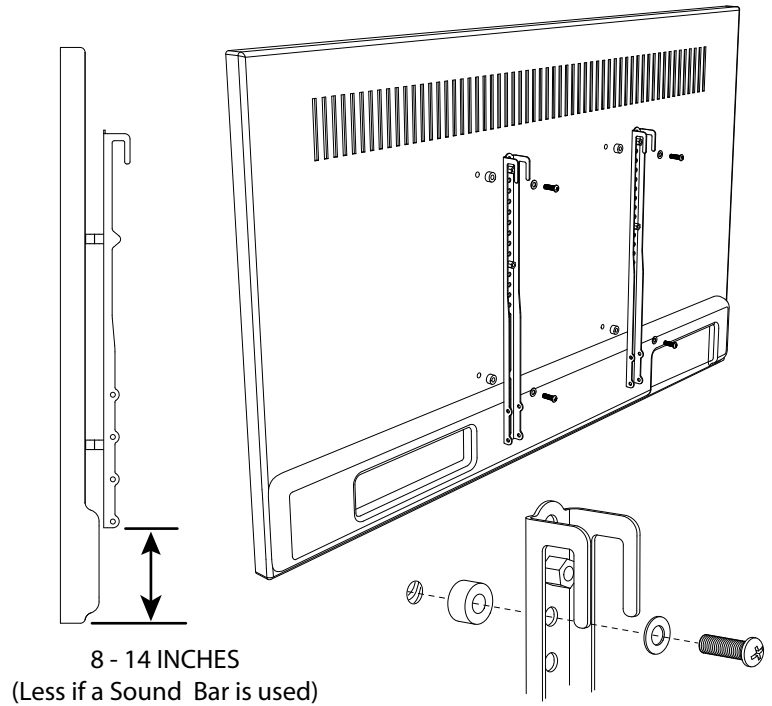

7 Attach the TV Horizontal Brace {29} with Screws {18} if a Sound Bar is used. Each Extender {28} must be slid onto the Brace from the outer ends because there are thread inserts blocking the center of the Brace.

Attach the Extenders to the Vertical Braces using Screws {19} and Nuts {16}. Sound Bar Wings {59} are optional.

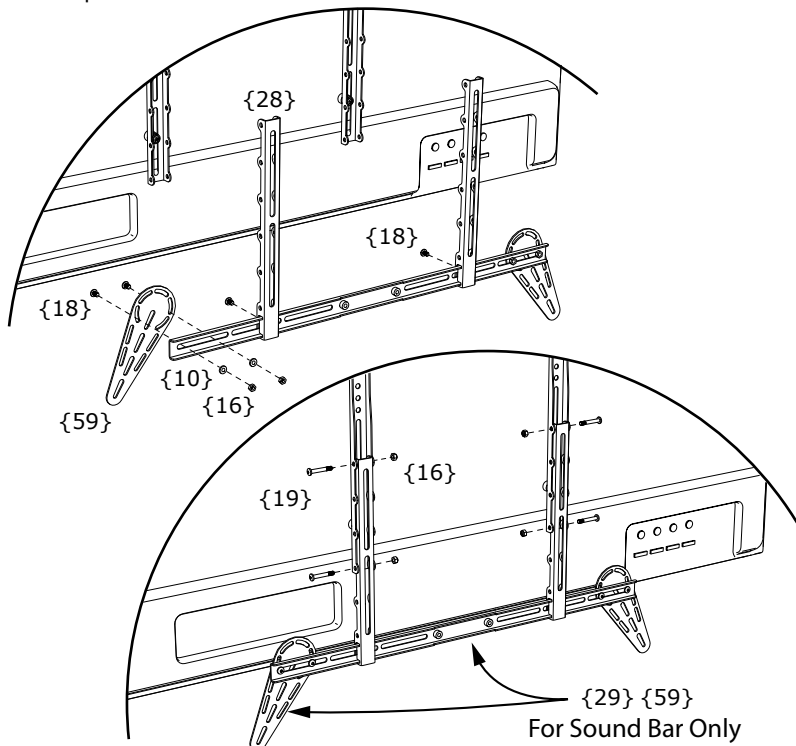

MantelMount MM860

8 Measure the distance from the bottom of the Vertical Braces {27} (not the Extenders) to the bottom of television or Sound Bar.

Write down this distance to use in Step 9.

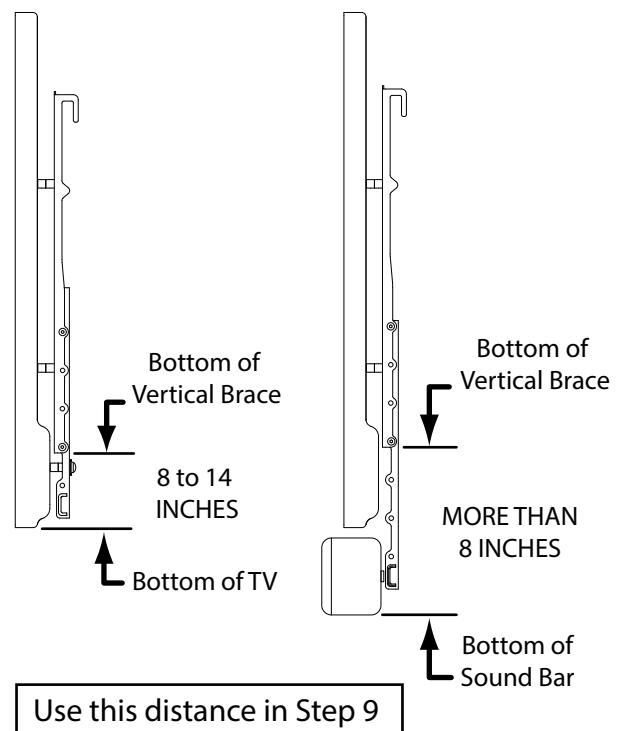

9 Determine the Vertical Position of the Housing:

The image below shows that the further out a mantle extends, the more it will interfere with the arc of the lowering TV. The MM860 Lift Housing {30} must be installed high enough to clear the mantle when it lowers. Larger mantels require higher installations.

Use the two measurements specified to reference the Look-up Chart below and obtain the minimum installation height for the Housing. This will be the closest distance that the bottom of the TV (or sound bar) can be installed above the mantle.

NOTE: If there is extra space available, due to a high ceiling for example, then these heights are only *minimum* requirements.

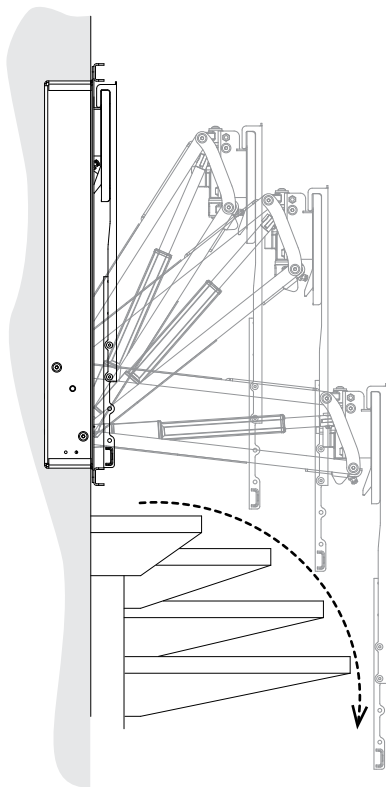

MEASURE THIS DISTANCE
(with or without soundbar)
Must be 8" Minimum
see: Step 8

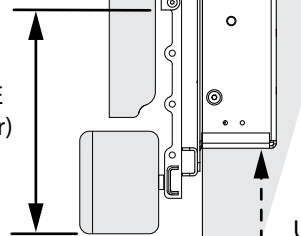

Use the chart below to find
the installation height
for the Housing

USE THIS DISTANCE
For STEP 12

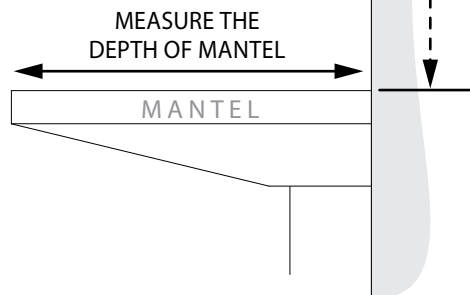

DEPTH OF MANTEL →

DISTANCE From STEP 8:	DEPTH OF MANTEL →											
	8" OR LESS	9"	10"	11"	12"	13"	14"	15"	16"	17"	18"	19"
8"	4.00"	4.25	4.75	5.25	5.75	6.50	7.50	8.50	9.50	11.00	12.50	14.50
9"	5.00"	5.25	5.75	6.25	6.75	7.50	8.50	9.50	10.50	12.00	13.50	15.50
10"	6.00"	6.25	6.75	7.25	7.75	8.50	9.50	10.50	11.50	13.00	14.50	16.50
11"	7.00"	7.25	7.75	8.25	8.75	9.50	10.50	11.50	12.50	14.00	15.50	17.50
12"	8.00"	8.25	8.75	9.25	9.75	10.50	11.50	12.50	13.50	15.00	16.50	18.50
13"	9.00"	9.25	9.75	10.25	10.75	11.50	12.50	13.50	14.50	16.00	17.50	19.50
14"	10.00"	10.25	10.75	11.25	11.75	12.50	13.50	14.50	15.50	17.00	18.50	20.50
15"	11.00"	11.25	11.75	12.25	12.75	13.50	14.50	15.50	16.50	18.00	19.50	21.50

CAUTION:

MantelMount MM860 comes with an RF Remote Control. This Remote does not need to be pointing at the mount in order to control the mount; in fact, the Remote will send commands to the mount even from other rooms in the house. It is very important to operate the Remote only when the mount is in sight. Otherwise, always store the Remote in a safe place away from children.

* Press any button to immediately stop mount movement *

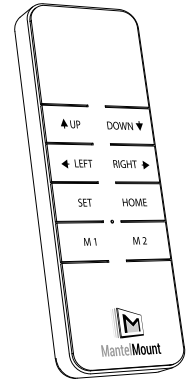

MantelMount RF Remote Control

JOGGING BUTTONS:
Press and hold any of these four buttons for continuous movement.

Hold to Raise the Mount

Hold to Swivel Left

Set Soft Stops and Memory Positions

Press for Memory 1 Position

PRESS BUTTONS:
Single-Press any of these four buttons for automated function.

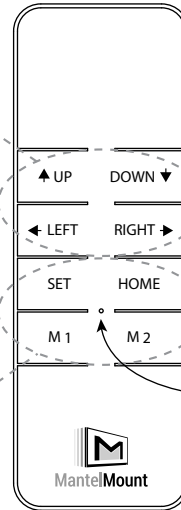

Hold to Lower the Mount

Hold to Swivel Right

Press to Fully Raise the Mount

Press for Memory 2 Position

Blue Indicator Light

Can be programmed with the SET button

Note:
Setting the Soft Stops with the SET button can only be done when the mount is in "Program" mode. See Page 11.

10 Pairing the Remote to MantelMount:

To start using the MantelMount MM860, the Remote Control must be linked to the mount. This process is called "Pair". To pair the Remote, follow these steps:

- Press any button on the Remote to verify the blue light works.
- Attach Power Cable {52} to the mount and plug into wall outlet.
- On the bottom of the electronics housing, press the "Program" Button for 3 seconds until the green Status light rapid blinks.
- Press and release the SET button on the remote. Pairing is complete and is confirmed if the Status light stops blinking.

11 Verify Proper Remote Operation:

Lay MantelMount on a flat, stable surface. Press and hold the DOWN button on the Remote until the arm is perpendicular to the Housing. Operate the LEFT and RIGHT buttons to verify the swivel operation. Return the arm to the HOME position before installation.

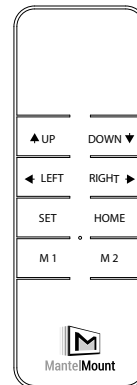
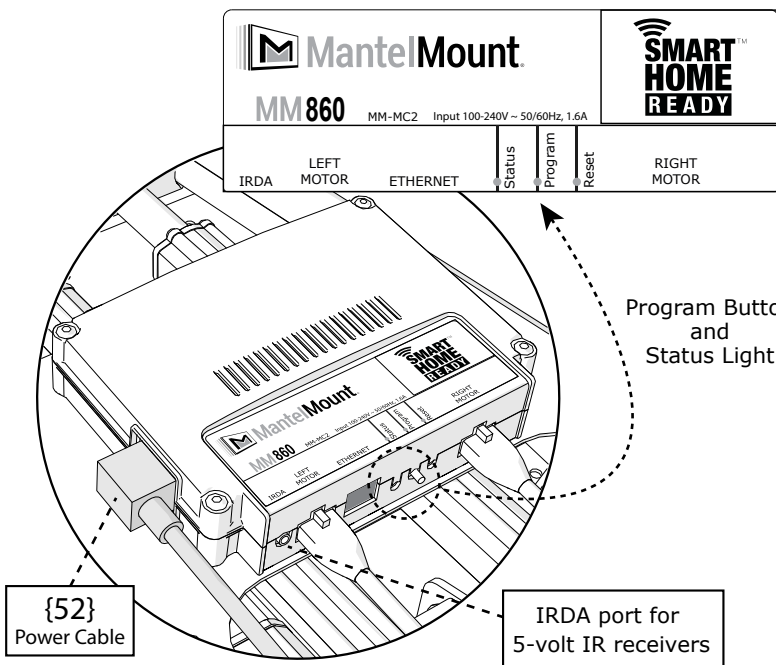

Down Button:
Opens the Mount

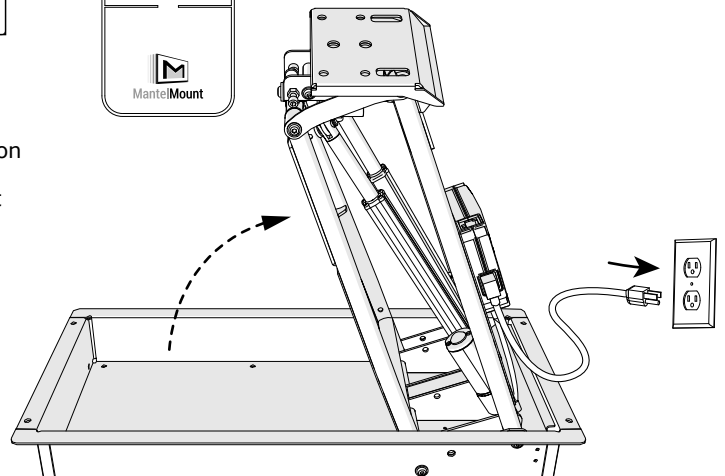

OPTIONAL:

Auto Lowering Power Sensor (ALPS):

This unique MantelMount feature will allow the mount to lower to the the Memory 1 position whenever the TV is turned on, and return home when the TV is turned off. The mount will do this automatically without needing to use the Remote Control.

If the TV is plugged into the socket located onboard the MM860 instead of a wall outlet, MantelMount can monitor the power to the TV and determine when the TV is turned on or off.

If this feature is not desired, simply plug the TV into a wall outlet and operate the MM860 with the Remote Control.

ALPS WILL NOT WORK IF ANY OTHER DEVICES OR POWER STRIPS ARE PLUGGED INTO THE ALPS SOCKET.

See STEP 27:

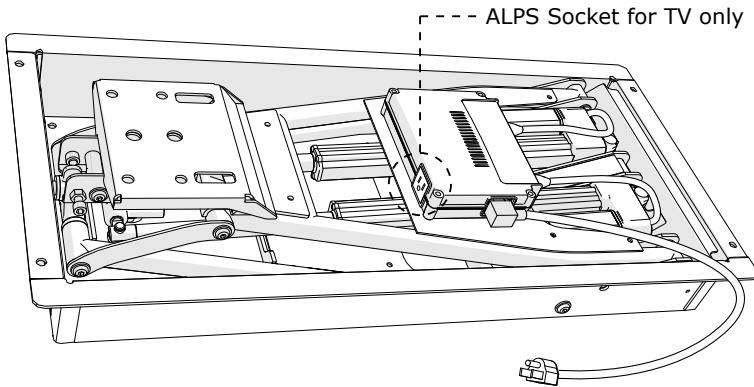

OPTIONAL:

Hard Wire Conduit Access:

MM860 has rear access holes that accept standard knock-out fittings for 1/2" aluminum conduit. A licensed electrician can hard wire an AC power socket or splice into the power cord.

Contact MantelMount for more information.

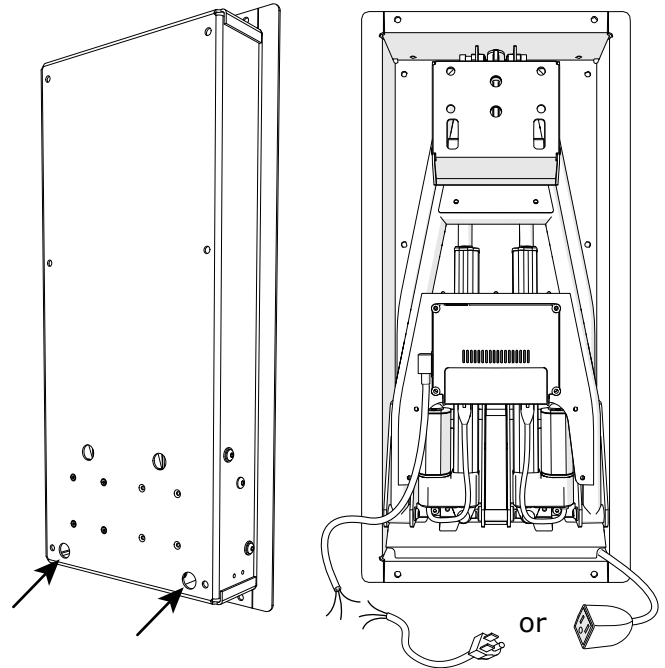

OPTIONAL: Adapter Brackets for 2x4 bracing:

MM860 includes brackets that make it easier to install horizontal 2x4 bracing inside the wall. This is because all the attachment holes in the brackets can be reached for drilling and screwing through the opening that is cut for the Lift Housing {30}, see FIG. A.

Notes: If the bracket is near the cutout opening, make sure to orient the attaching hardware away from the opening so they do not interfere with the Housing. This hardware is attached before the braces are installed into the wall, see FIG. B.

When cutting a center stud, measure 1.5" above and below the template mark before the opening is cut out. Plunge cut through the stud at both locations and attach the cut ends to the cross braces when they are installed, see FIG. C.

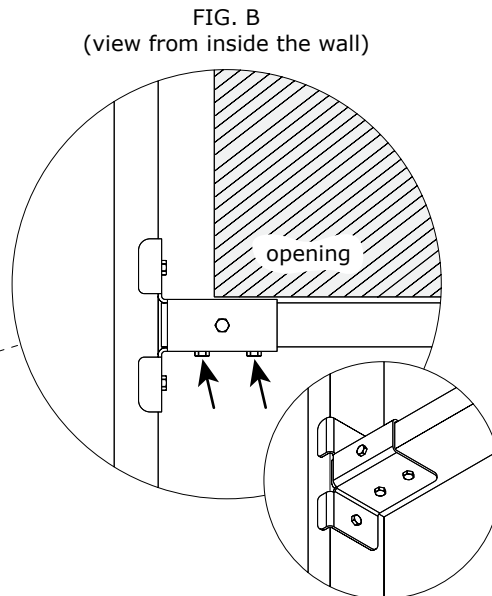
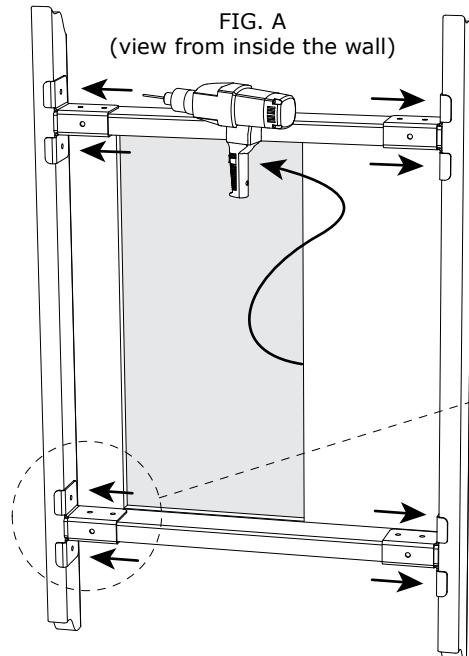
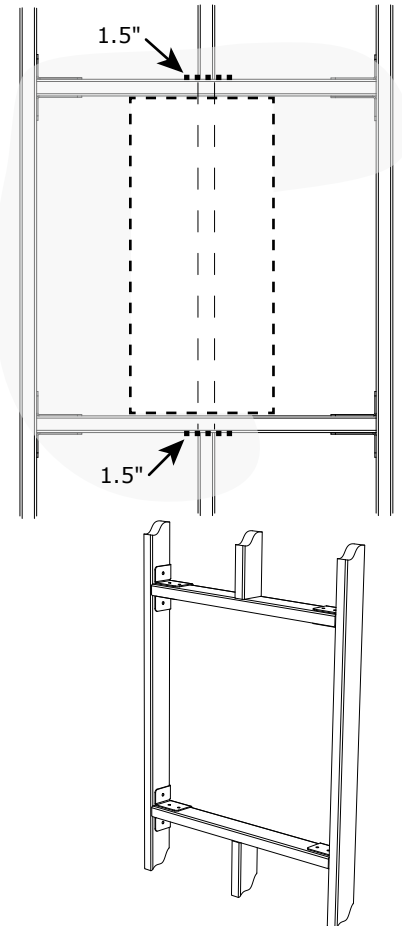

FIG. C
(view facing the wall)



Installation Options:

SURFACE MOUNT (non-recessed) installation using the Horizontal Braces {31} to attach to existing wall studs:

The Horizontal Braces can reach studs that are up to 34 inches (875mm) apart. They attach flush to the back of the Lift Housing {30}.

⚠ CAUTION:

Do Not overtighten Lag Bolts {13}. Tighten only until the washers are firmly against the wall plate. Damage due to overtightening can cause property damage or injury.

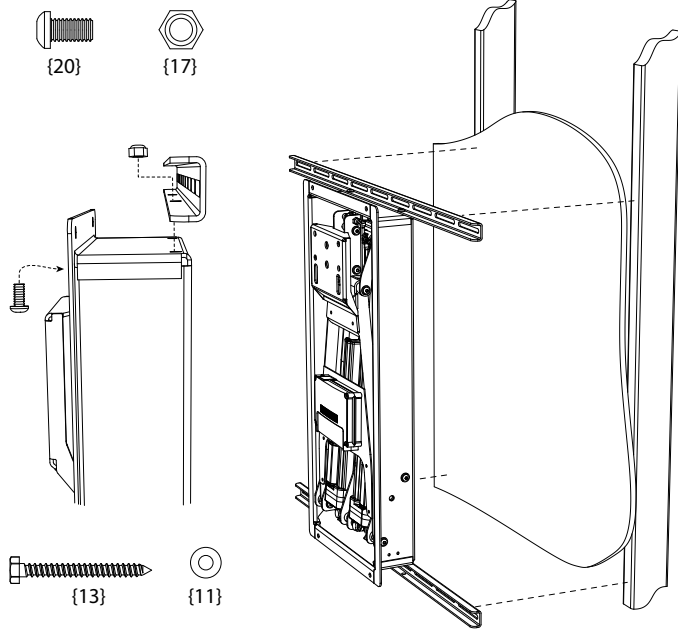

SURFACE MOUNT (non-recessed) installation onto stone or concrete walls using the six holes in the back of the Recess Frame {30}. The lower Access Cover {32} must be removed to access the lower holes.

The wall must be solid stone or concrete that can hold five times the weight of all combined equipment. This surface must not be a facade or non-structural material. Use concrete anchors (not included) to attach mount to surface.

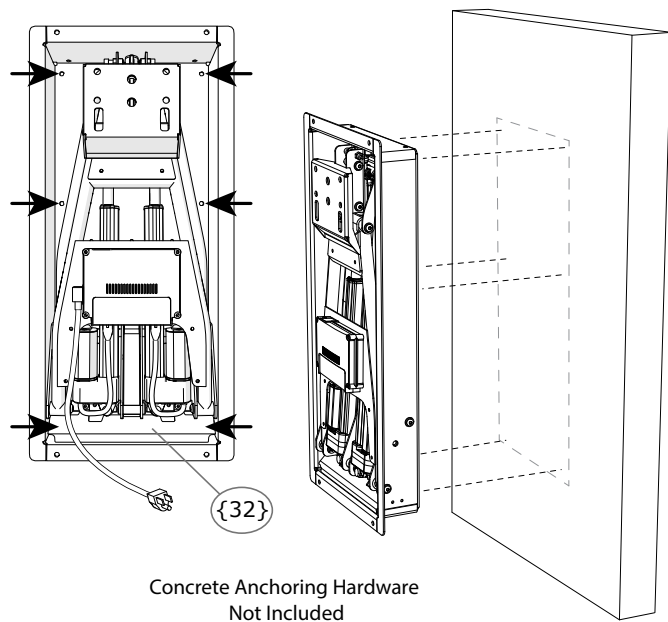

RECESSED installation using the Horizontal Braces {31} to attach to existing wall studs:

The Horizontal Braces attach to the flange on the front of the Lift Housing {30}. Use the included Template to mark the location to cut the drywall. This installation is easiest when there is no center stud that needs to be cut to make room.

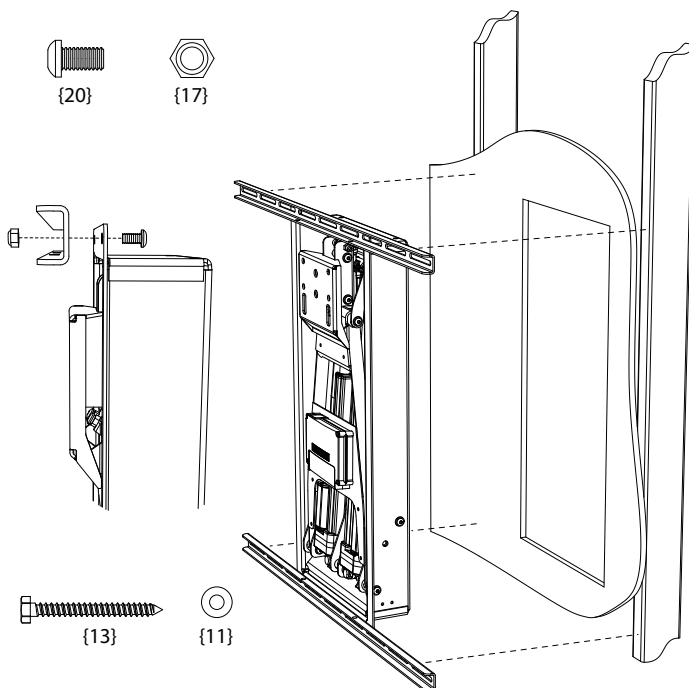

RECESSED installation using the included 2x4 Stud Brackets {53}.

When studs are far apart, when a center stud needs to be cut, or when the cleanest look is desired, sections of horizontal 2x4 can be installed through the cutout. They provide a solid structure for the mount without the need for the Horizontal Braces. The mount is attached with Lag Bolts through the holes in the front flange of the Lift Housing {30}. Any studs that were cut can be reattached to the new sections of 2x4.

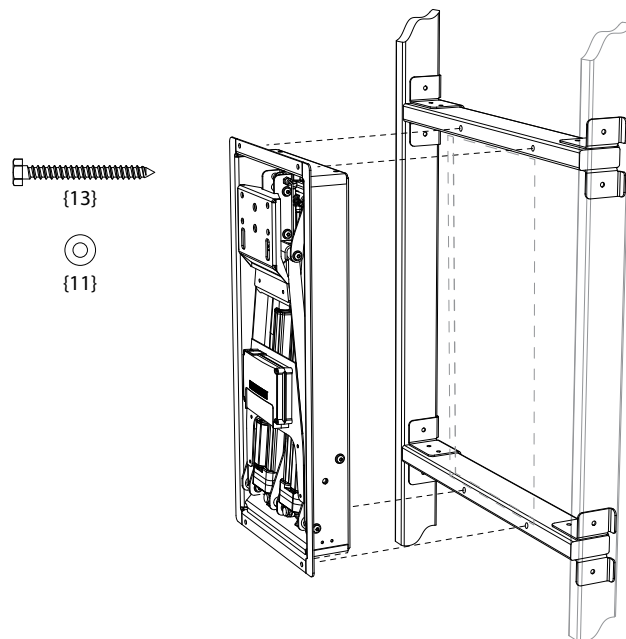

12 Install the Lift Housing {30}

RECESSED: Trace the Cardboard Template vertically onto the wall about the centerline at the correct height from Step 9. Use a level to ensure the cutout is plumb.

NON-RECESSED: Use the Cardboard Template to mark the location of the Housing. MantelMount is located in the same spot for all installations.

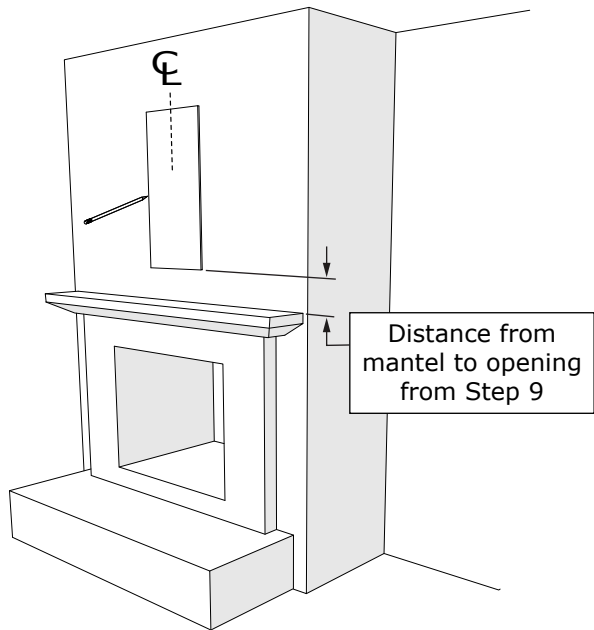

13 After the Lift Housing is installed and power is connected, press and hold the DOWN button on the Remote to lower the Arm to horizontal. DO NOT lower past horizontal in order to avoid hitting the mantel.

DOWN Button:
Lowers the Mount

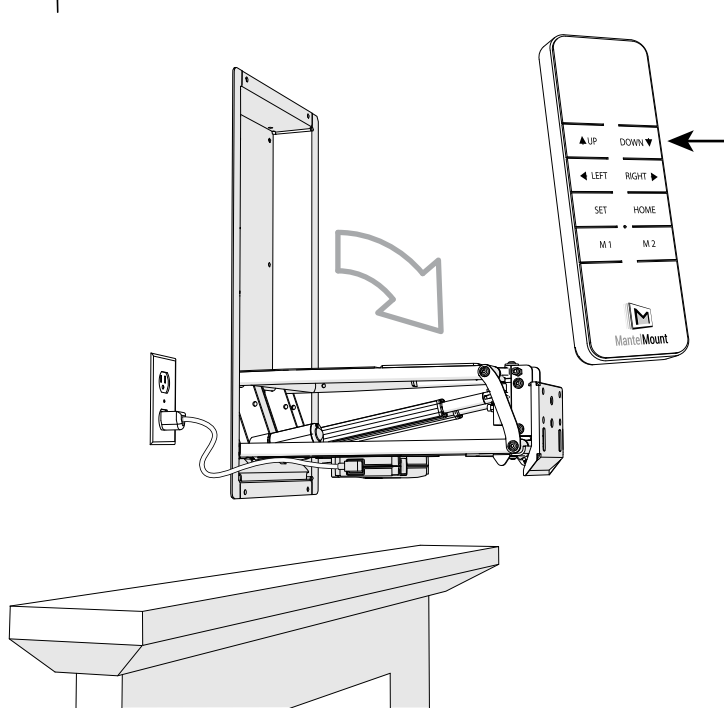

14 ⚠️ WARNING:

DO NOT put hands into Lifting Mechanism while operating the mount with the Remote Control.

Install the TV Frame {26} by partially inserting Screws {20} into the TV Frame and then hanging the TV Frame onto the Lift Arm. These screws can also be used to fine tune level the TV. Always remember to tighten.

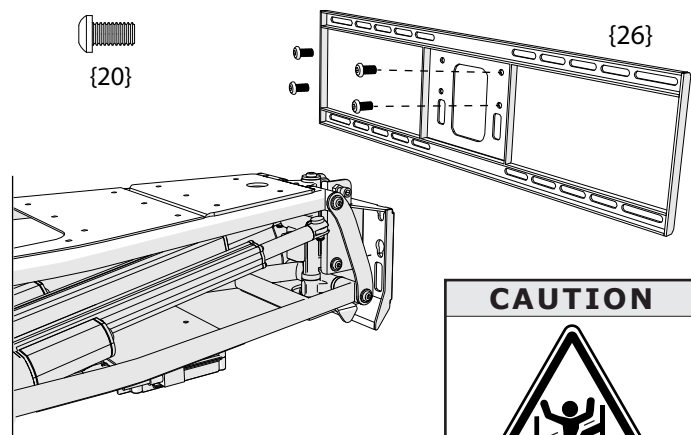

15 THIS STEP REQUIRES TWO PEOPLE

Hang the TV onto the TV Frame. Some older TVs are not weight balanced. If the TV is much heavier on one side, slide the TV slightly sideways to balance and level the TV.

Attach with 4 Screws {18}.

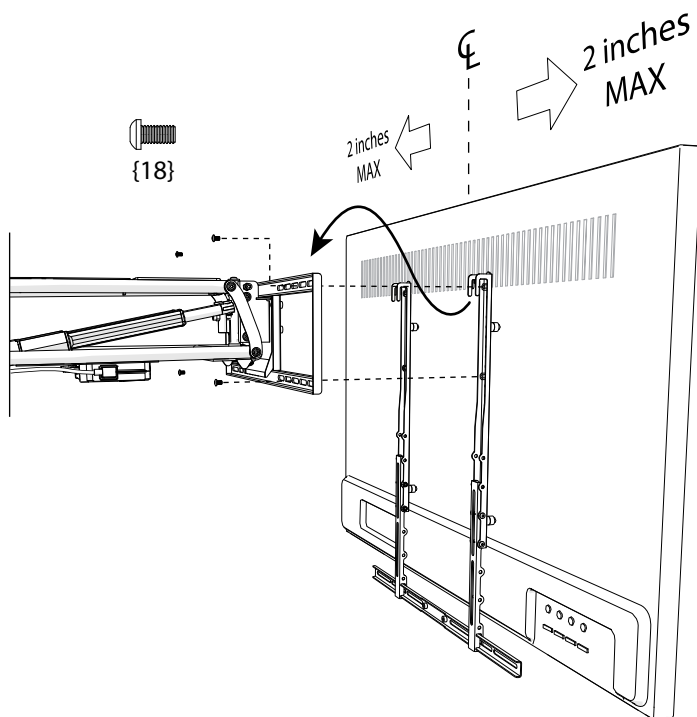

Adjusting the Downward Hard and Soft Travel Stops - FIRST:

16 Adjusting the HARD Bottom Stop Position:

Jog the mount to the maximum safe downward position. Do not swivel the mount sideways. The mount may stop on its own due to the internal limit.

Loosen the Locknuts and adjust the Bottom Stop screws to this position.

Tighten both locknuts after the adjustments are made.

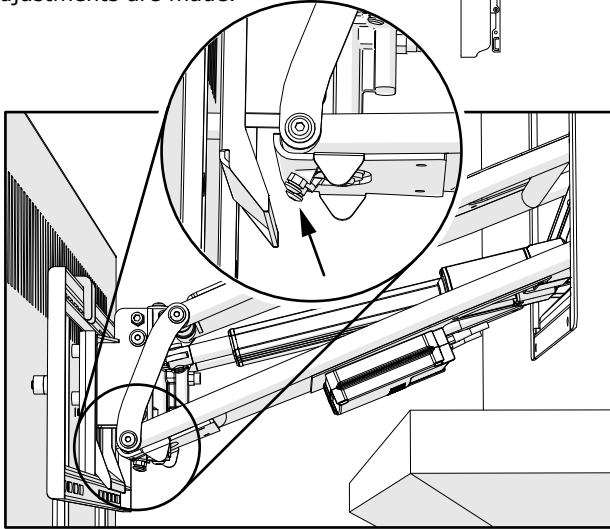

17 Adjusting the SOFT Bottom Stop Position:

a. Once the hard stop is set, jog the mount up slightly from the Hard Stop. This will ensure the mount never hits the Hard Stop. **DO NOT JOG THE MOUNT INTO THE HARD STOP!**

b. On the Electronics Housing, quick-press the "Program" Button and verify that the Status light slow blinks.

c. On the Remote, Press the "SET" button and then within 2 seconds press the "DOWN" button. The Soft Stop should be set. Repeat step (c) if the SET button exceeds the 2 second timeout.

d. Press the Program Button again to exit Program Mode.

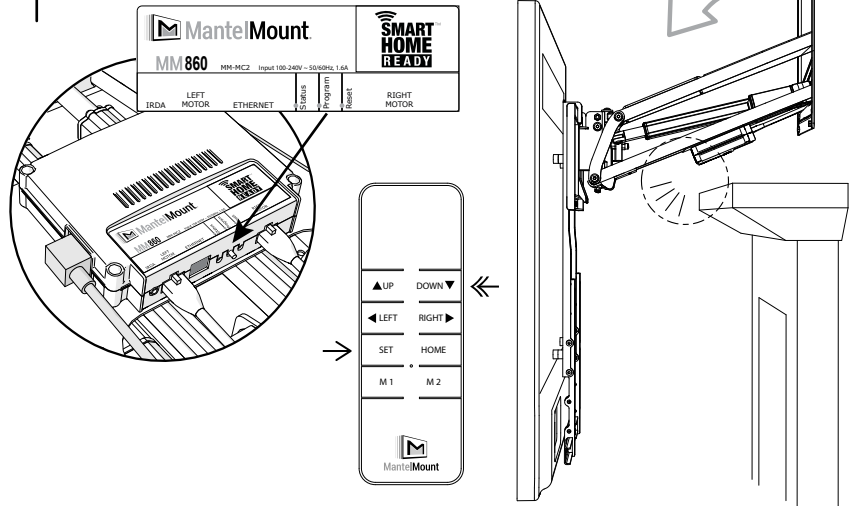

Adjusting the Side Swivel Hard and Soft Travel Stops - SECOND:

18 Adjusting the HARD Side Swivel Stop Positions:

Jog the mount to the maximum safe RIGHT side position. Do not raise or lower the mount.

Loosen the Locknut and adjust the Swivel Stop screw to the desired stopping position. Note: The locknut can be moved to the other side of the Swivel Bracket to increase the thread length.

Proceed to Step 19 to set the Soft Stop.

Repeat for the other side.

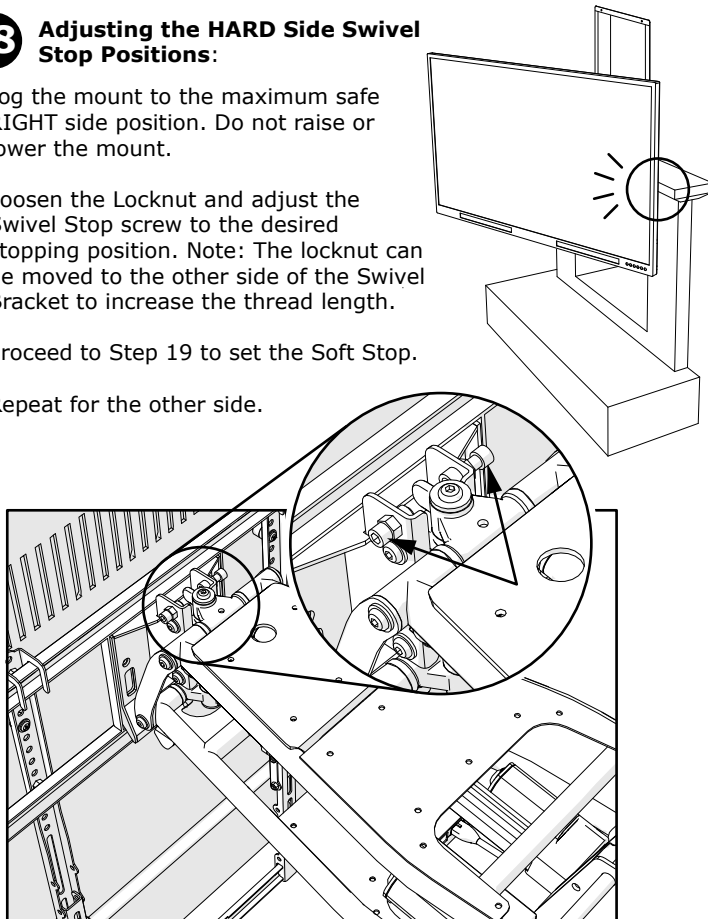

19 Adjusting the SOFT Side Swivel Stop Positions:

a. Once the RIGHT hard stop is set, jog the mount slightly inward from the Hard Stop. This will ensure the mount never hits the Hard Stop. **DO NOT JOG THE MOUNT INTO THE HARD STOP!**

b. On the Electronics Housing, quick-press the "Program" Button and verify that the Status light slow blinks.

c. On the Remote, Press the "SET" button and then within 2 seconds press the "RIGHT" button. The RIGHT Soft Stop should be set. Return to STEP 18 for other side.

d. Press the Program Button after the Soft Stops are set in order to exit Program Mode.

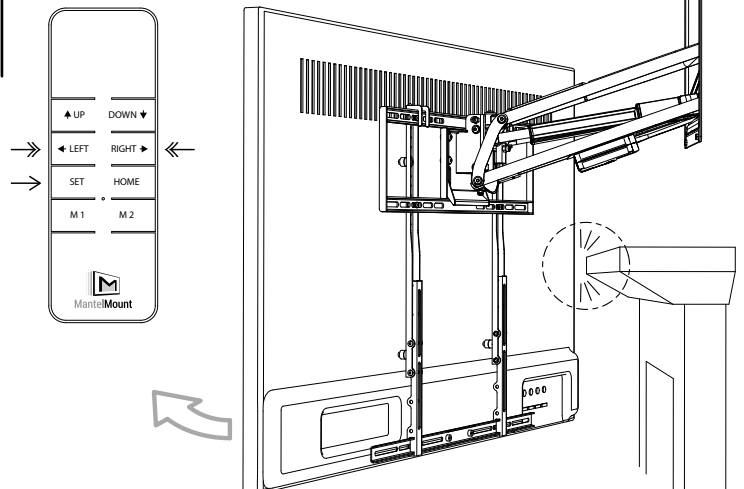

20 Adjusting the TV parallel to the wall:

In the HOME position the TV should be fairly parallel and flat to the wall vertically and horizontally.
If an adjustment is needed to flatten the TV:

Install the four silver "pushing" screws {62} into the back of the Swivel Plate {61}.
Slightly loosen the four "pulling" screws that attach the TV Frame {26} in STEP 14. Loosen more as needed.
Adjust any of the four "pushing" screws to push out the TV Frame until it is flat as desired.

Tighten the four "pulling" screws to lock the TV Frame.

Pulling Screws:
2 on each side

Pushing Screws:
2 on each side

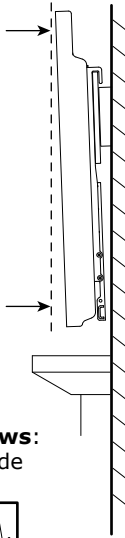
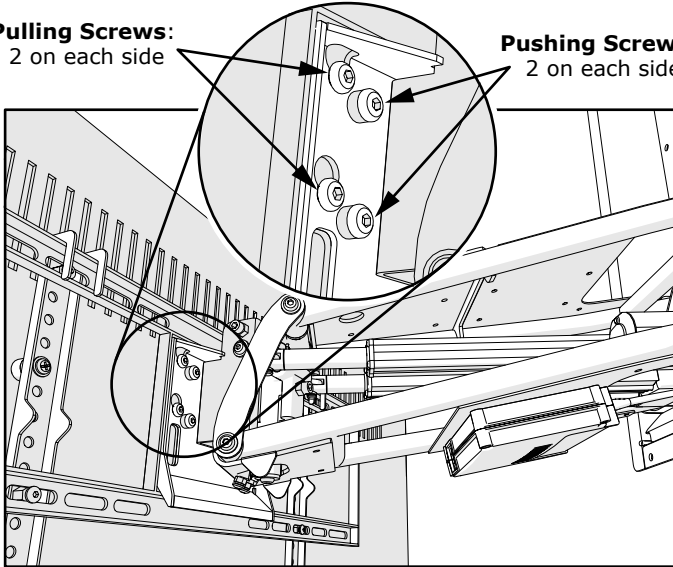

21 Setting the Memory Positions:

- Setting the Memory Positions *does not* require entering Program Mode.
- Once all of the Hard Stops and Soft Stops are set, jog the mount to the first desired viewing position.
- On the Remote, Press the "SET" button and then within 2 seconds press the "M1" button. The Memory One position should be set.
- Repeat for Memory Two position using the M2 button.

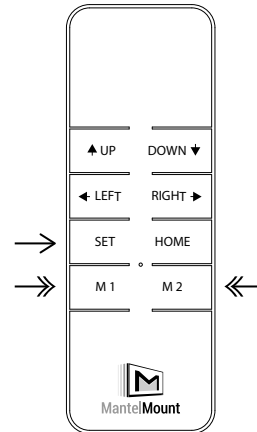

CAUTION:

The MM860 will recalibrate itself each time it is sent to the home position.

If the mount ever becomes "lost" it will move unpredictably. The mount must be manually jogged back to the home position to regain calibration.

22 Auto Raising Heat Monitor (ARHM):

This unique safety feature of the MantelMount MM860 will monitor the temperature above your fireplace at all times and raise the mount automatically if the heat behind the TV rises above 130°F (54°C).

The thermocouple sensor is located inside the electronics housing.

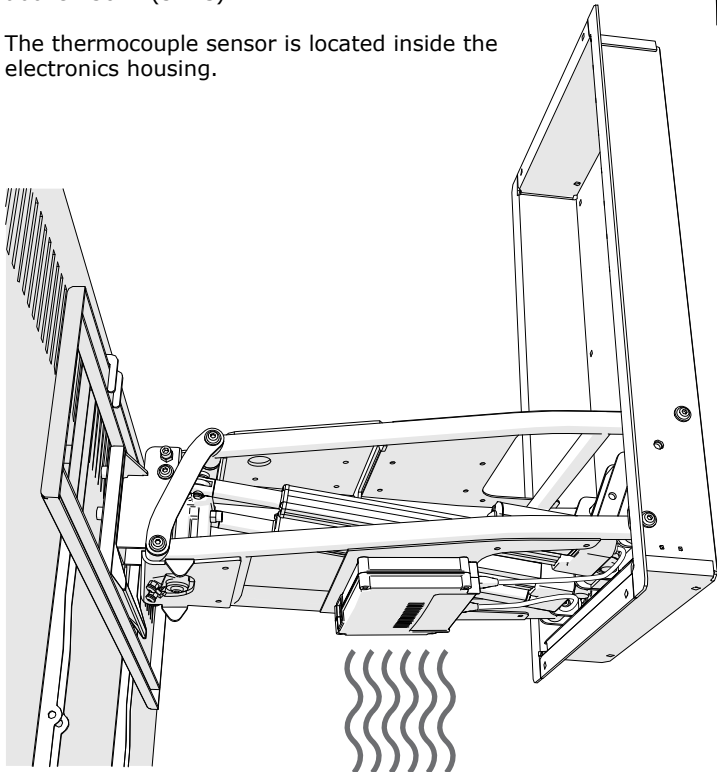

CAUTION:

Never allow children to play around, hang from, or operate MantelMount. Property damage or personal injury can occur.

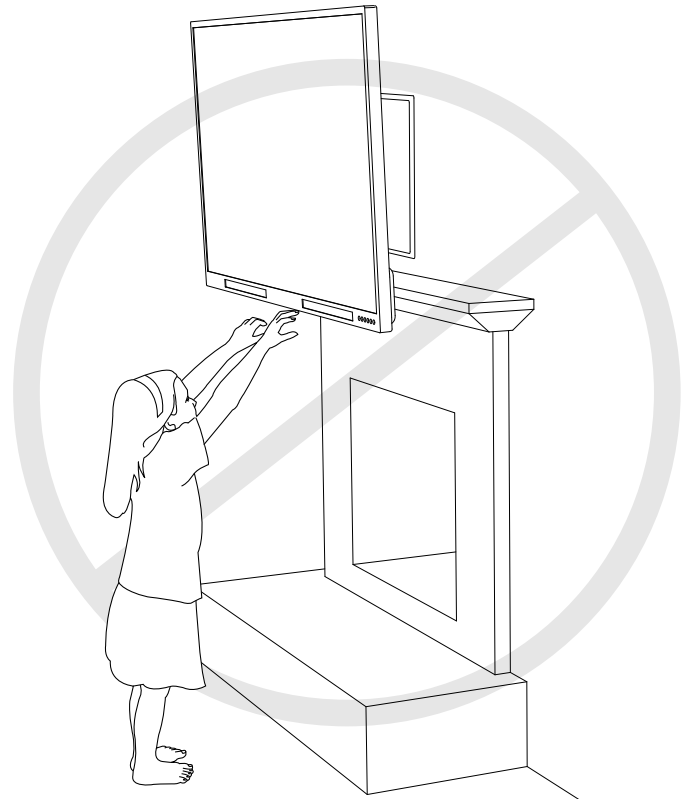

23 Attaching the TV Power Cable:

If the Auto Lowering Power Sensor (ALPS) feature is used, attach the TV Power Cable as shown. Do not plug other devices into the ALPS socket because the power will not read accurately. Loop the TV power cable down away from the pinching area of the TV Frame and the swivel portion of the mount. The cable should then be looped again toward the TV with enough extra play to allow full swivel to each side.

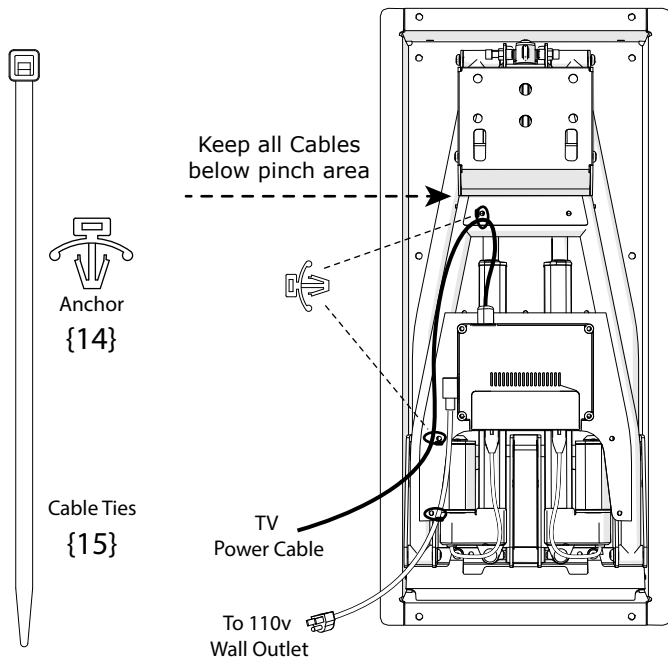

TV Power Cable using ALPS:

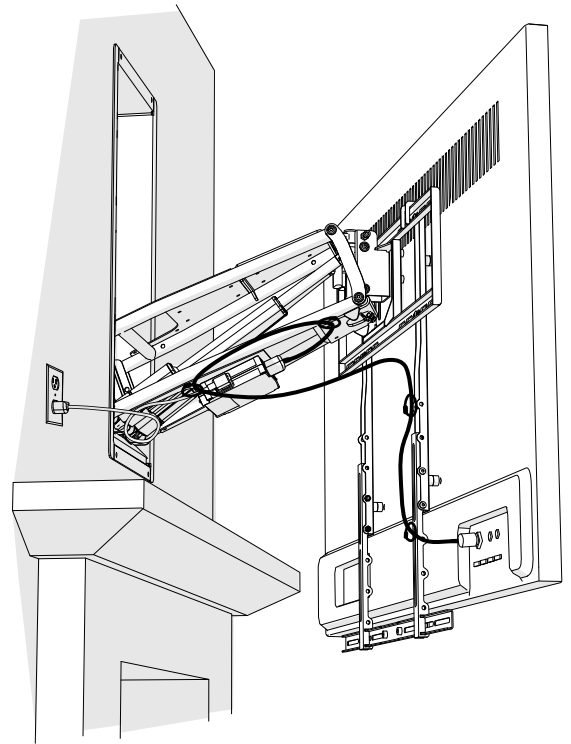

24 Reference Only: This is one possible configuration for the signal cables. Each segment of the cables has extra length so that the cables are not stressed or kinked when the mount is moved.

Ensure that cables do not get pulled or pinched between brackets when the mount is raised.

Cover to assist with cable routing:

This cover can be used to hide cables that are routed through the Housing.

Access Cover {32} requires removing two screws {18}.

CAUTION:

DO NOT block the mount from reaching the upper home position. The MM860 must recalibrate itself each time it is sent to the home position.

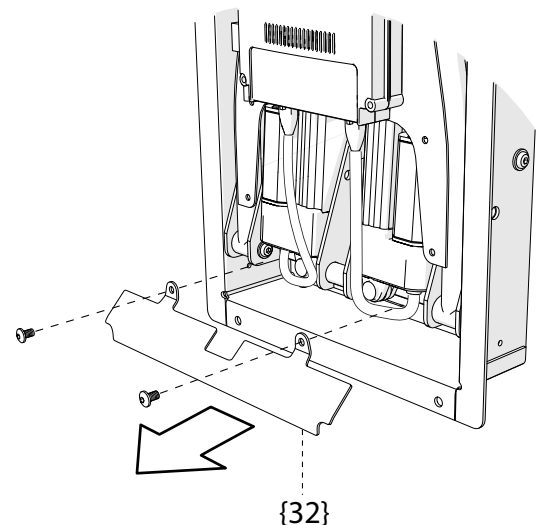
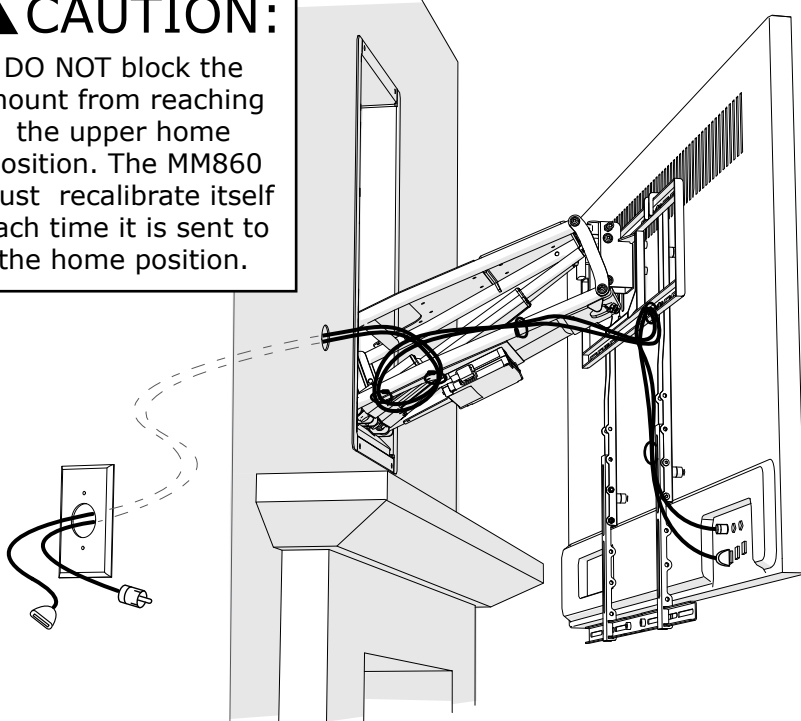

Determine how the MantelMount MM860 will be used:

MantelMount MM860 is connected to a home network (LAN):

- Home network will automatically assign an IP Address to MM860 via DHCP
MM860 can be manually assigned a Static IP Address for home automation systems (STEP 26)
- PC or laptop can manually upload the latest Firmware to the MM860 if needed
- MM860 is configured with a PC or home automation system over the network
- The *MM860 Utility* and *latest firmware* must be loaded onto the PC or Laptop before Installation

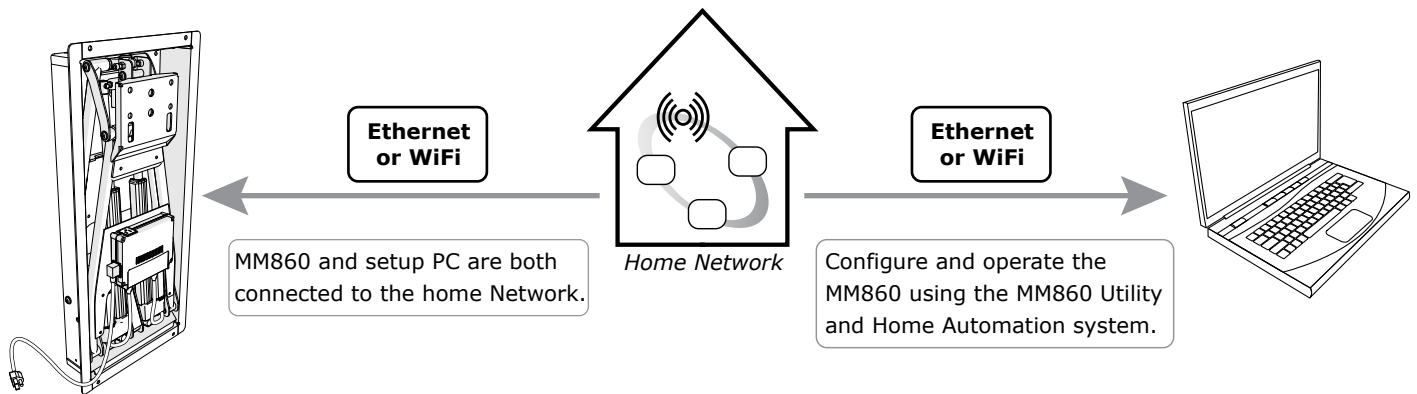

NOTE: The MM860 Wifi communication is much slower than Ethernet. If WiFi is used to operate the mount, an Ethernet connection from the computer to the Control Module is still recommended for setup and also for updating the Firmware, (if needed).

MantelMount MM860 is *not* connected to a network:

- PC (or laptop) is temporarily connected directly to the MM860 Control Module via Ethernet cable
PC must be set to the correct IP Address 192.168.150. 2 (see "Connecting with Ethernet" page 15:)
- PC or laptop can manually upload the latest Firmware to the MM860 if needed
- MM860 is configured in a web browser on a computer connected directly to the Control Module
- The *MM860 Utility* and *latest firmware* must be loaded onto the PC or Laptop before Installation

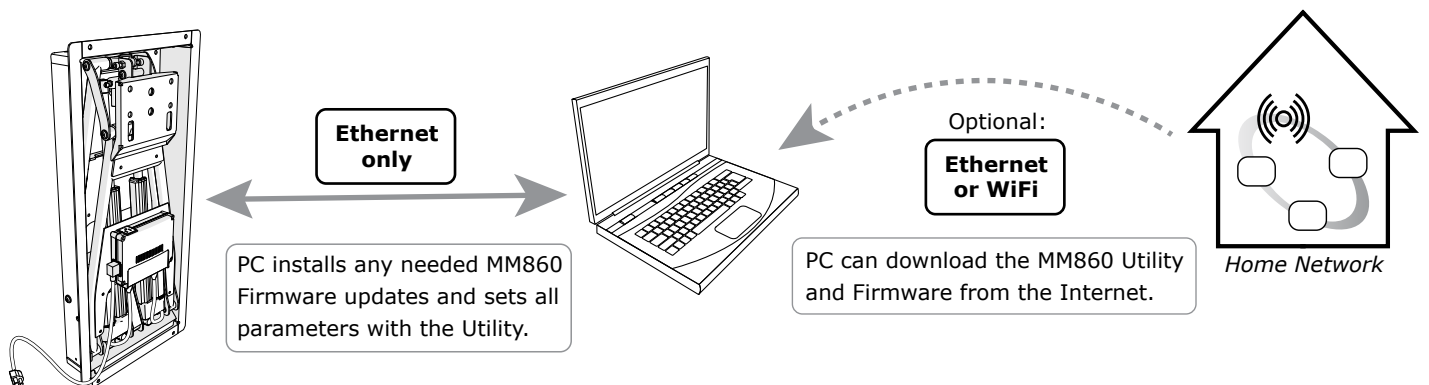

Determine how the MantelMount MM860 will be connected:

When Connecting to a Network:

- MM860 will be connected to a laptop via Ethernet for set-up, then WiFi for operation
- MM860 will be connected to a Network via Ethernet for set-up and also for operation
- MM860 will be connected to a Network via WiFi for set-up and also for operation

MantelMount MM860
also has an IRDA port
for 5-volt IR receivers
(receiver not included)

Connecting with Ethernet:

- E1** Before connecting the Ethernet cable to the Control Module, you must set your PC to the correct IP address 192.168.150.2 as follows:

To set your PC to the correct IP Address:

Go to: Settings:
Network and Internet:
Change Adapter options:
Ethernet:
Internet Protocol Version 4 (TCP/IPv4):
Properties:
enter as shown....

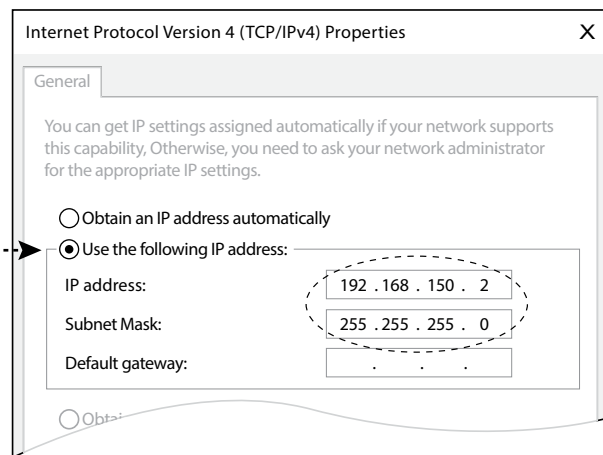

- E2** Connect the Ethernet cable to the MM860 Control Module first, and then power up the Module.

- If Ethernet is used only to set up the MM860, connect the Ethernet cable directly from the laptop to the Ethernet port in the MM860 Control Module
- If Ethernet is used for all operations, connect the Ethernet cable directly from the MM860 Control Module to the Network

- E3** Proceed to the MM860 Utility Software section (page 18) to configure the MM860.

- If Ethernet is used only to configure the MM860, use the Utility software for configuration and then return to the section "Connecting with WiFi" (page 16) to proceed with WiFi. The Ethernet cable must be disconnected from the MM860 Control Module before using WiFi.
- If Ethernet is used for all operations, do not use the "Connecting with WiFi" section.

Connecting with WiFi:

W1 Verify that the label on your Control Module is MM860 v2 (Version 2):

Older versions do not support WiFi.

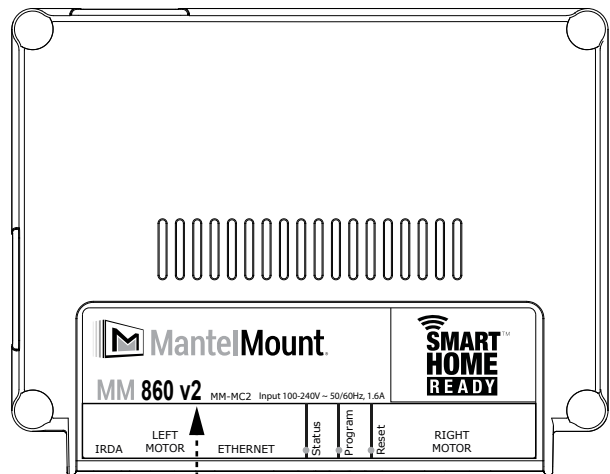

Version 2.....

W2 To begin using wifi, you must first connect to the MantelMount MM860 WiFi network that is broadcast by the Module in order to enter your specific network information. After you have entered your network information, the MM860 Module will shut down its own network and automatically connect to your network over WiFi . You can then access MM860 within the Network.

- The MM860 can only connect to a 2.4 GHz WiFi Network
- If using an extender or mesh network, for the best performance the MM860 and computer should be connected to the same node
- Before connecting, verify that the location of the MM860 has a good WiFi Signal

W3 Power On the MM860 Control Module:

In the set-up computer, locate the "MantelMount XXXXXX" in the list of available WiFi networks: (XXXXXX is a code specific to the MM860 unit).

- **DO NOT** select "Connect Automatically"
- Connect your computer to the MantelMount Network
- Wait 30 seconds for the connection to finish

W4 If the "MantelMount XXXXXX" WiFi is not broadcasting, or for other problems with connecting, the MM860 Control Module should be Reset to Factory Default settings as follows:

- On the Control Module, press and hold the "Program" button
- Use a pointy object to press the "Reset" button for one second
- Keep holding the "Program" button until the Red Light comes on
- Release the button and wait one minute for the system to reset
- The Green Light will come on when the MM860 is ready

NOTE: This will RESET all saved memory and soft stop positions, remote pairing, network information.

W5 In a web browser (Chrome preferred), enter and go to the IP address: 192.168.4.1. The following screen should appear:

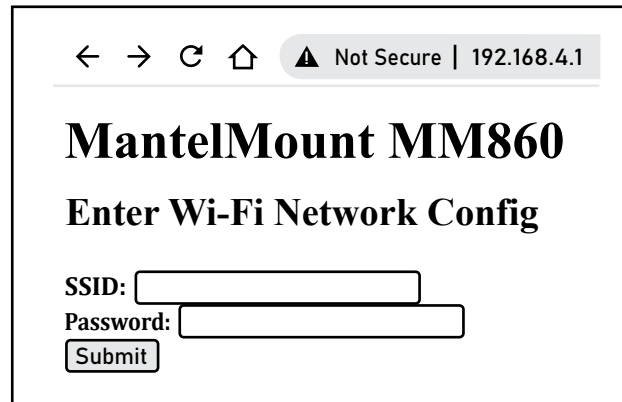

The screenshot shows a web browser window with the address bar displaying "Not Secure | 192.168.4.1". The main content area has the heading "MantelMount MM860" and a sub-heading "Enter Wi-Fi Network Config". Below this, there are two input fields: "SSID:" and "Password:". A "Submit" button is located below the "Password:" field.

W6 Click on the SSID box to show and select your desired Network for the MM860:

- Some SSID might not follow proper naming conventions. When entering the SSID Network name, DELETE ANY INSTANCES of the following characters:

Spaces commas ? " \$ [\] +

Also, DELETE the following ONLY IF they are the FIRST character:

! # ;

W7 Enter the Network Password and click Submit.

- Once connected, the MM860 will only be able to communicate over this selected network
- Browser will redirect to Success or Fail Page within 30 seconds
- If Fail, a Fail message will show up for a few seconds then redirect automatically to step W5
- If Success, a Success message will display the IP address that is assigned to the MM860

W8 Copy this IP address for future reference. In the example below the IP address is 92.168.254.15

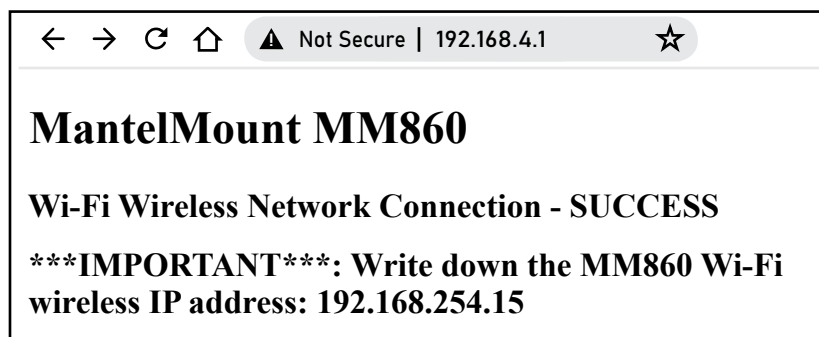

The screenshot shows a web browser window with the address bar displaying "Not Secure | 192.168.4.1" and a star icon. The main content area has the heading "MantelMount MM860" and a sub-heading "Wi-Fi Wireless Network Connection - SUCCESS". Below this, there is a message: "***IMPORTANT***: Write down the MM860 Wi-Fi wireless IP address: 192.168.254.15".

W9 The MM860 will now stop broadcasting its own MantelMount_XXXXXX network and your computer will be disconnected from MM860.

- MM860 will connect to the network selected in step W6
- Connect your Computer, via WiFi or Ethernet, to the same network as MM860 selected in Step W6
- The MM860 Utility software is now ready to use

MantelMount MM860 Utility Software Package (3 Modules):

This utility must be loaded onto a PC or laptop in order to configure the MantelMount MM860
 The MM860 Utility and MM860 Firmware are available for download at MantelMountPro.com - (Dealer)

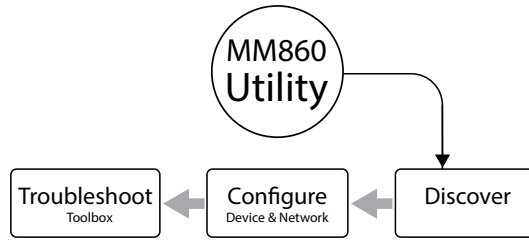

Start Here

Module 1: Auto-Discover

This tool will automatically identify each MM860 unit on a network by their IP and MAC addresses.

Module 1 provides access to Module 2 and Module 3

MM860 Default Settings:

IP address: 192.168.150.111

MAC Address: d8 : 3a : f5 : xx : xx : xx

Unique to each MM860
Used in the Host Name

Host Name: MantelMount_xxxxxx

Module 2: Configuration (Device page, Network Page)

This web page is hosted on the MM860 unit. It contains all network information, it is used to update firmware, and it accesses basic MM860 parameters.

Module 3: Toolbox

This tool gives access to more detailed MM860 parameters for fine tuning and trouble-shooting.

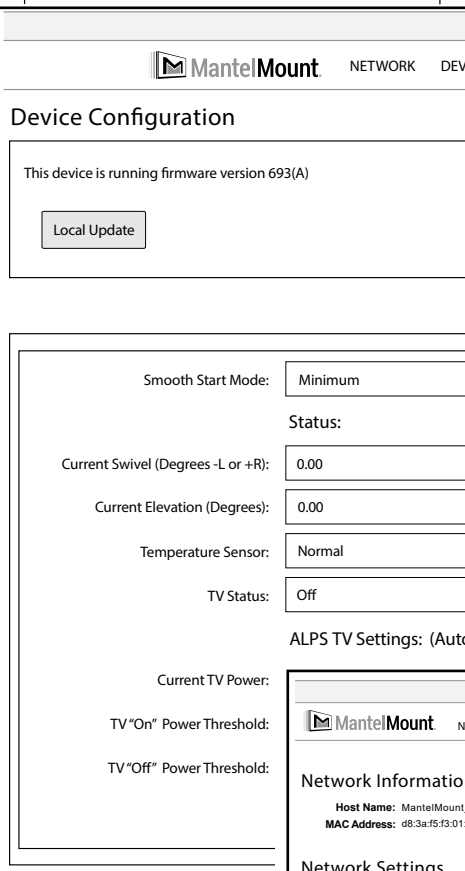
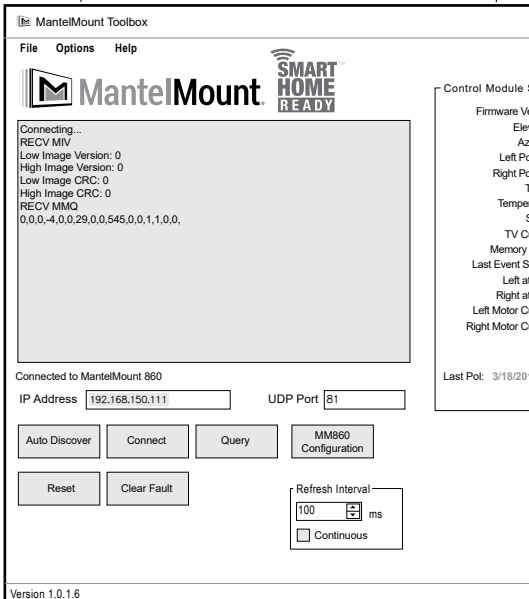
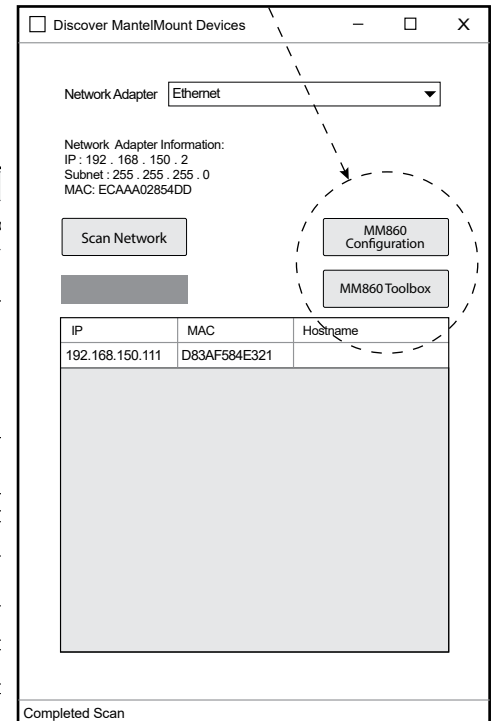

ALPS TV Settings: (Auto Lowering Power Sensing):

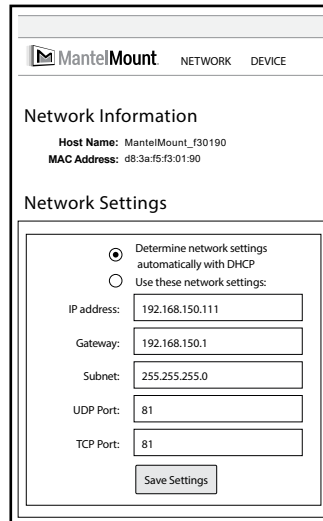

25 Launch the MM860 Utility:

Module 1 will open:
"Discover MantelMount Devices".

Scans the Network to find all MantelMount products.
If the MM860 is not on a Network, Ethernet will connect with the MM860 only if the PC is set to the correct IP Address: 192.168.150. 2

Progress Bar

Module 1: Auto-Discovery

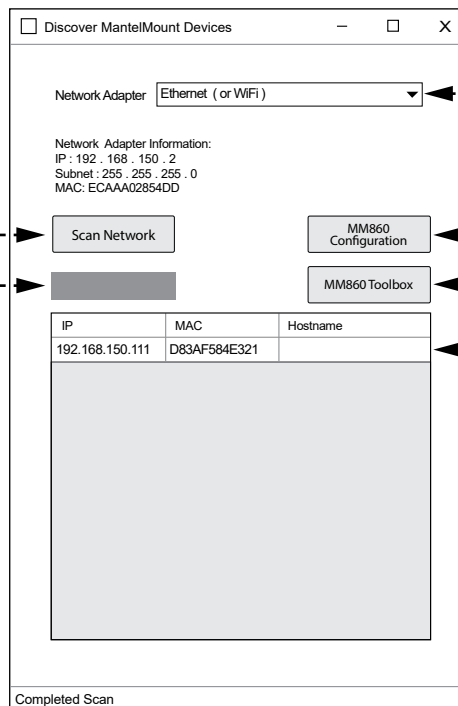

Select Ethernet or WiFi based on how the MM860 is connected to the Network.

Opens the Configuration Module 2

Opens the Toolbox Module 3

After a Scan, this will display only MantelMount products. Select the correct MM860 here.

HOME AUTOMATION SYSTEMS:

After the IP Address for the MM860 is assigned, you can use the MM860 Driver for your Automation System to set up the MM860.

Drivers are located at MantelMountPro.com (Dealers)

26 Open the Configuration Module:

Use the "Device" Page to adjust the MM860 parameters if needed. These settings are stored onboard the MM860.

Module 2: MM860 Configuration (Device Page)

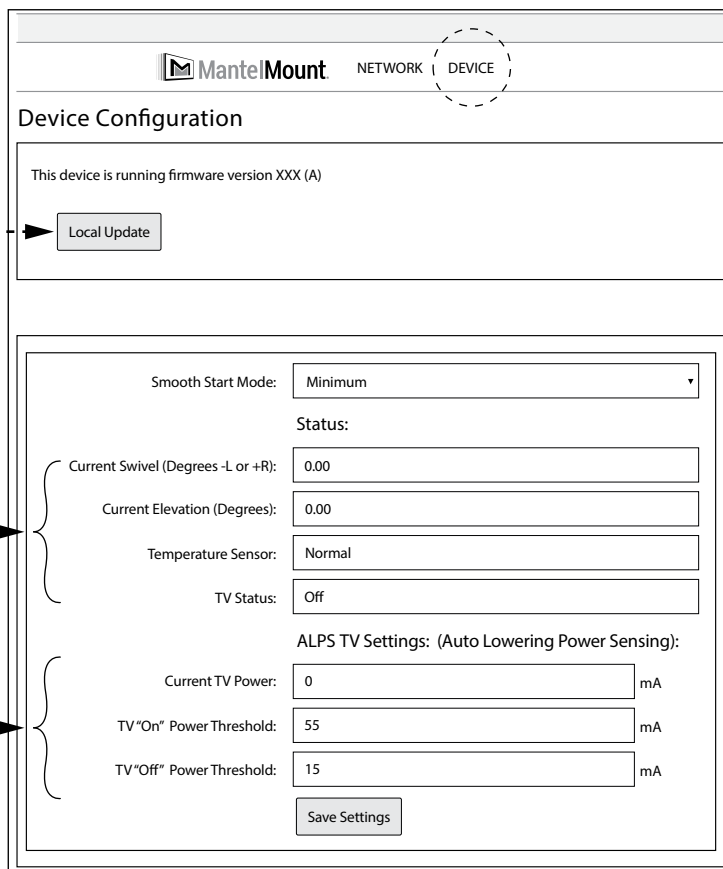

Firmware Update (Manual)

Status

ALPS

Module 2: (Network Page)

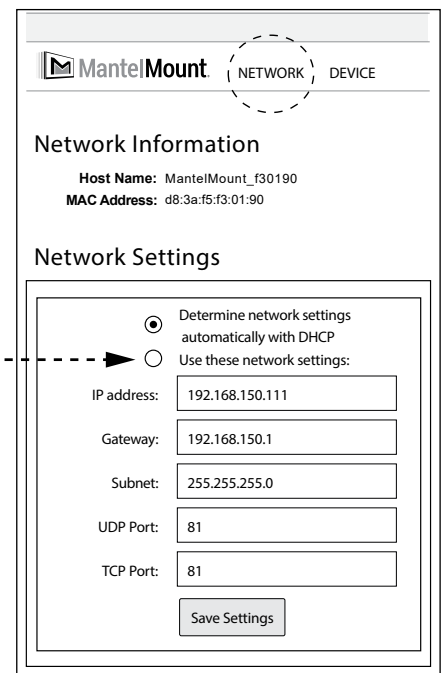

Use the "Network" page to assign a specific Static IP Address for Home Automation systems.

Static IP is highly recommended for WiFi connections.

27 Configuration Module (continued):

Updating Firmware and adjusting ALPS (if needed):

Firmware Update (Local):

MM860 stores two copies of Firmware onboard, Versions A and B. One version is running while the other version is available to update. Download both A and B versions of the latest Firmware onto the installation PC before starting.

If the MM860 is running Version A then upload Version B. "Local Update" will ask for the location on the PC for the update, but it will not accept the same Version that it is currently running.

Using WiFi:

If the 3-digit version number does not show, reload the page.

Smooth Start Modes:

Uses ramped speeds as the mount starts moving downward.

Auto Lowering Power Sensing (ALPS): (when enabled)

The MM860 monitors the power running through the cord of the TV. When the TV is turned on, the MM860 will detect increased power and automatically lower to Memory 1 position. When the TV is turned off, the MM860 will wait up to 10 seconds to be sure, then raise the mount.

If the ALPS feature is false triggering, verify what the TV is actually using during on and off events and fine tune the set points that trigger the ALPS feature. The ALPS settings must be within the TV operating range.

TV Power is displayed in real-time with Ethernet connection, but WiFi requires page refresh each time the TV is turned on or off.

A good rule is to be 20% inside of each end of the operating range. Example: TV ON = 80(mA), TV OFF = 5(mA), total range = 75(mA) $75 \times 0.2 = 15(mA)$. Thresholds would be 65(mA) and 20(mA).

Module 2: MM860 Configuration (Device Page)

28 Toolbox Module:

This module is only needed for troubleshooting or verifying that the MM860 is operating correctly.

Module 3: MM860 Toolbox

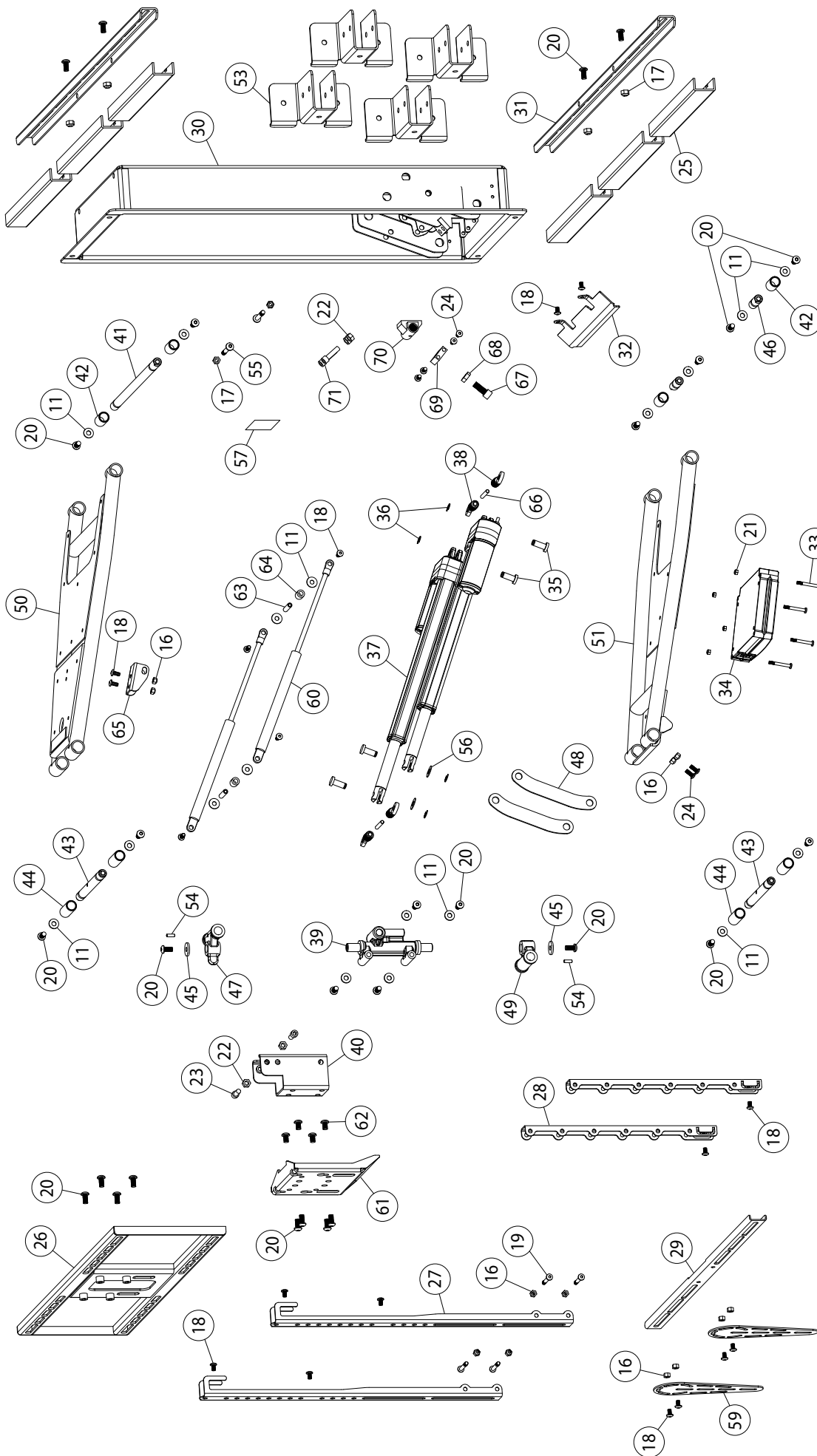

INSTRUCTION MANUAL

73

TEMPLATE

72

Additional Installation Parts

74

01

02

03

04

05

06

07

08

09

10

11

12

13

14

15

52

58

ITEM NO.	PART NUMBER	DESCRIPTION	QTY.
39	21060	Swivel	1
40	21073	Swivel Bracket	1
41	21033	Axle	1
42	21119	Bushing	4
43	21037	Axle	2
44	21121	Bushing	4
45	21092	Washer M8 x 3 x 24	2
46	21035	Axle	2
47	21054	Top Pivot	1
48	21041	Connector Brace	2
49	21063	Bottom Pivot	1
50	21018	Upper Arm, Welded	1
51	21081	Lower Arm, Welded	1
52	21228	Power Cable, NEMA, U.S.	1
53	15023	Stud Bracket	4
54	21163	Set Screw M5 x 15	2
55	21185	Round Screw M8 x 50	2
56	21147	Washer M10	2
57	21211	Warning Sticker	1
58	21200	Remote Control	1
59	15010	Soundbar Wing	2
60	21240	Gas Spring	2
61	21074	Swivel Adjustment Plate	1
62	21182	Round Screw, Silver, M8 x 12	4
63	21223	Mounting Rod	2
64	21225	Spacer	2
65	21237	Upper Bracket	1
66	21171	Anchor Alignment Pin	2
67	21177	Socket Cap Screw M10 x 25	1
68	21149	Nut M10	1
69	21076	Lower Adjustment Block	1
70	21048	Sliding Anchor Pivot	1
71	21179	Socket Cap Screw M8 x 30	2
72	21190	Cardboard Template 735 x 335mm	1
73	MM860M	Instruction Manual	1

ITEM NO.	PART NUMBER	DESCRIPTION	QTY.
1	12189	M5 x 12	4
2	12190	M5 x 30	4
3	12191	M5 x 40	4
4	12193	M6 x 16	4
5	12194	M6 x 30	4
6	12195	M6 x 40	4
7	12197	M8 x 15	4
8	12198	M8 x 25	4
9	12199	M8 x 45	4
10	12166	Washer M6	8
11	14126	Washer M8 x 2	26
12	12122	Spacer	12
13	14137	Lag Bolt M8 x 60	6
14	14110	Cable Tie Anchor	6
15	12162	Cable Tie	12
16	12183	Locknut M6	12
17	12187	Locknut M8	6
18	12178	Round Screw M6 x 12	18
19	12255	Round Screw M6 x 40	4
20	12176	Round Screw M8 x 16	28
21	21191	Locknut M5	4
22	12186	Nut M8	4
23	21088	Socket Cap Screw M8 x 25	2
24	21178	Round Screw M6 x 15	6
25	21140	Wall Cover	6
26	21050	TV Frame, Welded	1
27	14038	Vertical Brace	2
28	14056	Brace Extender	2
29	14060	TV Horizontal Brace	1
30	21015	Recess Frame, Welded	1
31	21039	Horizontal Brace	2
32	21160	Access Cover	1
33	21188	Round Screw M5 x 40	4
34	21230	Command Module	1
35	21170	Pivot Shaft	4
36	21168	Clip	4
37	21151	Actuator	2
38	21165	Anchor, Actuator	4

Customer Service:
 (800)-897-9755
 www.MantelMount.com

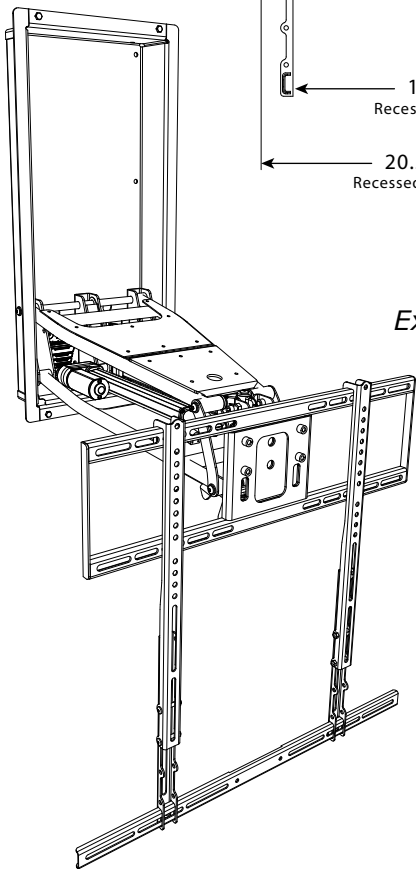
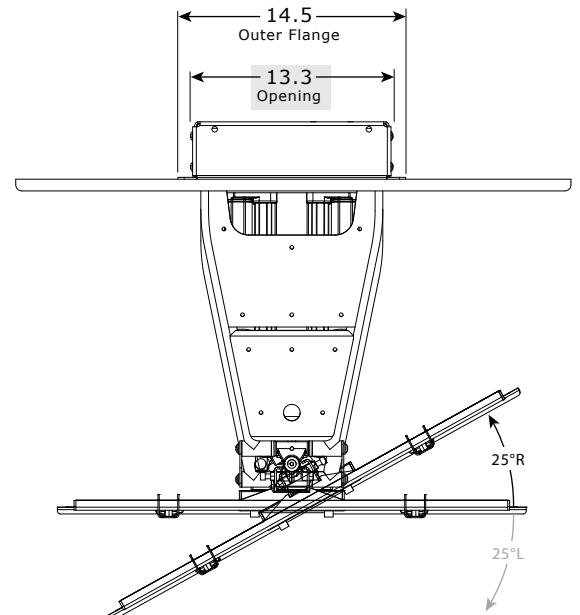
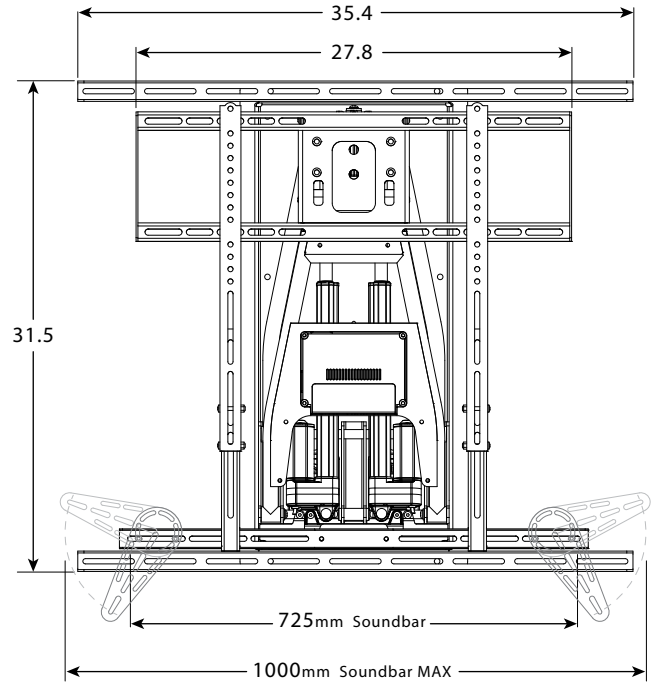
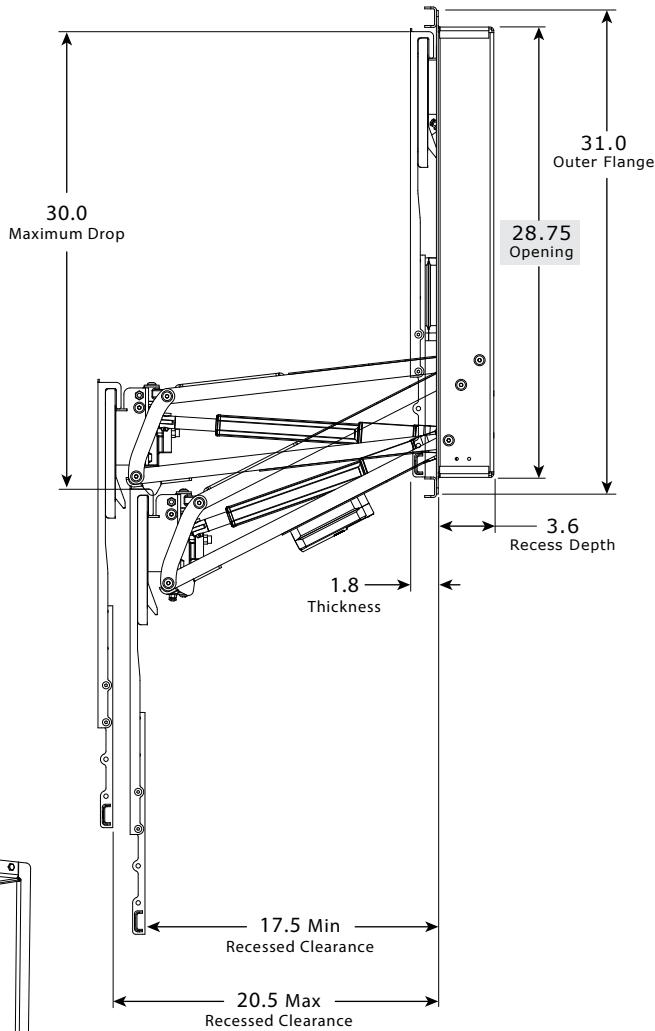

Exclusive MantelMount Features!

Auto-Lowering Power Sensor (ALPS)
 Monitors when the TV is turned on or off and operates MantelMount automatically
Patent Pending

Auto-Raising Heat Monitor (ARHM)
 Monitors the temperature and raises the TV automatically if the temp. behind the TV is above 130°F
Patent Pending

Multi-Axis Control Hub (MACH)
 One unit with six degrees of articulation that controls both the vertical and horizontal movement
Patent Pending

Full Manufacturer Warranty:
 MantelMount will replace or repair any product or part that proves defective due to improper workmanship or material during the warranty period.
 Visit www.MantelMount.com for details.

This Installation Manual is available for download as a PDF document at www.MantelMount.com. The PDF version can be used to see larger images or to zoom in for much greater detail.