



INSTALLATION MANUAL

ESA-70V2CH-150W

ESA-70V2CH-300W

ESA-70V2CH-500W

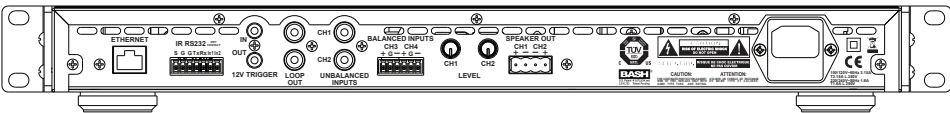
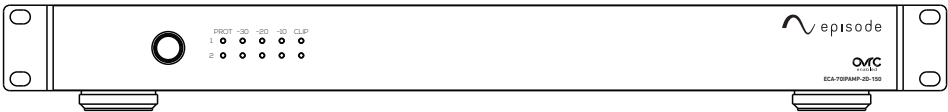

REAL. LIFE. SOUND.

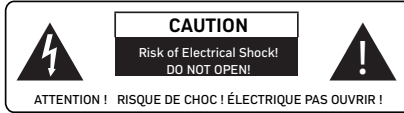

	<p>The lightning flash with arrowhead symbol, within an equilateral triangle, is intended to alert the user to the presence of uninsulated dangerous voltage within the product's enclosure that may be of sufficient magnitude to constitute a risk of electric shock to persons.</p>
	<p>The exclamation point within an equilateral triangle is intended to alert the user to the presence of important operating and maintenance (servicing) instructions in the literature accompanying the appliance.</p>

IMPORTANT SAFETY INSTRUCTIONS

WARNING: To reduce the risk of fire or electric shock, do not expose this apparatus to rain or moisture.

1. Read these instructions.
2. Keep these instructions.
3. Heed all warnings.
4. Follow all instructions.
5. Do not use this apparatus near water.
6. Clean only with dry cloth.
7. Do not block any ventilation openings. Install in accordance with the manufacturer's instructions.
8. Do not install near any heat sources such as radiators, heat registers, stoves, or other apparatus (including amplifiers) that produce heat.
9. Do not defeat the safety purpose of the polarized or grounding-type plug. A polarized plug has two blades with one wider than the other. A grounding-type plug has two blades and a third grounding prong. The wide blade or the third prong are provided for your safety. If the provided plug does not fit into your outlet, consult an electrician for replacement of the obsolete outlet.
10. Protect the power cord from being walked on or pinched, particularly at plugs, convenience receptacles, and the point where they exit from the apparatus.
11. Only use attachments/accessories specified by the manufacturer.
12.  Use only with the cart, stand, tripod, bracket, or table specified by the manufacturer, or sold with the apparatus. When a cart is used, use caution when moving the cart/apparatus combination to avoid injury from tip-over.
13. Unplug this apparatus during lightning storms or when unused for long periods of time. Refer all servicing to qualified service personnel. Servicing is required when the apparatus has been damaged in any way, such as power-supply cord or plug is damaged, liquid has been spilled or objects have fallen into the apparatus, the apparatus has been exposed to rain or moisture, does not operate normally, or has been dropped.
14. This product employs a Class I (or grounded) construction and shall be connected to a mains socket outlet with a protective earthed (or ground) connection.
15. DO NOT EXPOSE THIS EQUIPMENT TO DRIPPING OR SPLASHING AND ENSURE THAT NO OBJECTS FILLED WITH LIQUIDS, SUCH AS VASES, ARE PLACED ON THE EQUIPMENT.
16. TO COMPLETELY DISCONNECT THIS EQUIPMENT FROM THE AC MAINS, DISCONNECT THE POWER SUPPLY CORD PLUG FROM THE AC RECEPTACLE.
17. THE MAIN PLUG OF THE POWER SUPPLY CORD SHALL REMAIN READILY OPERABLE.
18. **CAUTION:** TO REDUCE THE RISK OF ELECTRICAL SHOCK, DO NOT REMOVE COVER. NO USER SERVICEABLE PARTS INSIDE. REFER SERVICING TO QUALIFIED SERVICE PERSONNEL.

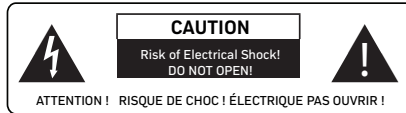

	Le flash de foudre avec le symbole de pointe de flèche, dans un triangle équilatéral, est prévu pour alerter l'utilisateur à la présence de la tension dangereuse non isolée dans la clôture du produit qui peut être de la grandeur suffisante pour constituer un risque de décharge électrique aux personnes..
	Le point d'exclamation dans un triangle équilatéral est prévu pour alerter l'utilisateur à la présence des instructions importantes de fonctionnement et d'entretien (entretien) dans la littérature accompagnant l'appareil.

CONSIGNES DE SÉCURITÉ IMPORTANTES

Avertissement: Pour réduire le risque d'incendie ou un choc électrique, ne pas exposer cet appareil à la pluie ou à l'humidité.

1. Lisez ces instructions.
2. Conservez ces instructions.
3. Respectez tous les avertissements.
4. Suivez toutes les instructions.
5. Ne pas utiliser cet appareil près de l'eau.
6. Nettoyer avec un chiffon sec.
7. Ne pas bloquer les ouvertures de ventilation . Installer conformément aux instructions du fabricant.
8. Ne pas installer près de sources de chaleur telles que des radiateurs , registres de chaleur, poêles ou autres appareils (incluant les amplificateurs) qui produisent de la chaleur.
9. Ne pas contourner le dispositif de sécurité de la fiche polarisée ou de mise à la terre . Une fiche polarisée possède deux lames dont une plus large que l'autre . Une fiche de terre a deux lames et une troisième broche de mise à la terre . La lame large ou la troisième broche sont fournies pour votre sécurité . Si la fiche fournie ne rentre pas dans votre prise, consultez un électricien pour le remplacement de la prise obsolète.
10. Protégez le cordon d'alimentation ne soit piétiné ou pincé, en particulier au niveau des fiches , des prises de courant et le point de sortie de l'appareil.
11. N'utilisez que des fixations / accessoires spécifiés par le fabricant.
12.  Utilisez uniquement avec le chariot, le trépied, le support ou la table spécifiés par le fabricant, ou vendu avec l'appareil. Quand un chariot est utilisé, faites attention en déplaçant l'ensemble chariot/appareil pour éviter les blessures en cas de renversement.
13. Débranchez cet appareil pendant les orages ou lorsqu'il n'est pas utilisé pendant de longues périodes de temps. Refer à un technicien qualifié personnel . Une réparation est nécessaire lorsque l'appareil a été endommagé de quelque façon que ce cordon d' alimentation ou la prise est endommagé , du liquide a été renversé ou des objets sont tombés dans l'appareil, l'appareil a été exposé à la pluie ou à l'humidité , ne fonctionne pas normalement , ou s'il est tombé .
14. Ce produit utilise une classe I (ou la terre) construction et doit être raccordé à une prise de courant mise à la terre avec une protection (ou masse) .
15. NE PAS EXPOSER CET APPAREIL À éclaboussures et s'assurer qu'aucun OBJET REMPLI DE LIQUIDE , TEL QU'UN VASE , sont placés sur le MATÉRIEL .
16. Pour déconnecter totalement cet appareil du secteur, débranchez la CORDON D'ALIMENTATION fiche de la prise secteur.
17. LA PRISE PRINCIPALE DU CORDON D'ALIMENTATION doit rester facilement accessible .
18. **ATTENTION:** POUR RÉDUIRE LE RISQUE DE CHOC ÉLECTRIQUE, NE PAS RETIRER. NO réparable par l'utilisateur pièces à l'intérieur. CONFIER L'ENTRETIEN DE PERSONNEL QUALIFIÉ .

INTRODUCTION

Thank you for purchasing Episode® amplifiers. To complete installation, follow these instructions. Visit our website for design recommendations and speaker calculators.

The ESA-70V2CH 2-channel, 70-volt digital power amplifier series is designed for applications requiring two channel stereo audio, or two mono zones of audio with different sources or levels.

IP CONTROL

This amplifier is capable of IP control. The default IP address is **192.168.100.115**. The default username and password is “**admin**”. For more information on setup using the WebGUI, refer to the Configuration Utility Manual available on the product support tab.

CONTENTS

1x ESA-70V2CH-150/300/500W Amplifier	4x Removable Feet
1x Detachable 6ft IEC Power Cable	1x Installation Manual
2x Mounting Ears for Amplifier	

TOOLS

- 2.0mm slotted Flathead Screwdriver
- Wire Strippers

SPEAKER RECOMMENDATION

The ESA-70V2CH amplifier is only meant to be used with 70V loudspeakers. Use any combination of speakers as long as the sum of the wattage does not exceed the rated wattage of the speaker output.



FRONT PANEL

ESA-70V2CH-150W, 300W



ESA-70V2CH-500W

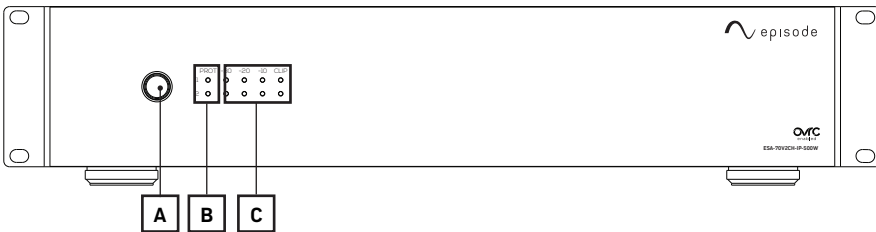

A. Power Switch with LED Indicator

Momentary switch for manual control of standby power mode.

BLUE – On.

RED – Standby.

B. Protection LED

Indicates whether a channel is operating correctly or is in protection.

BLUE – Normal.

RED – Protection. (Indicates an issue with installation or setup)

C. Output Level Meter

Level meter flashes green to indicate current output level for each channel. LEDs will illuminate green accordingly as levels ranging from -30dB to -10dB are played. If a channel is clipping, the red CLIP LED will illuminate during periods of clipping (turn down input gain immediately if clipping occurs).

REAR PANEL

ESA-70V2CH-150W, 300W

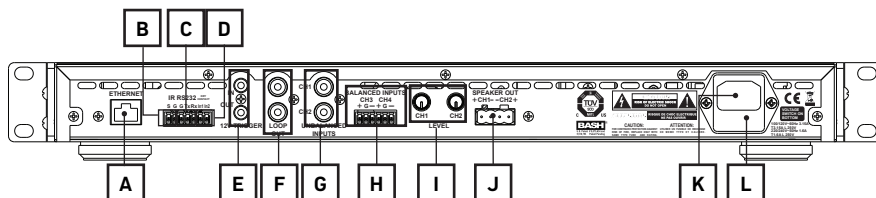

ESA-70V2CH-500W

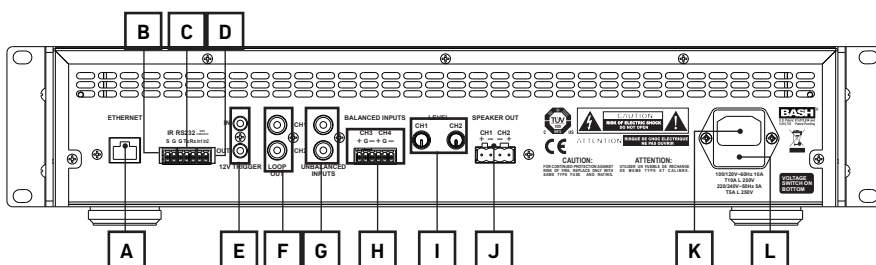

A. Ethernet Port

RJ45 port for connecting an Ethernet Cat5e/6 cable for IP control of the amplifier.

B. IR

Control the amplifier via IR from your control system. This input accepts a mono connector – Signal and GND only, no 12V signal supplied.

C. RS-232

To communicate with a control system or PC for serial control of the amplifier.

D. Dry Contact

Use dry contact to toggle amp ON/OFF, or mute/unmute. Setup through web GUI.

E. 12 Volt Trigger IN and OUT

When 4.5-15 Volts DC are applied to 12V IN, amplifier will turn on. When voltage is dropped, amplifier turns back off. 12V OUT allows other equipment to be controlled from the same 12V signal.

F. Loop Outputs 1 & 2

Unbalanced mono RCA connections for sending audio to other devices.

G. Unbalanced Inputs 1 & 2

Unbalanced mono RCA input connections for connection of sources.

H. Balanced Inputs 3 & 4

Set-screw connections for sources with balanced output.

I. Output Level Adjustment Dials

Digital encoder to adjust output volume levels. Turn clockwise to send volume increase commands and counter-clockwise to send volume decrease commands.



J. Speaker Output Connections

Set-screw connections for speaker output channels 1 & 2. Accommodates 22-14AWG wire.

K. IEC Power Cord

Detachable power for amplifier.

L. AC Fuse

Replaceable main power fuse.

BOTTOM PANEL

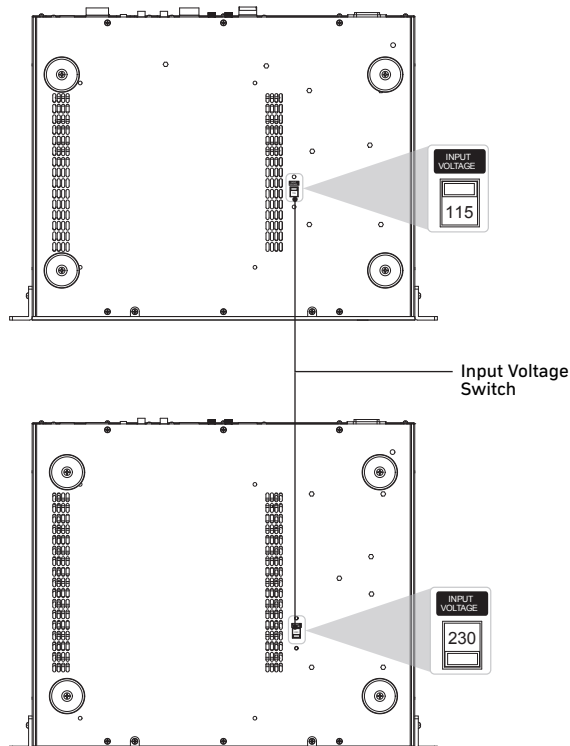

Input Voltage Switch

Set the input voltage for 115V or 230VAC operation based on the voltage available.

NOTE: The ESA-70V2CH includes an IEC cable meant for use with a NEMA 5-15 receptacle supplying 115V AC power. For countries utilizing 230V AC power, the cable can be swapped to the correct cable for that region. When using the 230V AC input voltage setting, change the fuse in the amplifier from the included to a fuse rated for 230V AC. See the Specifications on page14 for the correct fuse type for each model. Using the wrong fuse could result in blown fuses or damage to the amplifier, which is not covered by the warranty.

POSITIONING THE AMPLIFIER

Placing the amplifier can have a large impact on performance and longevity. Please take the following guidelines into consideration.

Shelf Mounting

- Be sure that the unit is in a well-ventilated area that provides adequate cooling.
- Do not block the cooling vents located on both sides of the unit.
- Do not place the unit on carpeting or any similar material.
- Do not install the unit near a source of heat, or in an extremely humid or wet location.
- If your installation lacks good air flow (such as solid cabinet doors or wall-mounted racks), it may be necessary to create ventilation to allow outside air into the space.
- A minimum of 2" of free space should be allowed above and below the unit for optimum performance.

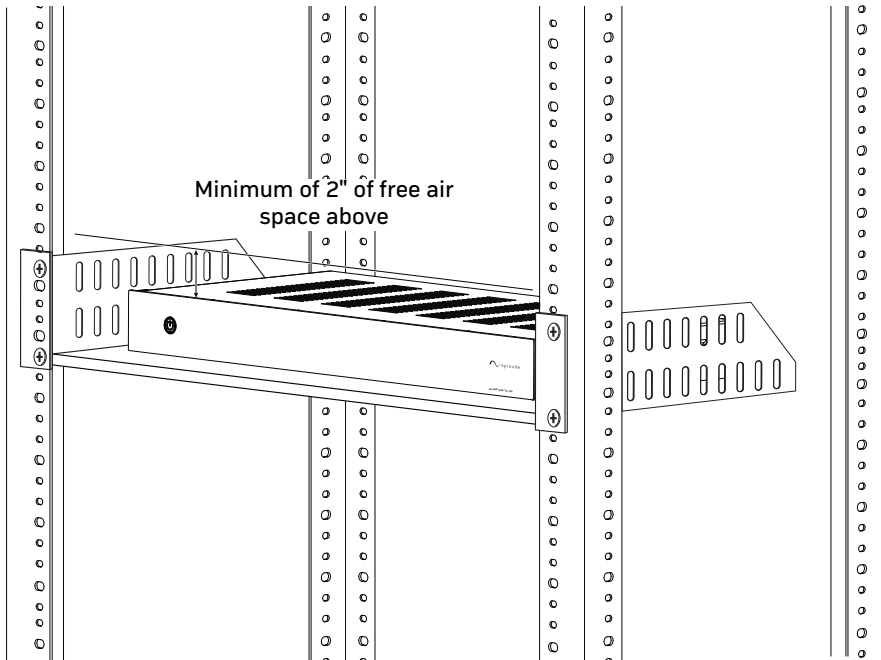



Rack Mounting

- Rack mount ears may be removed if not needed.
- Bottom feet on the amplifier chassis may be removed if necessary.

NOTE: Do not place the screws back into the chassis. Without the feet, the length of the screw may touch internal components and affect the performance of the amplifier.

- Attach the included rack-mount ears to the front sides of the amplifier chassis.
- Securely mount the amplifier into an equipment rack. The amplifier will occupy 1U of rack space.
- Ensure that the unit is in a well-ventilated area that provides adequate cooling.
- Free air space is required above the amplifier and below the amplifier. The recommended distance is 1U to 2U, 1.75" to 3.5" being sure to avoid blocking any vents on the unit's chassis.

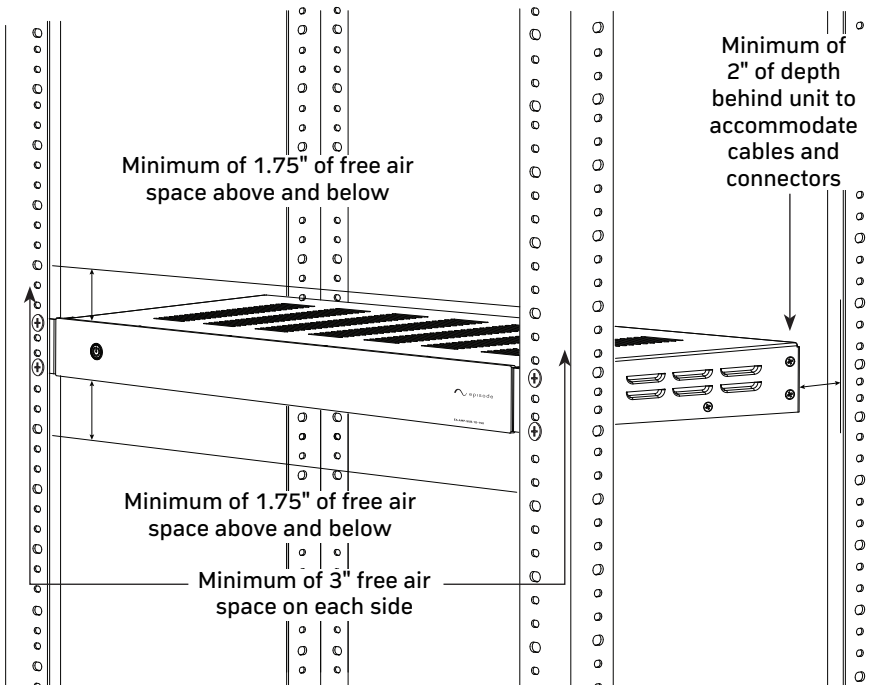
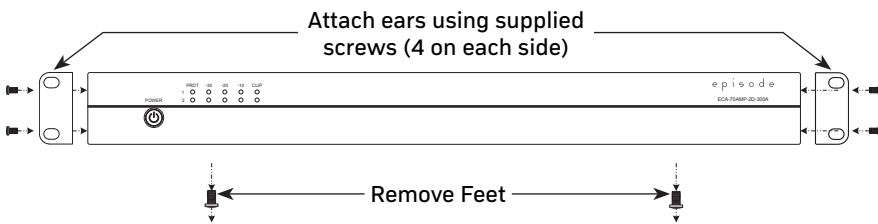

SOURCE CONNECTIONS

Balanced Input

Use the BALANCED INPUT to connect balanced or unbalanced cables to the amplifier.

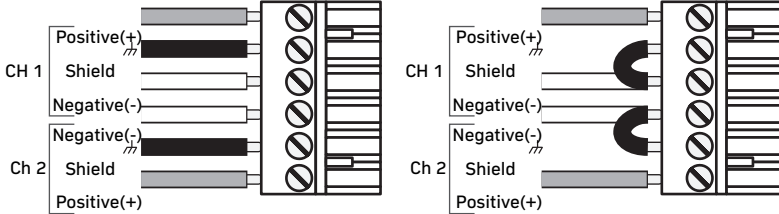

Note jumper between Shield and Negative(-). Create the adapter shown above if there is no balanced source and more unbalanced source connections to the amp are needed.

Unbalanced Connections

Use standard RCA cables to connect sources using the UNBALANCED LINE IN input. Connect sources through the applicable mono input. Use the LOOP OUT ports to connect more amplifiers or equipment.

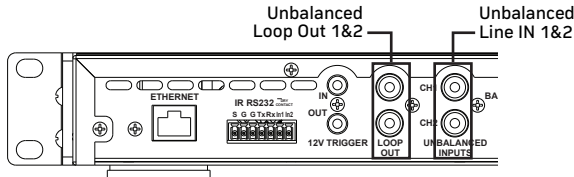

Using Fixed Output Loop Out

The LOOP OUT connections on the amplifier may be used to send audio signals to other equipment, or to the other channel of the amplifier. This connection sends audio signals out from the UNBALANCED INPUT of the channel.

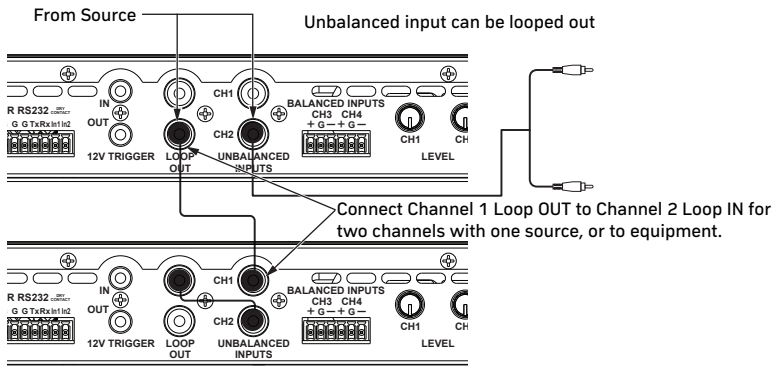



SPEAKER CONNECTIONS

Use 14 or 16 gauge stranded two-conductor speaker wire. Connect the appropriate conductor to each screw terminal, observing correct polarity.

CONTROL CONNECTIONS

IR

Connect a control system to this input via a mono connector (Signal and GND only, no 12V signal supplied) to control the amplifier via IR from your control system. See page 6 for IR port location.

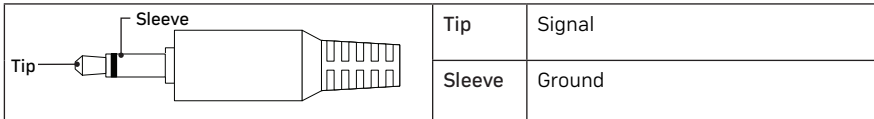

RS-232

Connect using the correct pin configuration for the control system in use. Configuration for control system serial ports can vary. Refer to the documentation for the system in use to ensure proper connection and configuration.

The ESA-70V2CH-IP receives control data on pin 2 (Rx D – Data Receive) and transmits control data on pin 3 (Tx D-Data Transmit). See the diagram below for details.

Pin	Function
2	RxD (Data Receive)
3	TxD (Data Transmit)
5	Ground/Common

DB9 Female Connector

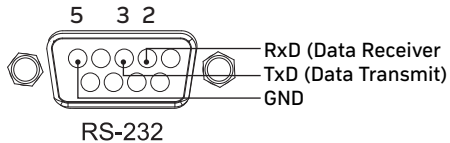

IP

1. Connect a Cat5e/6 network cable from the Ethernet port of the amplifier to a network with DHCP enabled (DHCP server is usually in the router).
2. Use an IP scanner to detect the IP address assigned to the amplifier.
3. Enter the IP address into a web browser to access the user interface and change settings.

Default Login Information:

- Username: admin
- Password: admin

The following settings can be changed in the web GUI:

- System Status
- Input/Output configuration
- Audio Routing configuration
- Power On settings
- Network IP and Clock settings
- Password settings

AMPLIFIER POWER CONTROL

Front Panel Power Button

When the amplifier is powered ON, the power button will illuminate solid blue. When it is in STAND-BY, the power button will be red.

Resetting the Amplifier

Press and hold the power button for 10 seconds once the receiver is powered on for a "soft" reset. This will reset login information.

Press and hold for 20 seconds to initiate a factory reset. The front panel lights will flash indicating the reset is in progress. This will reset all settings including DSP, channel levels and input names.

12 Volt Trigger

The ESA-70V2CH-IP line of amplifiers are equipped with 12V DC trigger inputs and outputs for trigger control and daisy chain control of more than one amplifier.

To utilize the 12V DC trigger function, attach a mono mini cable between the 12V trigger output of the controlling device and the 12V DC TRIGGER IN port of the amplifier. Connect other devices to the OUT port on the amplifier using a mono-mini cable.

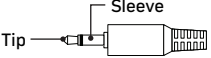
		Cable	3.5mm Mono-mini
		Tip	4.5-15V DC (constant during use)
		Sleeve	Ground/Common

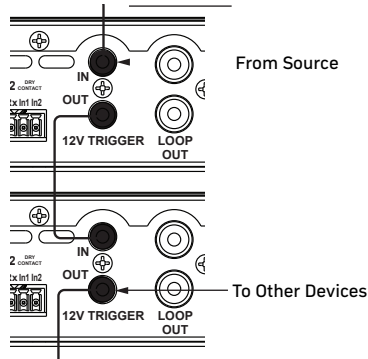

Audio Sense

If Audio Sense is enabled via setup through the web GUI, the amplifier will turn on when an audio signal is detected. The unit will enter standby mode if no signal is detected after 15 minutes. See the Configuration Utility for details on how to set up Audio Sense.

APPLICATION DIAGRAM

See the examples of applications below. These diagrams illustrate typical uses of the ESA-70V2CH amplifier.

Single Source with Stereo Output

ESA-70V2CH-500W

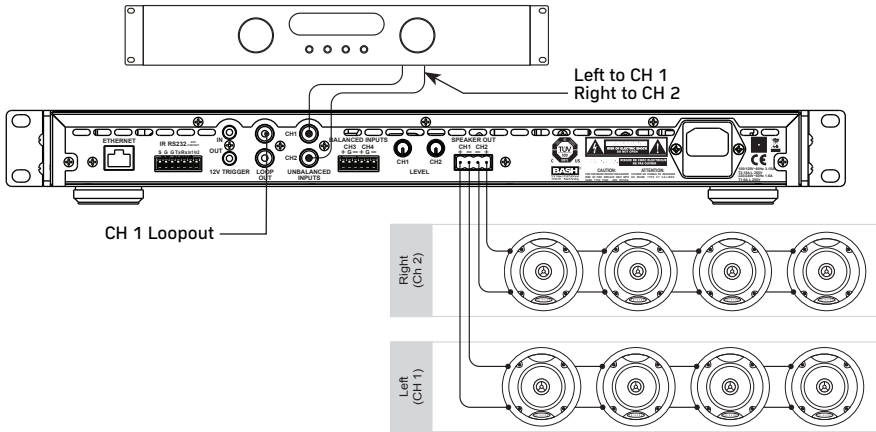

Two Sources with Two Mono Output Zones

ESA-70V2CH-150W, 300W

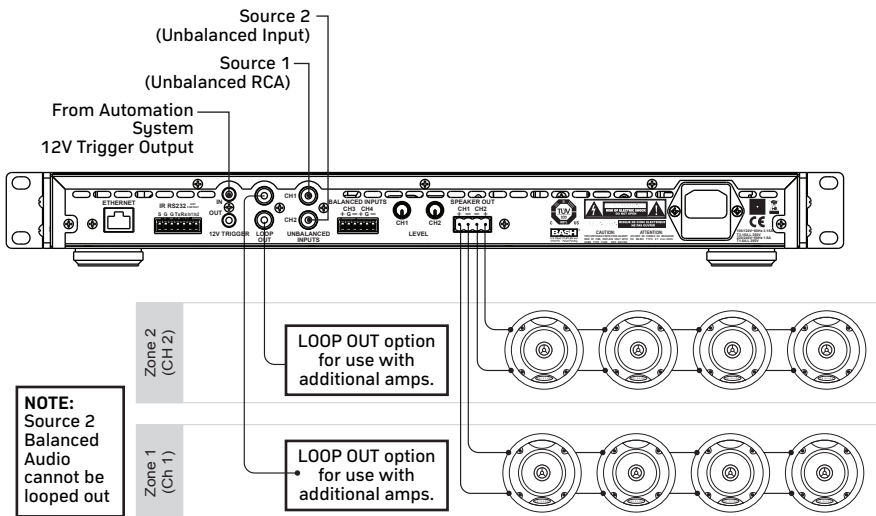

Volume Calibration

To calibrate source input gain and inline volume control level:

1. Connect all speaker and audio source wiring. Connect power to the amplifier.
2. (If applicable) Set all volume controls to their maximum volume setting.
3. Set each output level adjustment knob to 50% and set the input level for unused channels to minimum.
4. Power on the amplifier and the source to be used. Play audio typical of what will be played in the area. Set the source volume level to half. If the audio becomes distorted, turn the volume down until audio is clear.
5. Set the level adjustment for the area to a level where the volume is slightly above normal listening level. If the audio becomes distorted, experiment with changes to the source volume and the LEVEL adjustment knob until audio is clear.
6. Log in to the WebGUI and go to Configuration > Input/Output to fine tune the Gain settings for each port.

Note: The default IP address for the amplifier is **192.168.100.115**. The default username and password is “**admin**”. For more information on setup using the WebGUI, refer to the Configuration Utility Manual available on the product support tab.

Calibration Setup Tips

Poor Calibration may cause the following issues. Use the tips below to identify and correct these problems:

Distorted Audio at Normal Volume

If the LEVEL adjustment for a zone is set too high to compensate for low source volume, distortion can occur in the form of background noise or poor audio quality. This will be heard as a steady hissing or humming behind music, clipping of signal, or distortion of highs and lows.

To eliminate this issue, re-adjust the volume levels by starting at baseline settings and re-adjusting the final volume so that a maximum comfortable volume level can be reached with no distortion while using the source volume or inline control.

Inline Volume “Thump” or Play Source Audio in the Walls

If inline volume thumps or resonate in the walls, the amplifier and source volume levels are set too high. Inline volume controls should be calibrated so that they are one or two adjustment levels away from their maximum setting when audio is at the normal listening level. This will leave one to three settings above normal level for use if a little extra volume is needed.

OvrC®

Adding the ESA-70V2CH-IP to an OvrC Account

Step 1. Connect the IP Device to the Internet

The amplifier must be powered on and connected to a LAN with Internet access to activate an OvrC connection.

Refer to the manual for installation instructions. Once the device has been activated, it can be added to the account, even if the device is not online when added.

Step 2. Log Into OvrC

Create a new account at www.OvrC.com, or log into an existing account.

Step 3. Add the Device

Select “Add a Device” and enter the device’s MAC address and serial number (this information can be found next to the service tag on the product). If OvrC locates the device, directions to continue setup will be displayed. If OvrC does not locate the device, confirm, then re-enter the



MAC address and serial number.

Once setup is complete, all OvrC features can now be accessed via a smartphone or tablet application, or via the Internet at www.OvrC.com

SPECIFICATIONS

		ESA-70V2CH-150W	ESA-70V2CH-300W	ESA-70V2CH-500W
Continuous Power Output (All Channels)		150w per channel @ 70V	300w per channel @ 70V	500w per channel @ 70V
Inputs per Channel		1 unbalanced (RCA) and 1 balanced (set-screw)		
Input Sensitivity		775mV		
Input Impedance		10K Ω (unbalanced); 20K Ω (balanced)		
AUTO ON Sensitivity		2.5mV		
12 Volt Trigger Input		4.5-12V DC; 10K Ω		
12 Volt Trigger Output		12V DC; 10mA		
S/N ratio		95db A-weighted		
Frequency Response		50 Hz to 20KHz		
Distortion		0.1% THD 20 Hz-20 kHz		
Input Voltage		115V AC/230V AC		
Fuse	115V AC	T3.15AL 250V	T6.3AL 250V	T10AL 250V
	230V AC	T1.6AL 250V	T3.15AL 250V	T5AL 250V
Power Consumption		400 watts	800 watts	1200 watts
Dimensions (Inches)		17"W x 1.73"H x 14"D		17"W x 3.49"H x 15"D
Weight		11.9 lbs	12.9 lbs	17.4 lbs
Certification		Meets FCC Part 15, UL EN60065		

DIMENSIONS

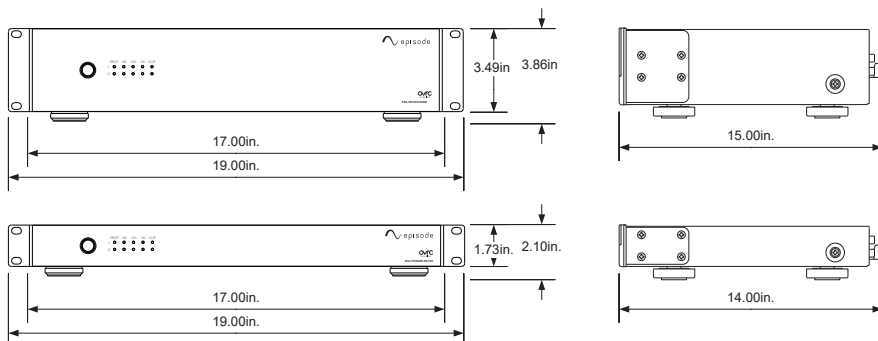

TROUBLESHOOTING

Amplifier will not turn on.	<ol style="list-style-type: none">1. Power cable to the amplifier is incorrectly connected or plugged into an outlet that does not have power. Check connections and verify power on the outlet.2. Main Power Fuse is blown. Replace fuse and ensure the AC voltage switch is set correctly on the bottom of the amplifier.
POWER LED is red.	<ol style="list-style-type: none">1. Amplifier is in Protection mode. Too much current being drawn on speaker output. Verify all wiring and connections.2. Calculate load attached to amp and configure so that wattage output is within specification.3. Amplifier is overheating. Unplug amp and let cool. Install per instructions in manual, "Positioning the Amplifier".
Hum or buzzing sound is heard.	Check RCA input cables by removing them one at time and checking to see if a connection or cable is to blame.
No audio from speakers.	<ol style="list-style-type: none">1. Verify speakers and wiring connections. Log in to the WebGUI and go to Configuration > Input/Output and use the OUTPUT test tone function to test if each output can produce sound.2. Verify correct source operation and input wiring. Turn volume in source up to an audible level.3. Is Power LED red? If so, see section above, "POWER LED is RED".
No sound from microphone input.	Set the phantom power switch to the correct mode for microphone, and verify the correct mode with microphone manufacturer.
CLIP LED illuminates some or all of the time.	Turn down the input gain. The amplifier is trying to push too much power to the speakers.

WARRANTY

2-Year Limited Warranty

Episode® Amplifiers have a 2-Year Limited Warranty. This warranty includes parts and labor repairs on all components found to be defective in material or workmanship under normal conditions of use. This warranty shall not apply to products that have been abused, modified or disassembled. Products to be repaired under this warranty must be returned to a designated service center with an assigned return authorization (RA) number. Contact technical support at support@episodeaudio.com for an RA number.

CONTACTING TECHNICAL SUPPORT

866.838.5052

support@episodeaudio.com



© 2017 Episode®
Rev: 170720-0200