

# DENON<sup>®</sup>

## PMA-1600NE

INTEGRATED AMPLIFIER

# Owner's Manual

You can print more than one page of a PDF onto a single sheet of paper.

[Front panel](#)[Rear panel](#)[Remote control  
unit](#)[Index](#)

<b>Accessories</b>	<b>4</b>
Inserting the batteries	5
Operating range of the remote control unit	5
<b>Features</b>	<b>6</b>
High quality sound	6
High performance	6
<b>Part names and functions</b>	<b>7</b>
Front panel	7
Rear panel	10
Remote control unit	12

## Connections

<b>Connecting speakers</b>	<b>17</b>
Speaker connection	19
Bi-wiring connection	20
<b>Connecting a playback device</b>	<b>21</b>
<b>Connecting a recording device</b>	<b>22</b>
<b>Connecting to a device with digital audio output connectors</b>	<b>23</b>
<b>Connecting a PC or Mac</b>	<b>24</b>
<b>Connecting the power cord</b>	<b>25</b>

## Playback

Turning the power on	27
Selecting the input source	28
Adjusting the volume	28
Turning off the sound temporarily (Muting)	28
Adjusting the tone	28
Switching the display's brightness	29
Playing CDs	29
Connecting and playing back from a computer (USB-DAC)	31
Connecting and playing back from a digital device (Coaxial/Optical)	40
Recording	41

## Settings

<b>Setting the Auto Standby mode</b>	<b>42</b>
Turning Auto Standby mode off	42
Turning Auto Standby mode on	42



## Tips

Tips	44
Troubleshooting	45

## Appendix



D/A converter	51
Explanation of terms	51
Trademark information	52
Specifications	53
Index	56



Thank you for purchasing this Denon product. To ensure proper operation, please read this owner's manual carefully before using the product. After reading this manual, be sure to keep it for future reference.

## Accessories

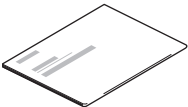
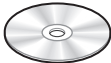
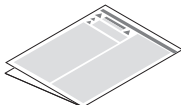
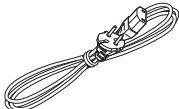
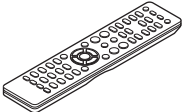
Check that the following parts are supplied with the product.

 <p>Quick Start Guide</p>	 <p>CD-ROM (Owner's Manual)</p>	 <p>Safety Instructions</p>	 <p>Power cord</p>
 <p>Remote control unit (RC-1213)</p>	 <p>R03/AAA batteries</p>		



## Inserting the batteries

- 1 Remove the rear lid in the direction of the arrow and remove it.



- 2 Insert two batteries correctly into the battery compartment as indicated.

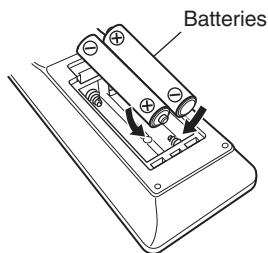

- 3 Put the rear cover back on.

### NOTE

- To prevent damage or leakage of battery fluid:
  - Do not use a new battery together with an old one.
  - Do not use two different types of batteries.
- Remove the batteries from the remote control unit if it will not be in use for long periods.
- If the battery fluid should leak, carefully wipe the fluid off the inside of the battery compartment and insert new batteries.

## Operating range of the remote control unit

Point the remote control unit at the remote sensor when operating it.

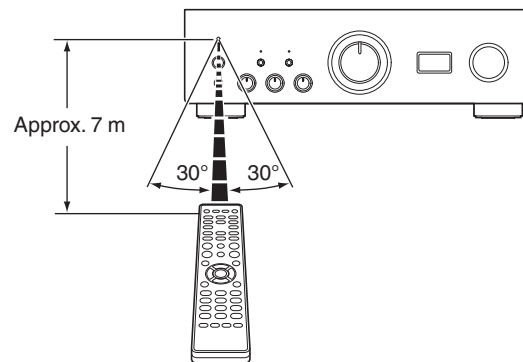

# Features

## High quality sound

- **Advanced UHC-MOS Single Push-pull Circuit**

The UHC-MOS FET is employed for the power amplifier output stage. The steady current is 30 A and the instantaneous current is 120 A. The operation stability affected by the temperature fluctuation is improved by using the dual FET selected first stage for the voltage amplifier stage. Furthermore, the phase property is stabilized up to the high range by using the cascade bootstrap circuit.

- **Power Supply**

To make the most of the Advanced UHC-MOS Single Push-pull Circuit, this powerful power supply consists of a LC mount twin transformer, schottky barrier diodes that have high current capacity, and a custom block type capacitor that is tuned for high-quality sound.

- **Mechanical Ground**

A chassis that has 6 discrete blocks shielded for each signal level and a foot made of high density materials pursue the Mechanical Ground concept, eliminating the influences caused by external vibration and preventing vibration of the transformer, the internal vibration source, from being transmitted to the amplifier circuit.

## High performance

- **Equipped with a USB-DAC function to support playback of high-resolution sound sources**

This unit supports the playback of high resolution audio formats such as DSD (2.8/5.6/11.2 MHz) and PCM files up to 384 kHz/32 bits. It provides high quality playback of high resolution files into this unit from a computer via USB-B connection.

- **DIGITAL AUDIO IN connectors (COAXIAL/OPTICAL)**

You can play back PCM signals up to 192 kHz/24 bits by inputting digital audio signals from an external device into this unit.

- **Phono Equalizer**

Even a user who is particular about analog records is satisfied because the Phono Equalizer circuit for the FET input supports MM/MC.



## Part names and functions

### Front panel

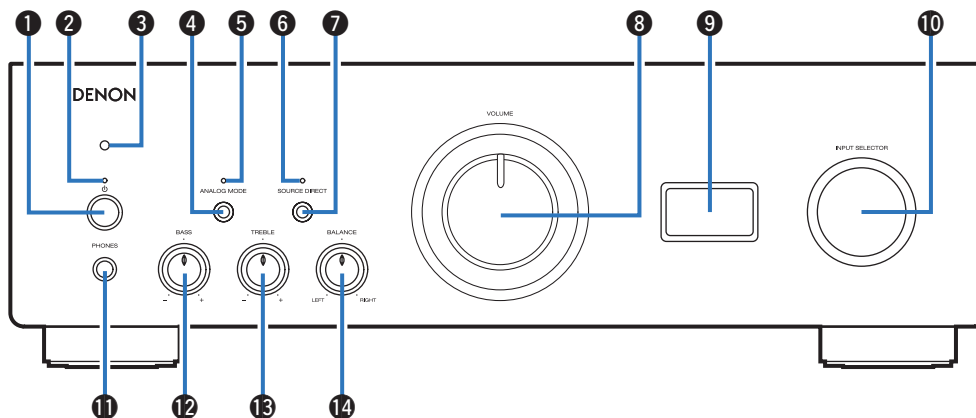

#### 1 Power operation button (⏻)

This turns the power on/off. (👉 p. 27)

#### 2 Power indicator

This is lit as follows according to the power status:

- Power on : Green
- Standby : Off
- Power off : Off
- When the protection circuit is activated : Red (blinking)

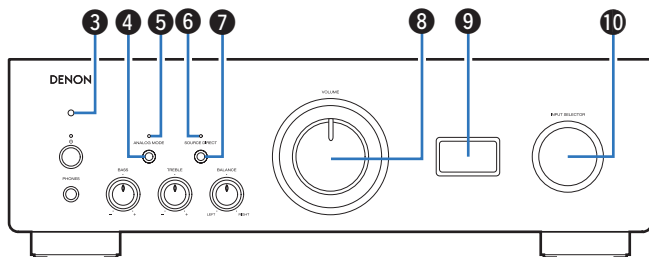

### 3 Remote control sensor

This receives signals from the remote control unit. (☞ p. 5)

### 4 ANALOG MODE button

This switches the ANALOG MODE. (☞ p. 30)

### 5 ANALOG MODE indicator

This is lit as follows according to the ANALOG MODE status:

- ANALOG MODE 1/2: Green
- ANALOG MODE off: Off

### 6 SOURCE DIRECT indicator

This is lit as follows according to the SOURCE DIRECT status:

- SOURCE DIRECT mode on: Green
- SOURCE DIRECT mode off: Off

### 7 SOURCE DIRECT button

This turns SOURCE DIRECT mode on/off. (☞ p. 29)

### 8 VOLUME knob

These adjust the volume level. (☞ p. 28)

### 9 Display

This displays information such as the input source name, type of digital audio signal and sampling frequency.

### 10 Input source select knob (INPUT SELECTOR)

This selects the input source. (☞ p. 28)



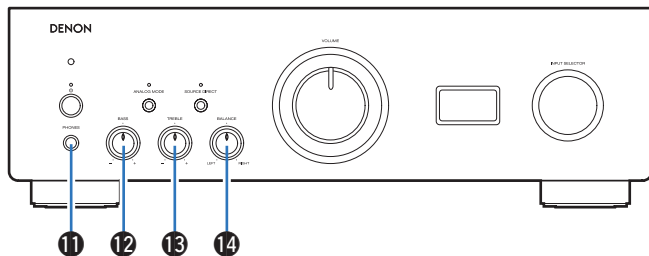

### 11 Headphones jack (PHONES)

Used to connect headphones.

Turn off speaker output when using headphones.

#### NOTE

- To prevent hearing loss, do not raise the volume level excessively when using headphones.

### 12 BASS control knob

This setting adjusts the volume level for the bass. (☞ p. 28)

### 13 TREBLE control knob

This setting adjusts the volume level for the treble. (☞ p. 28)

### 14 BALANCE control knob

This adjusts the balance of the volume output from the left and right speakers. (☞ p. 28)



- 12, 13 and 14 can be adjusted when 7 is off (SOURCE DIRECT mode is off).

## Rear panel

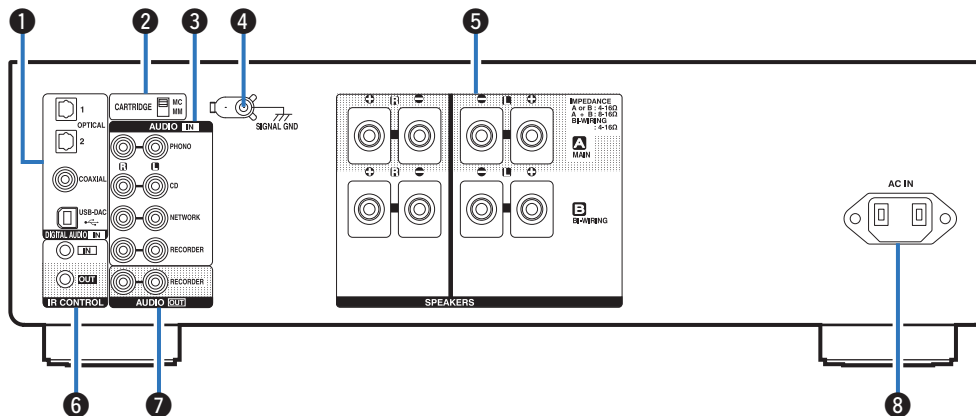

### 1 DIGITAL AUDIO IN connectors

Used to connect devices equipped with digital audio output connectors and PC.

- “Connecting to a device with digital audio output connectors” (🔗 p. 23)
- “Connecting a PC or Mac” (🔗 p. 24)

### 2 CARTRIDGE selection switch

Set this switch to MM or MC according to the type of cartridge used on your turntable.

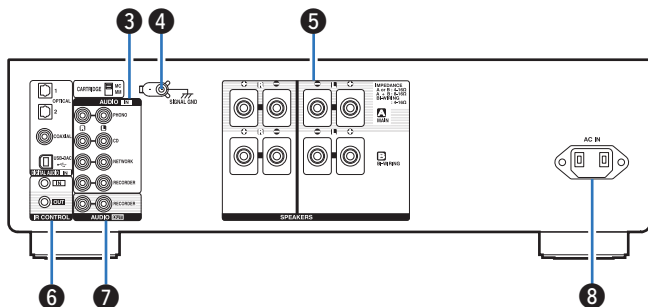

### 3 Analog audio connectors (AUDIO IN)

Used to connect devices equipped with analog audio connectors.

- “Connecting a playback device” (👉 p. 21)
- “Connecting a recording device” (👉 p. 22)

### 4 SIGNAL GND terminal

Used to connect a turntable. (👉 p. 21)

### 5 Speaker terminals (SPEAKERS)

Used to connect speakers. (👉 p. 17)

### 6 IR control input/output connectors (IR CONTROL IN/OUT)

Used to connect Denon network audio players with an IR controller.

### 7 AUDIO OUT connectors (RECORDER)

Used to connect the input connector of a recorder. (👉 p. 22)

### 8 AC inlet (AC IN)

Used to connect the power cord. (👉 p. 25)

## Remote control unit

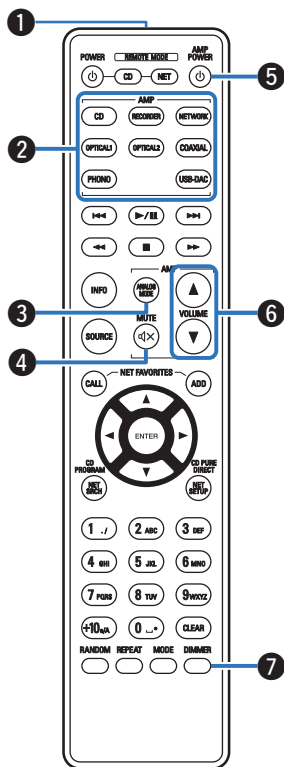

### ■ Operating this unit

- 1 Signal transmitter**  
This transmits signals from the remote control unit. (☞ p. 5)
- 2 Input source select buttons**  
This selects the input source. (☞ p. 28)
- 3 ANALOG MODE button**  
This switches the ANALOG MODE. (☞ p. 30)
- 4 MUTE button (🔇)**  
This mutes the output audio. (☞ p. 28)
- 5 Power operation button (AMP POWER ⏻)**  
This turns the power on/off (standby). (☞ p. 27)
- 6 VOLUME buttons (▲▼)**  
These adjust the volume level. (☞ p. 28)
- 7 DIMMER button**  
This switches the brightness of the display. (☞ p. 29)



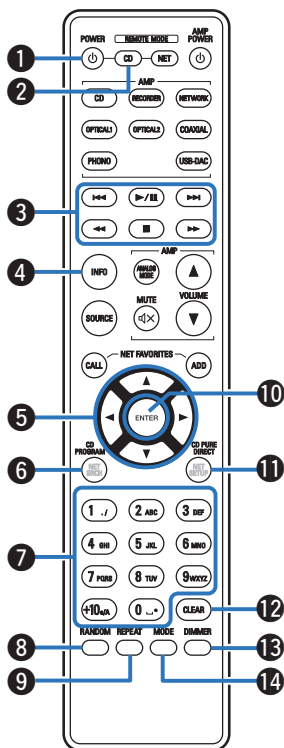

## CD player operations

A Denon CD player can be operated.

- 1 Power operation button (POWER  $\phi$ )
- 2 Remote mode select button (REMOTE MODE CD)
- 3 System buttons
  - Skip buttons ( $\lll / \ggg$ )
  - Play/pause button ( $\triangleright / \parallel$ )
  - Fast-reverse/Fast-forward buttons ( $\lll / \ggg$ )
  - Stop button ( $\blacksquare$ )
- 4 Information button (INFO)
- 5 Cursor buttons ( $\Delta \nabla \triangleleft \triangleright$ )
- 6 CD PROGRAM button
- 7 Number buttons (0 – 9, +10)
- 8 RANDOM button
- 9 REPEAT button
- 10 ENTER button
- 11 CD PURE DIRECT button
- 12 CLEAR button
- 13 DIMMER button
- 14 MODE button



- The remote control may not operate some products.



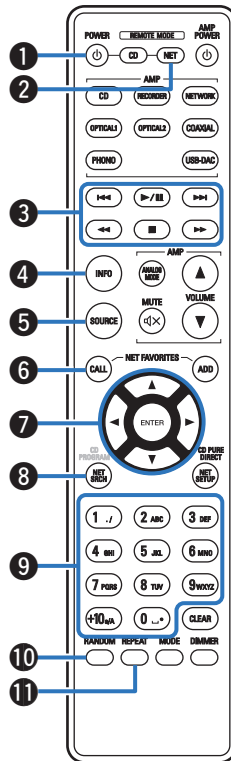

## ■ Network audio player operations

To operate a Denon network audio player, press the REMOTE MODE NET button to switch the remote control to the network audio player operation mode.

- 1 **Power operation button (POWER  $\phi$ )**
- 2 **Remote mode select button (REMOTE MODE NET)**
- 3 **System buttons**
  - Skip buttons (|◀◀ / ▶▶|)
  - Play/pause button (▶ / ||)
  - Fast-reverse/Fast-forward buttons (◀◀ / ▶▶)
  - Stop button (■)
- 4 **Information button (INFO)**
- 5 **SOURCE button**
- 6 **NET FAVORITES CALL button**
- 7 **Cursor buttons ( $\Delta \nabla \triangleleft \triangleright$ )**
- 8 **NET SRCH button**
- 9 **Number buttons (0 – 9, +10)**
- 10 **RANDOM button**
- 11 **REPEAT button**

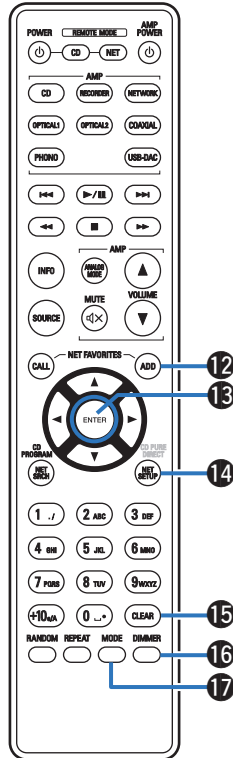

12 NET FAVORITES ADD button

13 ENTER button

14 NET SETUP button

15 CLEAR button

16 DIMMER button

17 MODE button



- The amp can be operated with the amp operation buttons even when the remote control mode is "NET".
- When using it, also refer to the operating instructions of the other devices.
- The remote control may not operate some products.



## ■ Contents

Connecting speakers	17
Connecting a playback device	21
Connecting a recording device	22
Connecting to a device with digital audio output connectors	23
Connecting a PC or Mac	24
Connecting the power cord	25

### NOTE

- Do not plug in the power cord until all connections have been completed.
- Do not bundle power cords together with connection cables. Doing so can result in humming or noise.

## ■ Cables used for connections

Provide necessary cables according to the devices you want to connect.

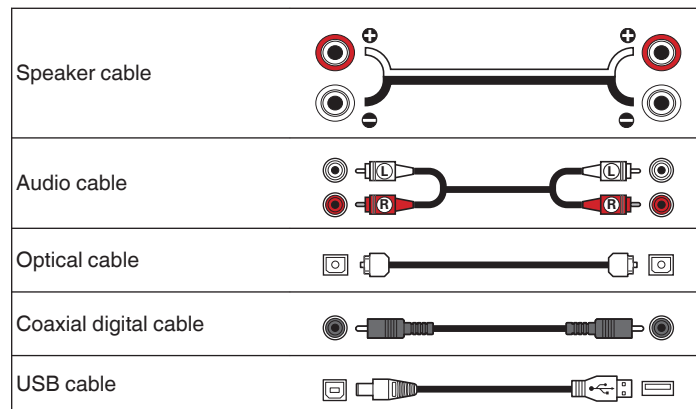



# Connecting speakers

## NOTE

- Disconnect this unit's power plug from the power outlet before connecting the speakers.
- Connect so that the speaker cable core wires do not protrude from the speaker terminal. The protection circuit may be activated if the core wires touch the rear panel or if the + and - sides touch each other. ("Protection circuit" (p. 52))
- Never touch the speaker terminals while the power cord is connected. Doing so could result in electric shock.
- Use speakers with impedances within the ranges shown below to suit how they are used.

Speaker terminals used on this unit	No. of connected speakers	Speaker Impedance
<b>SPEAKERS A (Standard connection)</b>	2 (one set)	4 – 16 Ω/ohms
<b>SPEAKERS B</b>	2 (one set)	4 – 16 Ω/ohms
<b>SPEAKERS A and SPEAKERS B</b>	4 (two sets)	8 – 16 Ω/ohms
<b>SPEAKERS A and SPEAKERS B (Bi-wiring connection)</b>	2 (one set)	4 – 16 Ω/ohms

## ■ Connecting the speaker cables

Carefully check the left (L) and right (R) channels and + (red) and – (black) polarities on the speakers being connected to this unit, and be sure to connect the channels and polarities correctly.

- 1 Peel off about 10 mm of sheathing from the tip of the speaker cable, then either twist the core wire tightly or terminate it.**



- 2 Turn the speaker terminal counterclockwise to loosen it.**



- 3 Insert the speaker cable's core wire to all the way into the speaker terminal.**



#### 4 Turn the speaker terminal clockwise to tighten it.



##### Speaker terminal dimensions

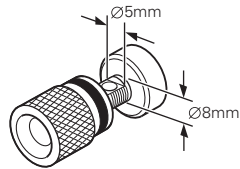

## Speaker connection

This unit is equipped with two sets of speaker terminals (SPEAKER A and SPEAKER B). One set of speakers can be connected to each set of terminals, and a total of two sets of speakers can be connected.

The same signal is output from the SPEAKERS A and SPEAKERS B terminals.

When only one set of speakers is to be connected, use either the SPEAKERS A or SPEAKERS B terminals.

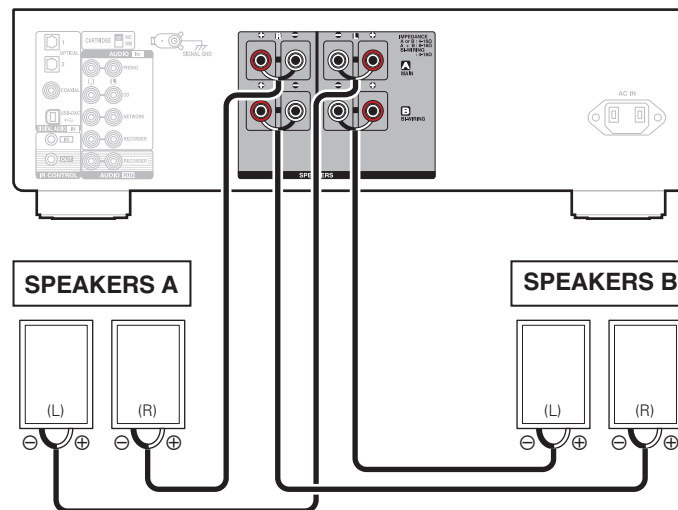

## Bi-wiring connection

This connection limits the effects of signal interference between the high range speakers (tweeters) and low range speakers (woofers), allowing you to enjoy high quality playback.

When bi-wiring with bi-wireable speakers, connect the mid and high range terminals to SPEAKERS A (or SPEAKERS B), the low range terminals to SPEAKERS B (or SPEAKERS A).

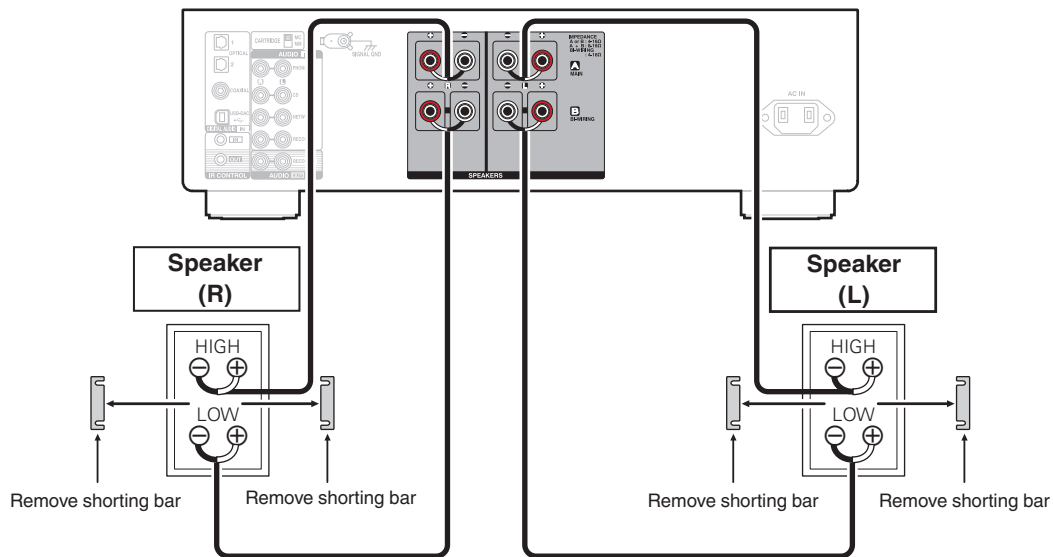

## Connecting a playback device

You can connect turntables, CD players and network audio players to this unit.

If you set this unit's input source to "PHONO" and you accidentally increase the volume without having a turntable connected, you may hear a hum noise from the speakers.

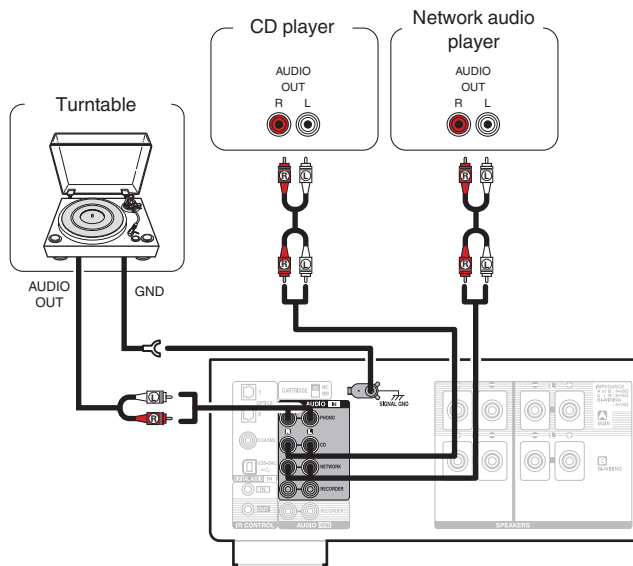

### NOTE

- The earth terminal (SIGNAL GND) of this unit is not for safety grounding purposes. If this terminal is connected when there is a lot of noise, the noise can be reduced. Note that depending on the turntable, connecting the ground line may have the reverse effect of increasing noise. In this case, it is not necessary to connect the ground line.



- The PHONO input terminals are equipped with a short pin-plug. Remove this plug to connect a record player. Store the removed short pin-plug in a safe place so as not to lose it.



## Connecting a recording device

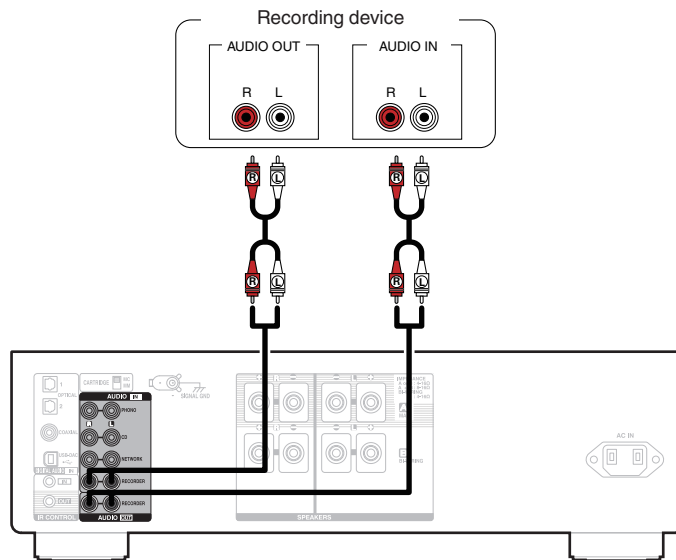

### NOTE

- Never insert the short-circuiting pin plug into the recording output connectors (AUDIO OUT RECORDER). Doing so could result in damage.



## Connecting to a device with digital audio output connectors

Use this connection to input digital audio signals to this unit, and convert the signals for playback using the D/A converter of this unit. (🔍 p. 31)

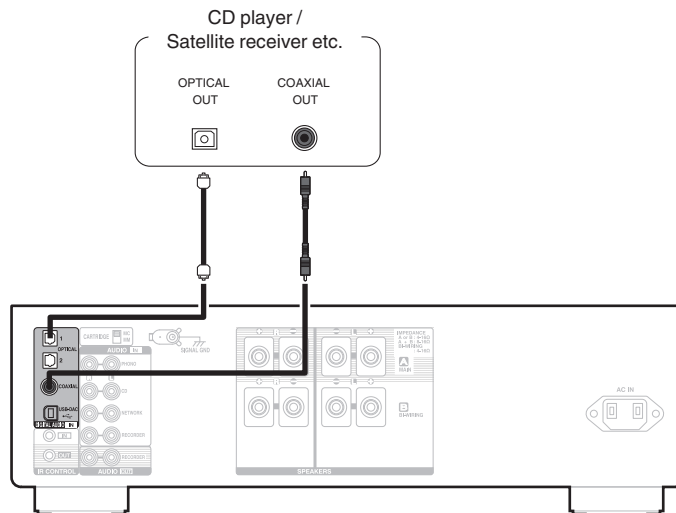

### NOTE

- Linear PCM signals with a sampling frequency of 32 kHz, 44.1 kHz, 48 kHz, 88.2 kHz, 96 kHz, 176.4 kHz, or 192 kHz can be input into this device.
- Do not input non-PCM signals, such as Dolby Digital, DTS and AAC. This causes noise and could damage the speakers.



## Connecting a PC or Mac

By connecting a computer to the USB-DAC port on the rear panel of this unit using a commercially available USB connecting cable, this unit can be used as a D/A converter. (📖 p. 31)

### NOTE

- Before USB connecting this unit to your computer, install the driver software in your computer. (📖 p. 32)
- Download the driver software from the PMA-1600NE page of the Denon website.
- Use a cable that is 3 m or less to connect to the computer.

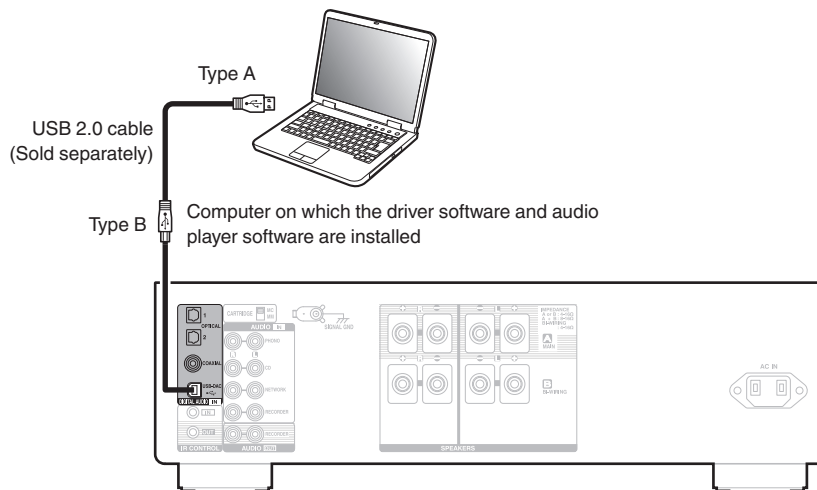



## Connecting the power cord

Wait until all connections have been completed before connecting the power cord.

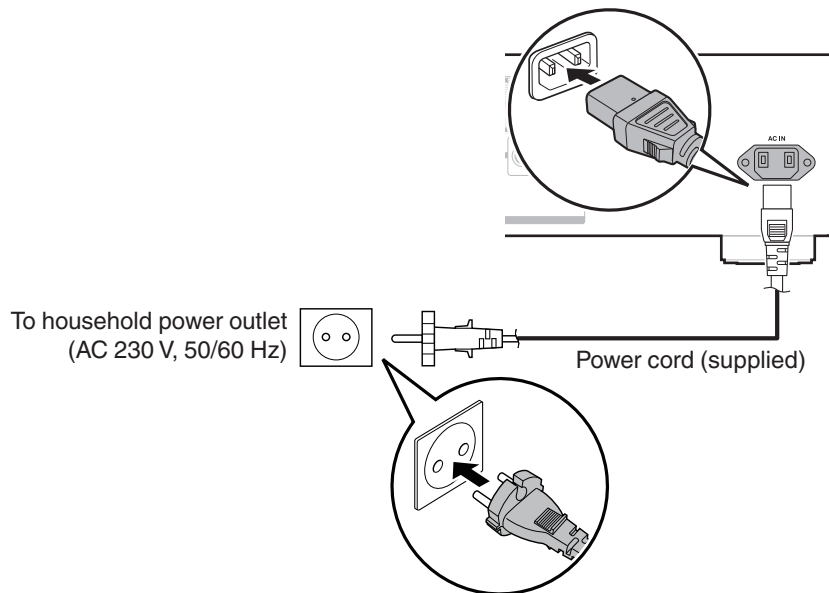

## ■ Contents

Turning the power on	27
Selecting the input source	28
Adjusting the volume	28
Turning off the sound temporarily (Muting)	28
Adjusting the tone	28
Switching the display's brightness	29
Playing CDs	29
Connecting and playing back from a computer (USB-DAC)	31
Connecting and playing back from a digital device (Coaxial/Optical)	40
Recording	41



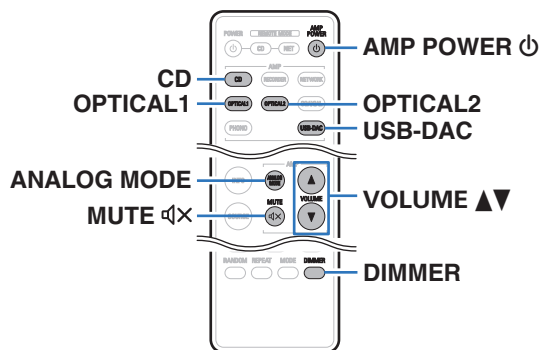

### Power indicator

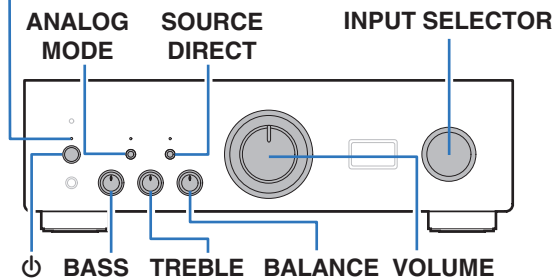

## Turning the power on

- 1 Press  $\text{\textcircled{P}}$  on this unit to turn the power on.  
The power indicator lights green.



- Press AMP POWER  $\text{\textcircled{P}}$  on the remote control unit to turn on power from standby mode.

## Switching the power to standby

- 1 Press AMP POWER  $\text{\textcircled{P}}$ .  
The unit switches to standby mode.

### NOTE

- Power continues to be supplied to some of the circuitry even when the power is in the standby mode. When leaving home for long periods of time or when going on vacation, either press  $\text{\textcircled{P}}$  on the main unit to turn off the power, or unplug the power cord from the power outlet.



## Selecting the input source

### 1 Press the input source select button to be played back.

The selected input source is displayed on the display of this unit.



- You can also select the input source by turning INPUT SELECTOR on the main unit.

## Adjusting the volume

### 1 Use VOLUME ▲▼ to adjust the volume.



- You can also adjust the volume by turning VOLUME on the main unit.

## Turning off the sound temporarily (Muting)

### 1 Press MUTE $\text{M}$ .

"MUTING" is displayed on the display of this unit.



- To cancel mute, press MUTE  $\text{M}$  again.

## Adjusting the tone

### 1 Press SOURCE DIRECT on the main unit to turn off source direct mode.

The SOURCE DIRECT indicator turns off.

### 2 Turn the BASS, TREBLE and BALANCE to adjust the tone.



## Switching the display's brightness

The brightness of the display can be adjusted to one of four levels.

### 1 Press DIMMER.



- The DIMMER button also controls the Denon's Super Audio CD Player DCD-1600NE, so the DCD-1600NE can be operated simultaneously with this unit. When the two units have different settings, press and hold in the button for lease 2 seconds to reset them both to the default setting, then make the desired setting.
- The display brightness is set to most brightly by default.

## Playing CDs

This section uses playback from a CD as an example.

### 1 Press the input source select button (CD) to switch the input source to "CD".

"CD" is displayed on the display of this unit.

### 2 Playback the CD.

### 3 Use VOLUME ▲▼ to adjust the volume.

## ■ Playback in source direct mode

The signal does not pass through the tone adjustment circuitry (BASS, TREBLE and BALANCE), resulting in playback of a higher sound quality.

### 1 Press SOURCE DIRECT on the main unit to turn on source direct mode.

The SOURCE DIRECT indicator lights.



## ■ Playback in ANALOG MODE

When the ANALOG MODE is turned on to playback an analog source (PHONO, CD, NETWORK, RECORDER), power to the digital input circuit and the display turn off. This enables you to enjoy high sound quality audio playback without sound quality being affected by noise that occurs from the digital control circuit.

### 1 Press ANALOG MODE to turn analog mode on.

- The ANALOG MODE indicator lights.

Press ANALOG MODE to toggle between “ANALOG MODE Off”, “ANALOG MODE 1” and “ANALOG MODE 2”.

<b>ANALOG MODE Off:</b>	ANALOG MODE is not used.
<b>ANALOG MODE 1:</b>	Turns the digital input circuit power off.
<b>ANALOG MODE 2:</b>	Turns the digital input circuit power and display off.



- A digital input source (COAXIAL, OPTICAL 1/2, USB-DAC) cannot be selected when ANALOG MODE is on.
- The input source automatically switches to CD if ANALOG MODE is turned on during playback of a digital input source (COAXIAL, OPTICAL 1/2, USB-DAC).
- Communication between this unit and the computer is disconnected if ANALOG MODE is turned on when a computer is connected to the USB-DAC input connector of this unit. If the unit cannot communicate with the computer after turning ANALOG MODE off again, disconnect and reconnect the USB cable or restart the audio player on the computer.
- When the analog mode is switched, the mute circuit is activated for about 5 seconds.



## Connecting and playing back from a computer (USB-DAC)

You can enjoy high-quality audio playback from the D/A converter built in to this unit by inputting music files into this unit from a computer via USB connection.

- Before USB connecting this unit to your computer, install the driver software in your computer.
- Drivers do not need to be installed for Mac OS.
- Also, you can use whichever commercially available or downloadable player software you like to playback files on your computer.

### ■ Computer (System Requirements)

#### OS

- Windows 7, Windows 8, Windows 8.1 or Windows 10
- Mac OS X 10.9, 10.10 or 10.11

#### USB

- USB 2.0: USB High speed/USB Audio Class Ver.2.0

#### NOTE

- This unit was checked the operation using the system requirements by us, but it does not guarantee the operation of all systems.

- **DSD is a registered trademark.**
- **Microsoft, Windows 7, Windows 8, Windows 8.1 and Windows 10 are either registered trademarks or trademarks of Microsoft Corporation in the United States and/or other countries.**
- **ASIO is a trademark of Steinberg Media Technologies GmbH.**
- **Apple, Macintosh and Mac OS are trademarks of Apple Inc., registered in the U.S. and other countries.**

Windows OS Installing the dedicated driver (🔗 p. 32)

Mac OS Audio Device Settings (🔗 p. 38)



## ■ Installing the dedicated driver (Windows OS only)

### □ Installing the driver software

- 1 Disconnect the USB cable between your PC and the unit.**
  - The driver software cannot be installed correctly if your PC is connected to the unit by a USB cable.
  - If the unit and your computer are connected by a USB cable and the computer is switched on before installation, disconnect the USB and restart the computer.
- 2 Download the dedicated driver from the “Download” section of the PMA-1600NE page of the Denon website onto your PC.**
- 3 Unzip the downloaded file, and double-click the exe file.**

## 4 Install the driver.

- ① Select the language to use for the installation.
- ② Click “OK”.

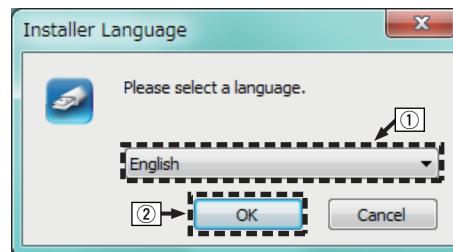



- ③ The wizard menu is displayed. Click “Next”.

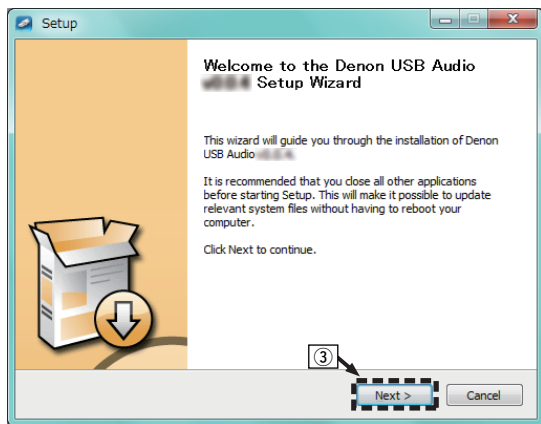

- ④ Read the Software Licensing Agreement, and click “I accept the terms of the License Agreement”.
- ⑤ Click “Next”.

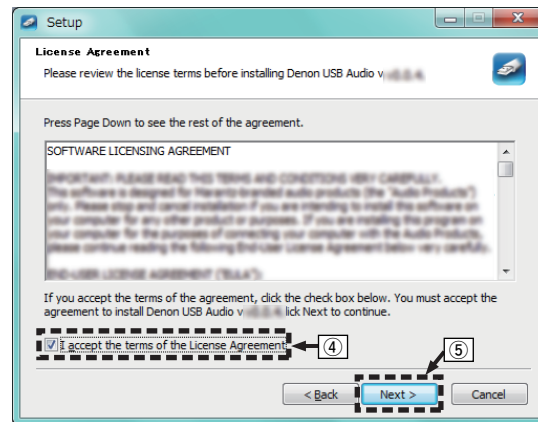

- ⑥ Click “Install” on the installation start dialog.
- The installation starts. Do not perform any operation on the PC until the installation is completed.

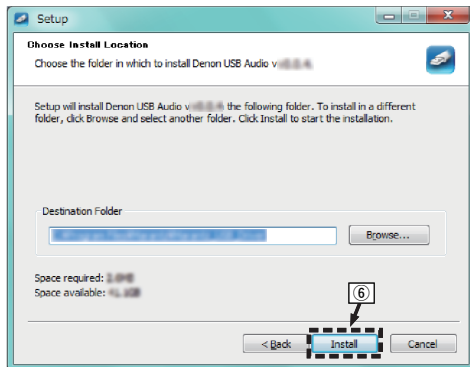

- ⑦ Click “Next”.

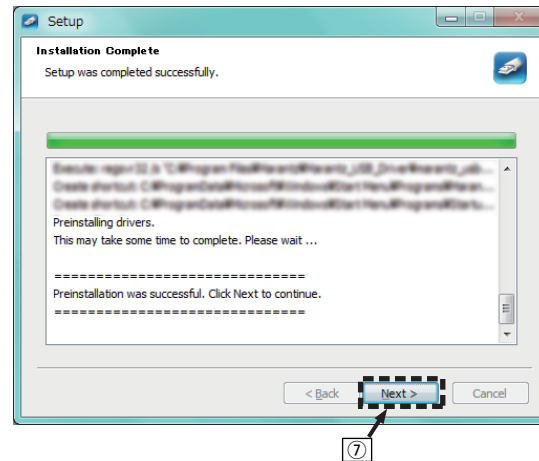

⑧ When the installation is completed, click “Finish”.

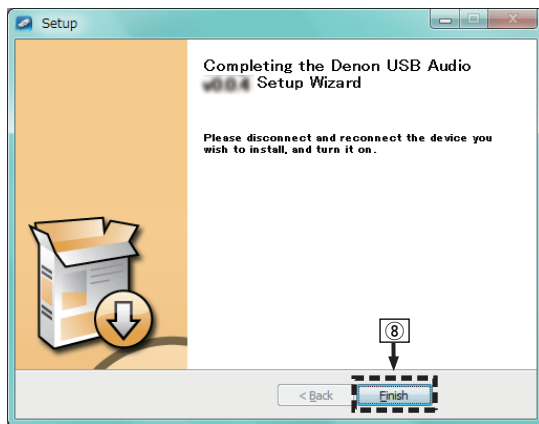

⑨ Click “Yes”.



## 5 With the unit power off, connect the unit and PC using a USB cable (sold separately).

- For details on connections, see “Connecting a PC or Mac” (🔗 p. 24).

## 6 Press **⏻** on this unit.

- When the unit power is turned on, the PC automatically finds and connects to the unit.

## 7 Press the input source select button (USB-DAC) to switch the input source to “USB-DAC”.

## 8 Checking the installed driver.

- ① Click the “Start” button and click “Control Panel” on the PC.
  - The control panel setting list is displayed.
- ② Click the “Sound” icon.
  - The sound menu window is displayed.
- ③ Check that there is a checkmark next to “Default Device” under in “PMA-1600NE” of the “Playback” tab.
  - When there is a checkmark for a different device, click “PMA-1600NE” and “Set Default”.

## 9 Checking audio output.

Outputs a TEST signal from the PC and checks the audio output from the USB-DAC function.

- ① Select “PMA-1600NE” and click “Properties”.
  - The PMA-1600NE Properties window is displayed.

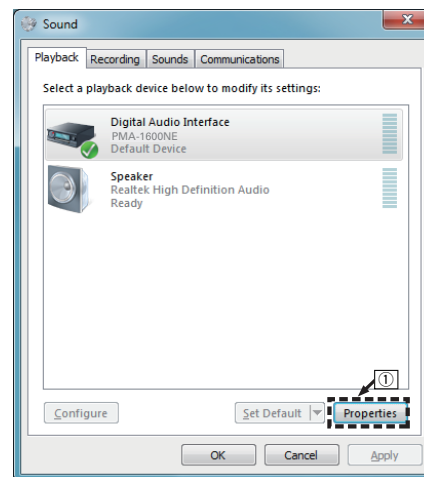

- ② Click the “Advanced” tab.
- ③ Select the sampling rate and bit rate to be applied to the D/A converter.
  - It is recommended that “2 channel, 24 bit, 192000 Hz (Studio Quality)” is selected (Windows 7).
  - It is recommended that “2 channel, 32 bit, 192000 Hz (Studio Quality)” is selected (Windows 8/Windows 8.1/Windows 10).
- ④ Click “Apply”.
- ⑤ Click “Test”.
  - Check that audio from this unit is output from the PC.

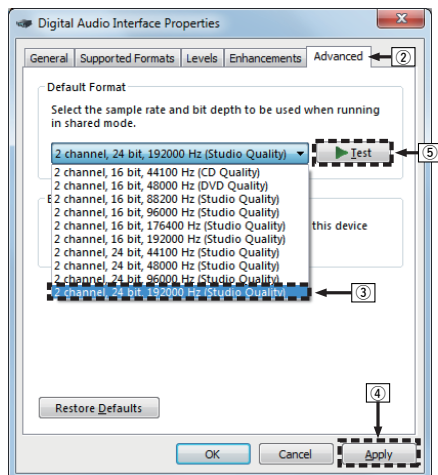

## NOTE

- The dedicated driver must be installed in the PC before this unit is connected to a PC. Operation will not occur correctly if connected to the PC before the dedicated driver has been installed.
- Operation may fail in some PC hardware and software configurations.
- Player software supporting the Audio Stream Input Output (ASIO) driver is required to play files with a sampling frequency of 352.8 kHz/384 kHz without downsampling. Check your player software before playing files with the ASIO driver.
- Please see the FAQ at [www.denon.com](http://www.denon.com) if you experience any issues getting audio to play from your computer through the this unit. You may also want to check the support pages for your audio player application.



## ■ Audio Device Settings (Mac OS X only)

- ① With the unit power off, connect the unit and Mac using a USB cable (sold separately).
  - For the connection procedure, refer to the “Connecting a PC or Mac” section. (👉 p. 24)
- ② Press  $\phi$ .
- ③ Press the input source select button (USB-DAC) to switch the input source to “USB-DAC”.
- ④ Move the cursor to “Go” on the computer screen, and then click “Utilities”.
  - The utility list is displayed.
- ⑤ Double-click “Audio MIDI Setup”.
  - The “Audio Devices” window is displayed.
- ⑥ Check that “Use this device for sound output” is checked in “PMA-1600NE”.
  - If a different device is checked, select and “Secondary click” on “PMA-1600NE”, and then select “Use this device for sound output”.

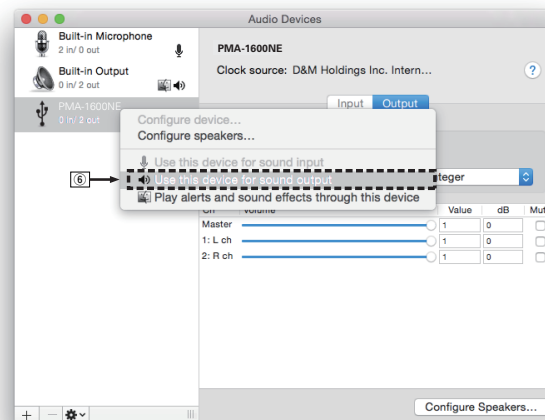

- ⑦ Select the “PMA-1600NE” format.
- It is normally recommended to set the format to “384000.0 Hz” and “2ch-32 bit Integer”.

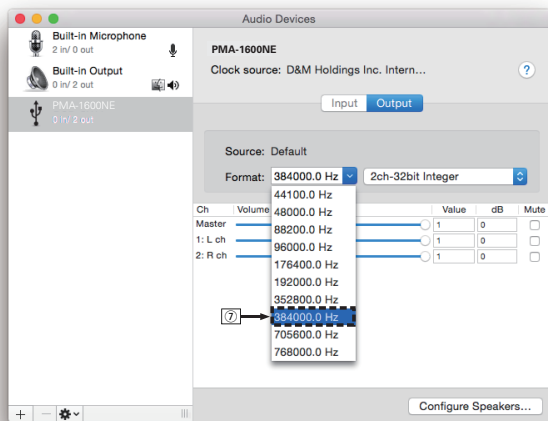

- ⑧ Quit Audio MIDI Setup.

## ■ Playback

Install the desired player software on your computer beforehand.  
Use the rear panel USB-DAC port to connect this unit to a computer.

### 1 Press the input source select button (USB-DAC) to switch the input source to “USB-DAC”.

“USB-DAC” is displayed on the display of this unit.  
Start playback on the computer’s player software.

The digital audio signal that is being input is shown as follows in the display.

“USB: PCM  
xxxxkHz” or “USB: DSD  
xxxMHz”  
(xxxx is the sampling frequency.)

- If the sampling frequency cannot be detected, “Unlocked” will be displayed.
- “Unsupported” is displayed when audio signals that are not supported by this unit are input.

## ■ Audio signals that can be played back

See “D/A converter” (🔍 p. 51).

### NOTE

- Perform operations such as playback and pause on the computer. At this time, you cannot perform operations with buttons on this unit or the remote control.
- When this unit is functioning as a D/A converter, sound is not output from the computer's speakers.
- If the computer is disconnected from this unit while the computer music playback software is running, the playback software may freeze. Always exit the playback software before disconnecting the computer.
- When an error occurs on the computer, disconnect the USB cable and restart the computer.
- The sampling frequency of the music playback software and sampling frequency displayed on this unit may differ.
- Use a cable that is 3 m or less to connect to the computer.

## Connecting and playing back from a digital device (Coaxial/Optical)

- 1 **Connect digital device to this unit.** (🔍 p. 23)
- 2 **Press the input source select button (COAXIAL or OPTICAL 1/2) to switch the input source to “COAXIAL” or “OPTICAL 1/2”.**

The digital audio signal that is being input is shown as follows in the display.

“COAX:PCM                      or                      “OPT1:PCM                      or                      “OPT2:PCM  
xxxxkHz”                      or                      xxxxkHz”                      or                      xxxxkHz”

(xxxx is the sampling frequency.)

- If the sampling frequency cannot be detected, “Unlocked” will be displayed.
- “Unsupported” is displayed when audio signals that are not supported by this unit are input.





## ■ Audio signals that can be played back

See “D/A converter” (🔍 p. 51).

### NOTE

- Do not input non-PCM signals, such as Dolby Digital, DTS and AAC. This causes noise and could damage the speakers.
- If the sampling frequency switches, muting may operate for 1 – 2 seconds, cutting the sound.

## Recording

Audio signals input into this unit can be output to an external recording device. When recording audio from a playback device connected to this unit, audio can be recorded with the playback device still connected to this unit.

- 1 Press  on this unit to turn the power on.**
- 2 Press the input source select button to switch to the input source from which you want to record.**  
The selected input source is displayed on the display of this unit.
- 3 Recording starts.**
  - For information on operations, see the owner’s manual of the recording device.



## Setting the Auto Standby mode

You can set the unit to automatically switch to standby mode if the unit is not operated for 30 minutes when there is no audio input (Auto Standby mode).

Auto Standby mode is set to on by default.

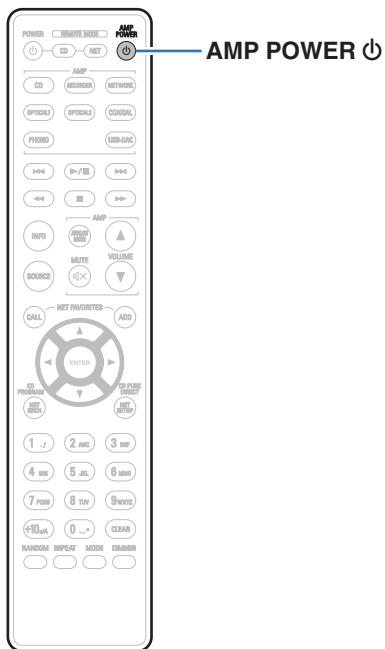

### Turning Auto Standby mode off

- 1 Press and hold **AMP POWER**  on the remote control unit for more than 5 seconds to turn the Auto Standby mode off.

"AutoStby Off" is displayed on the display of this unit.

### Turning Auto Standby mode on

- 1 Press and hold **AMP POWER**  on the remote control unit for more than 5 seconds to turn the Auto Standby mode on.

"AutoStby On" is displayed on the display of this unit.

## ■ Contents

### Tips

I want to adjust the tone myself	44
I want sound playback that is faithful to the original sound	44
I want to enjoy higher sound quality from the analog input source	44
I want to use bi-wiring compatible speakers	44

### Troubleshooting

Power does not turn on / Power is turned off	46
Operations cannot be performed through the remote control unit	47
No sound comes out	48
Desired sound does not come out	48
Sound is interrupted or noise occurs	49
PC or Mac files cannot be played back	50
Audio from digital devices cannot be played back (Coaxial/Optical)	50



## Tips

### I want to adjust the tone myself

- Use the BASS, TREBLE and BALANCE knobs to adjust the sound as desired. (👉 p. 28)

### I want sound playback that is faithful to the original sound

- Set the Source Direct mode on. (👉 p. 29)

### I want to enjoy higher sound quality from the analog input source

- Set the Analog mode on. (👉 p. 30)

### I want to use bi-wiring compatible speakers

- This unit is compatible with bi-wiring connections. Enjoy high quality playback by using bi-wiring connections. (👉 p. 20)



## Troubleshooting

If a problem should arise, first check the following:

1. **Are the connections correct?**
2. **Is the set being operated as described in the owner's manual?**
3. **Are the other devices operating properly?**

If this unit does not operate properly, check the corresponding symptoms in this section.

If the symptoms do not match any of those described here, consult your dealer as it could be due to a fault in this unit. In this case, disconnect the power immediately and contact the store where you purchased this unit.



## ■ Power does not turn on / Power is turned off

Symptom	Cause / Solution	Page
Power is not turned on.	<ul style="list-style-type: none"> <li>Check whether the power plug is correctly inserted into the power outlet.</li> </ul>	<u>25</u>
Power automatically turns off.	<ul style="list-style-type: none"> <li>The Auto Standby mode is set. The Auto Standby mode switches the unit to standby mode when the unit is not operated for approximately 30 minutes. To disable the Auto Standby mode, press and hold the AMP POWER  button for more than 5 seconds when the Auto Standby mode is enabled.</li> </ul>	<u>42</u>
Power turns off and the power indicator flashes in red approx. every 0.5 seconds.	<ul style="list-style-type: none"> <li>The protection circuit has been activated due to a rise in temperature within this unit. Turn the power off, wait about an hour until this unit cools down sufficiently, and then turn the power on again.</li> </ul>	<u>52</u>
	<ul style="list-style-type: none"> <li>Please re-install this unit in a place having good ventilation.</li> </ul>	—
Power turns off and the power indicator flashes in red approx. every 0.25 seconds.	<ul style="list-style-type: none"> <li>Check the speaker connections. The protection circuit may have been activated because speaker cable core wires came in contact with each other or a core wire was disconnected from the connector and came in contact with the rear panel of this unit. After unplugging the power cord, take corrective action such as firmly re-twisting the core wire or taking care of the connector, and then reconnect the wire.</li> </ul>	<u>17</u>
	<ul style="list-style-type: none"> <li>Turn down the volume and turn on the power again.</li> </ul>	<u>27</u>
When the power is turned on, the power indicator flashes red approx. every 0.25 seconds.	<ul style="list-style-type: none"> <li>This unit's amplifier circuit has failed. Turn off the power and please contact the Denon service adviser.</li> </ul>	—



## ■ Operations cannot be performed through the remote control unit

Symptom	Cause / Solution	Page
Operations cannot be performed through the remote control unit.	• Batteries are worn out. Replace with new batteries.	<u>5</u>
	• Operate the remote control unit within a distance of about 7 m from this unit and at an angle of within 30°.	<u>5</u>
	• Remove any obstacle between this unit and the remote control unit.	—
	• Insert the batteries in the proper direction, checking the ⊕ and ⊖ marks.	<u>5</u>
	• The set's remote control sensor is exposed to strong light (direct sunlight, inverter type fluorescent bulb light, etc.). Move the set to a place in which the remote control sensor will not be exposed to strong light.	—
	• When using a 3D video device, the remote control unit of this unit may not function due to effects of infrared communications between units (such as TV and glasses for 3D viewing). In this case, adjust the direction of units with the 3D communications function and their distance to ensure they do not affect operations from the remote control unit of this unit.	—



## ■ No sound comes out

Symptom	Cause / Solution	Page
No sound comes out of speakers.	• Check the connections for all devices.	<u>16</u>
	• Insert connection cables all the way in.	—
	• Check that input connectors and output connectors are not reversely connected.	—
	• Check cables for damage.	—
	• Check that speaker cables are properly connected. Check that cable core wires come in contact with the metal part on speaker terminals.	<u>17</u>
	• Securely tighten the speaker terminals. Check speaker terminals for looseness.	<u>17</u>
	• Check that the proper input source is selected.	<u>28</u>
	• The volume is set to the minimum level. Adjust the volume to a suitable level.	<u>28</u>
	• Cancel the muting mode.	<u>28</u>
• No sound is output from the speakers when headphones are connected.	<u>9</u>	

## ■ Desired sound does not come out

Symptom	Cause / Solution	Page
No sound comes out of a specific speaker.	• Check that speaker cables are properly connected.	<u>17</u>
	• Adjust the BALANCE control knob.	<u>28</u>
The left and right of stereo sound is reversed.	• Check whether the left and right speakers are connected to the correct speaker terminals.	<u>17</u>





## ■ Sound is interrupted or noise occurs

Symptom	Cause / Solution	Page
When playing a record, the sound is distorted.	• Adjust to a proper needle pressure.	—
	• Check the tip of the needle.	—
	• Replace the cartridge.	—
When playing a record, a humming noise comes out of the speakers.	• Check that the turntable is connected correctly.	<u>21</u>
	• If there is a TV or AV device near the turntable, such devices may affect the playback sound. Install the turntable in a location as far away as possible from the TV or other AV devices.	—
When playing a record, a humming noise comes out of the speakers when the volume is high. (Howling phenomenon)	• Install the turntable and speakers as far from each other as possible.	<u>21</u>
	• The vibrations from the speakers are being transmitted to the player through the floor. Use cushions, etc., to absorb the speakers' vibrations.	—
Sound is interrupted during playback of tracks saved on a computer.	• Do not start applications other than the player software while playing music on your computer.	—



## ■ PC or Mac files cannot be played back

Symptom	Cause / Solution	Page
This unit is not recognized on the computer.	• Reconnect the USB cable to the USB port on your computer. When this unit is still not recognized after reconnection, connect to a different USB port.	<a href="#">24</a>
	• Restart your computer.	—
	• Check the OS of your computer.	<a href="#">31</a>
	• When your computer is running on Windows, a dedicated driver software should be installed.	<a href="#">32</a>
This unit is not selected as the playback device.	• Select this unit as the playback device in the sound settings on the computer.	<a href="#">31</a>
“Unlocked” is displayed.	• When digital audio signals cannot be detected properly, “Unlocked” is displayed.	<a href="#">39</a>
“Unsupported” is displayed.	• “Unsupported” is displayed when audio signals that are not supported by this unit are input. Check the settings on your computer or player software.	<a href="#">39</a>
	• If the computer you use is “Mac OS”, please check if the “PMA-1600NE” format is set below “384000.0 Hz” using the “Audio MIDI Setup”.	<a href="#">38</a>

## ■ Audio from digital devices cannot be played back (Coaxial/Optical)

Symptom	Cause / Solution	Page
“Unlocked” is displayed.	• When digital audio signals cannot be detected properly, “Unlocked” is displayed.	<a href="#">40</a>
“Unsupported” is displayed.	• “Unsupported” is displayed when audio signals that are not supported by this unit are input. Check the audio output signal format from your digital device.	<a href="#">40</a>



## D/A converter

### ■ Specifications of supported audio signals

#### □ USB-DAC

	Sampling frequency	Bit length
DSD (2-channel)	2.8/5.6/11.2 MHz	1 bit
Linear PCM (2-channel)	44.1/48/88.2/96/176.4/ 192/352.8/384 kHz	16/24/32 bits

#### □ Coaxial/Optical

	Sampling frequency	Bit length
Linear PCM (2-channel)	32/44.1/48/88.2/96/ 176.4/192 kHz	16/24 bits

## Explanation of terms

### DSD (Direct-Stream Digital)

One of the audio data recording methods, it is the signal aspect used to store audio signals on a super audio CD, and is  $\Delta$ - $\Sigma$  modulated digital audio.

### Sampling frequency

Sampling involves taking a reading of a sound wave (analog signal) at regular intervals and expressing the height of the wave at each reading in digitized format (producing a digital signal).

The number of readings taken in one second is called the “sampling frequency”. The larger the value, the closer the reproduced sound is to the original.

### Linear PCM

This is an uncompressed PCM (Pulse Code Modulation) signal. This is the same system used for CD audio but uses 192 kHz, 96 kHz, and 48 kHz sampling frequencies on Blu-ray Disc or DVD and provides higher resolution than CD.



**Speaker impedance**

This is an AC resistance value, indicated in  $\Omega$  (ohms).

Greater power can be obtained when this value is smaller.

**Source direct**

Playback with higher fidelity to the source becomes possible, as input audio signals are output by bypassing the audio quality-control circuits (BASS/TREBLE/BALANCE).

**Protection circuit**

This is a function to prevent damage to devices within the power supply when an abnormality such as an overload, excess voltage occurs or over temperature for any reason.

If a malfunction occurs in this unit, the power indicator blinks red and the unit switches to standby mode.

## Trademark information



Adobe, the Adobe logo and Reader are either registered trademarks or trademarks of Adobe Systems Incorporated in the United States and/or other countries.



# Specifications

---

## ■ Power amplifier section

<b>Rated Output Power:</b>	2-channel driving (CD → SP OUT) 70 W + 70 W (8 Ω/ohms, 20 Hz - 20 kHz, T.H.D. 0.07 %) 140 W + 140 W (4 Ω/ohms, 1 kHz, T.H.D. 0.7 %)
<b>Total harmonic distortion:</b>	0.01 % (Rated output: -3 dB), 8 Ω/ohms, 1 kHz
<b>Output terminals:</b>	Speaker A or B: 4 – 16 Ω/ohms Speaker A + B: 8 – 16 Ω/ohms Suited for headphones/stereo headphones

## ■ Pre amplifier section

<b>Input Sensitivity/Input Impedance:</b>	PHONO (MM): 2.5 mV / 47 kΩ/kohms PHONO (MC): 200 μV / 100 Ω/ohms CD, NETWORK, RECORDER: 125 mV / 47 kΩ/kohms (SOURCE DIRECT: Off) 125 mV / 23 kΩ/kohms (SOURCE DIRECT: On)
<b>RIAA Deviation:</b>	PHONO: 20 Hz – 20 kHz ±0.5 dB
<b>Maximum Input:</b>	PHONO (MM): 130 mV / 1 kHz PHONO (MC): 10 mV / 1 kHz



## ■ Overall performance

<b>SN Ratio (A network):</b>	PHONO (MM): 89 dB (With input terminals short-circuited, 5 mV input signal) PHONO (MC): 74 dB (With input terminals short-circuited, 0.5 mV input signal) CD, NETWORK, RECORDER: 108 dB (input terminals short-circuited)
<b>Frequency response:</b>	5 Hz – 100 kHz (0 – -3 dB)
<b>Tone control:</b>	BASS: 100 Hz $\pm$ 8 dB TREBLE: 10 kHz $\pm$ 8 dB

### • Digital input signal format

<b>Format:</b>	Digital audio interface (Linear PCM)
<b>Coaxial input:</b>	0.5 V <sub>p-p</sub> / 75 $\Omega$ /ohms
<b>Optical input:</b>	More than – 27 dBm
<b>Optical wavelength:</b>	660 nm

## ■ General

<b>Power supply:</b>	AC230 V, 50/60 Hz
<b>Power consumption:</b>	295 W
<b>Power consumption in standby mode:</b>	0.2 W

For the purpose of improvement, the specifications and design are subject to change without notice.



## ■ Dimensions (Unit : mm)

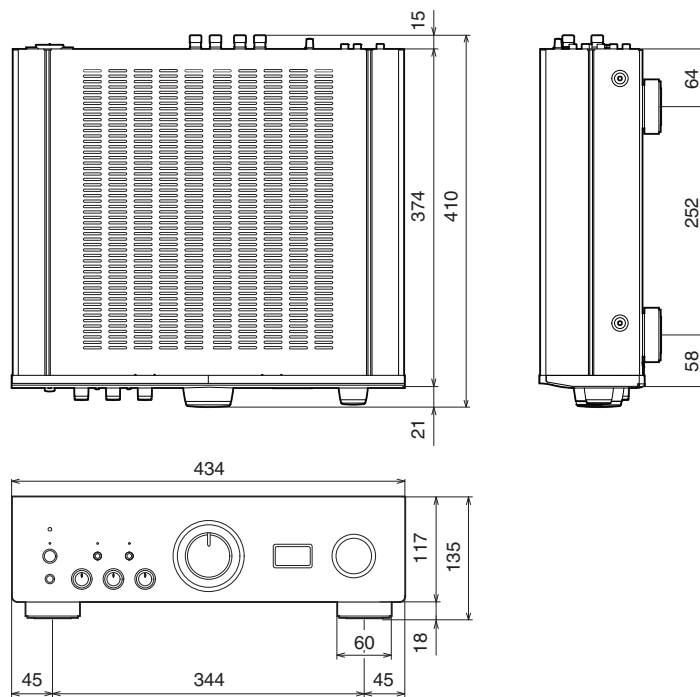

## ■ Weight: 17.6 kg

# Index

<b>A</b>		<b>M</b>		<b>T</b>	
Auto Standby mode .....	42	Muting .....	28	Tips .....	44
<b>B</b>		<b>N</b>		<b>TREBLE</b> .....	
BALANCE .....	28	Network audio player .....	21	Troubleshooting .....	45
BASS .....	28	<b>P</b>		Turntable .....	21
Bi-wiring .....	20	PC .....	24	<b>U</b>	
<b>C</b>		Protection circuit .....	52	USB-DAC .....	31
CD player .....	21, 23	<b>R</b>		<b>V</b>	
<b>D</b>		Recording device .....	22	Volume .....	28
D/A Converter .....	31	Remote control unit .....	12	<b>S</b>	
<b>I</b>		<b>S</b>		Satellite receiver .....	
Input source .....	28	Source direct .....	29, 52	Speaker impedance .....	
Install the driver .....	32	Speakers .....	17		





**DENON®**

[www.denon.com](http://www.denon.com)

3520 10479 00AD

Copyright © 2016 D&M Holdings Inc. All Rights Reserved.