

Ceiling Mount Arms  
Landscape  
49-100 inch Displays

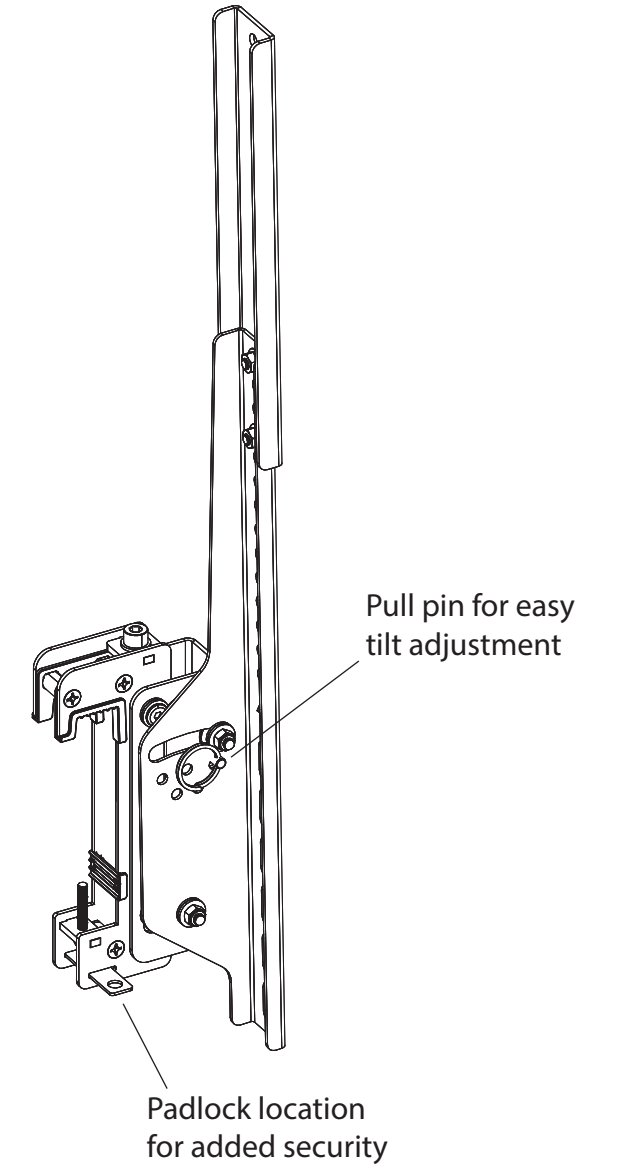
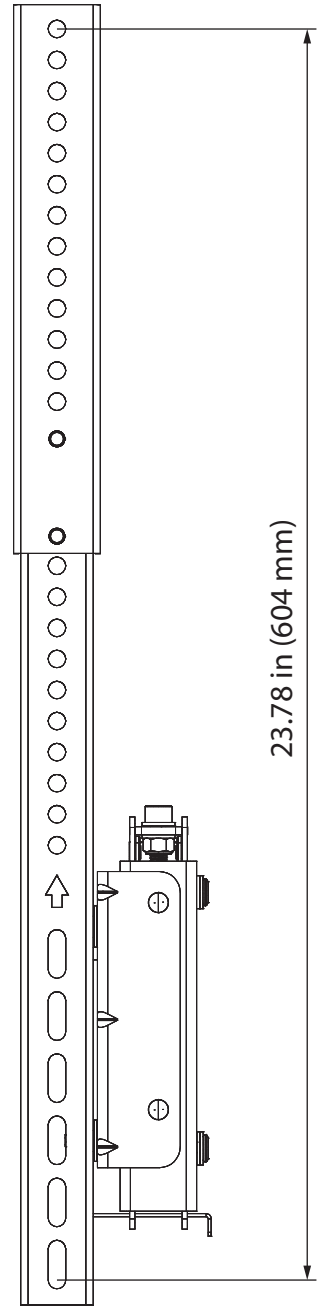
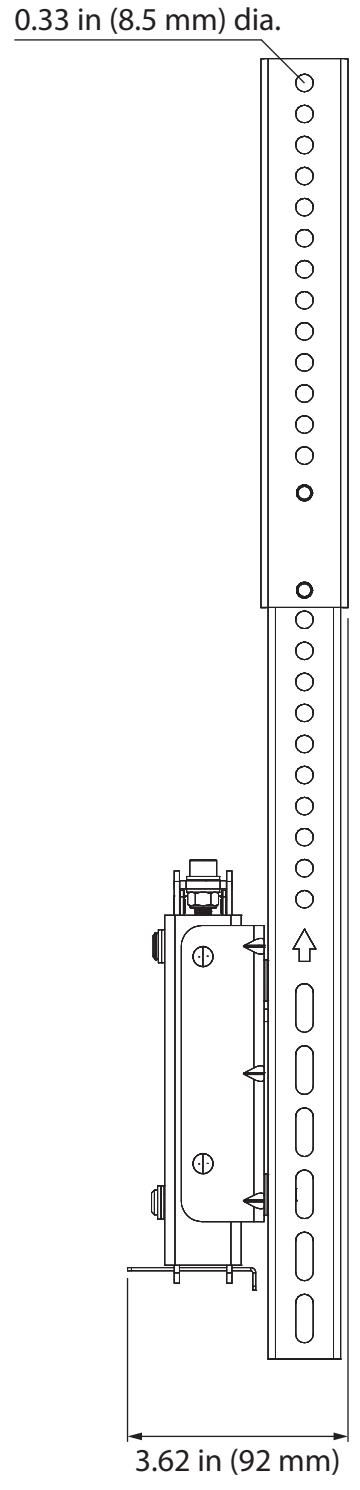
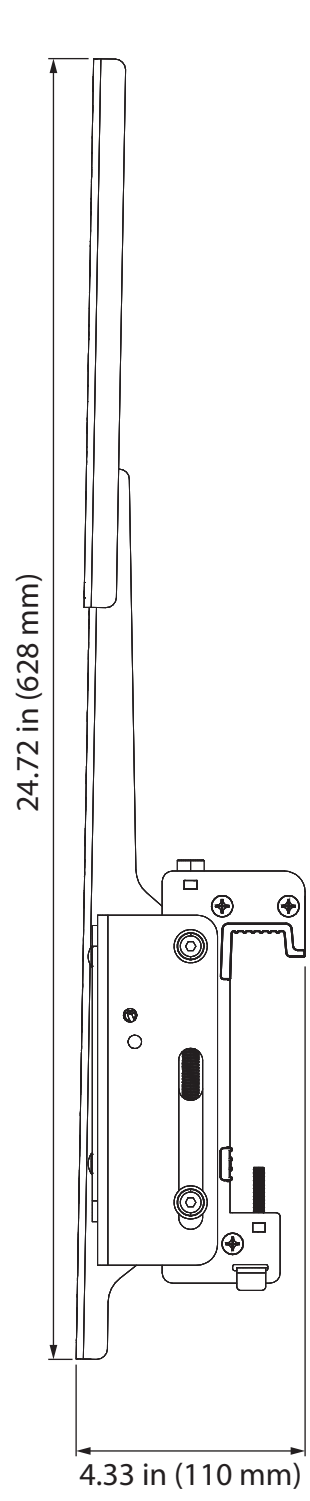

PROPRIETARY AND CONFIDENTIAL

THE INFORMATION CONTAINED IN THIS DRAWING IS THE SOLE PROPERTY OF STRONG MOUNTS AND LIFTS. ANY REPRODUCTION IN PART OR AS A WHOLE WITHOUT THE WRITTEN PERMISSION OF STRONG ONE IS PROHIBITED.

CUSTOMER PRINT

SIZE B	DRAWING NUMBER SM-CB-CM-LARM-100	DWG REV A
DO NOT SCALE DRAWING		SHEET 1 of 1