

Ceiling Mount Arms
Landscape
24-55 inch Displays

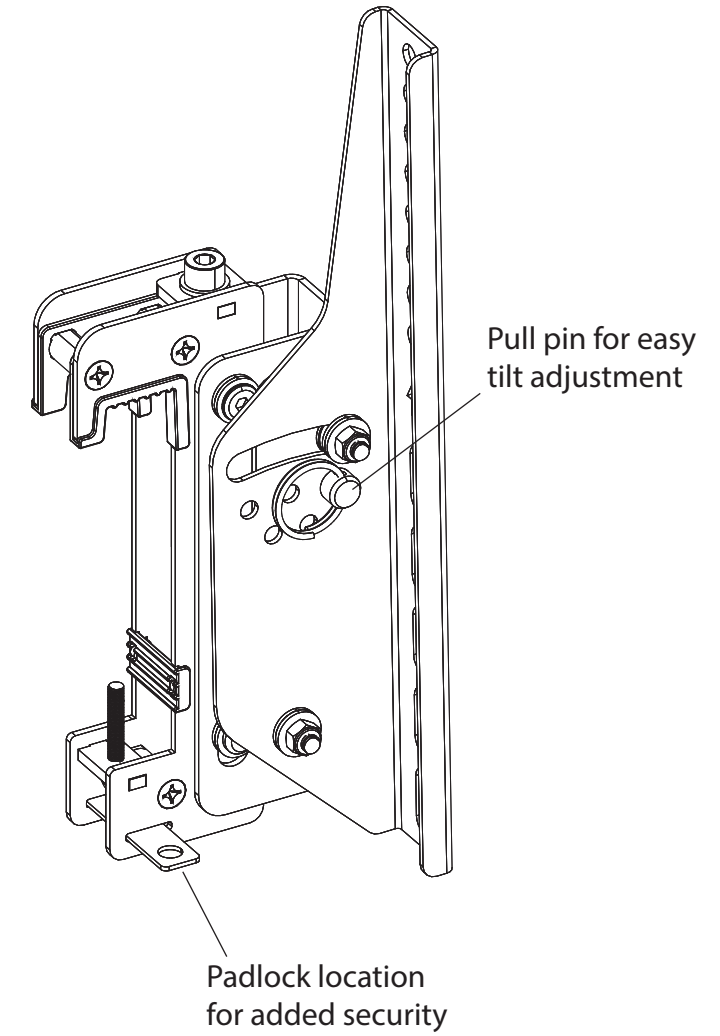
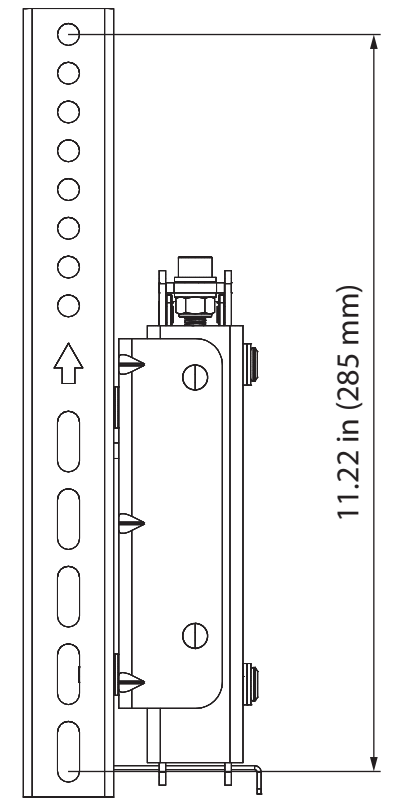
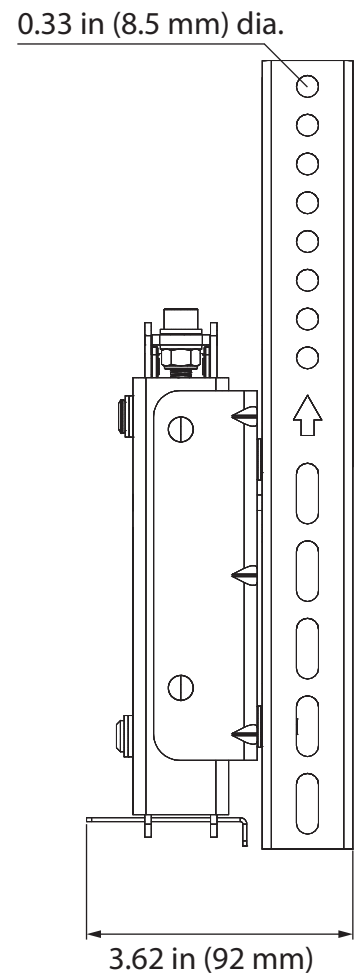
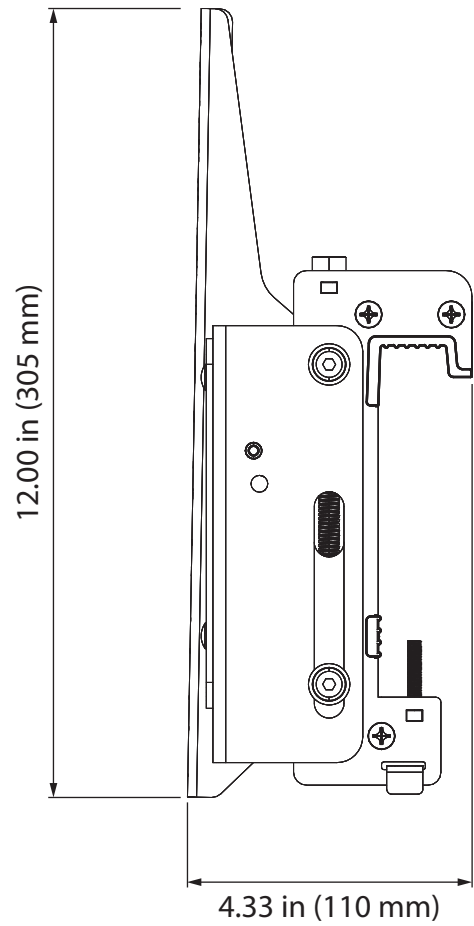

PROPRIETARY AND CONFIDENTIAL
THE INFORMATION CONTAINED IN THIS DRAWING IS THE SOLE PROPERTY OF STRONG MOUNTS AND LIFTS. ANY REPRODUCTION IN PART OR AS A WHOLE WITHOUT THE WRITTEN PERMISSION OF STRONG ONE IS PROHIBITED.

CUSTOMER PRINT

SIZE B	DRAWING NUMBER SM-CB-CM-LARM-55	DWG REV A
DO NOT SCALE DRAWING		SHEET 1 of 1