

Universal Fit Adjustable Extension Pole

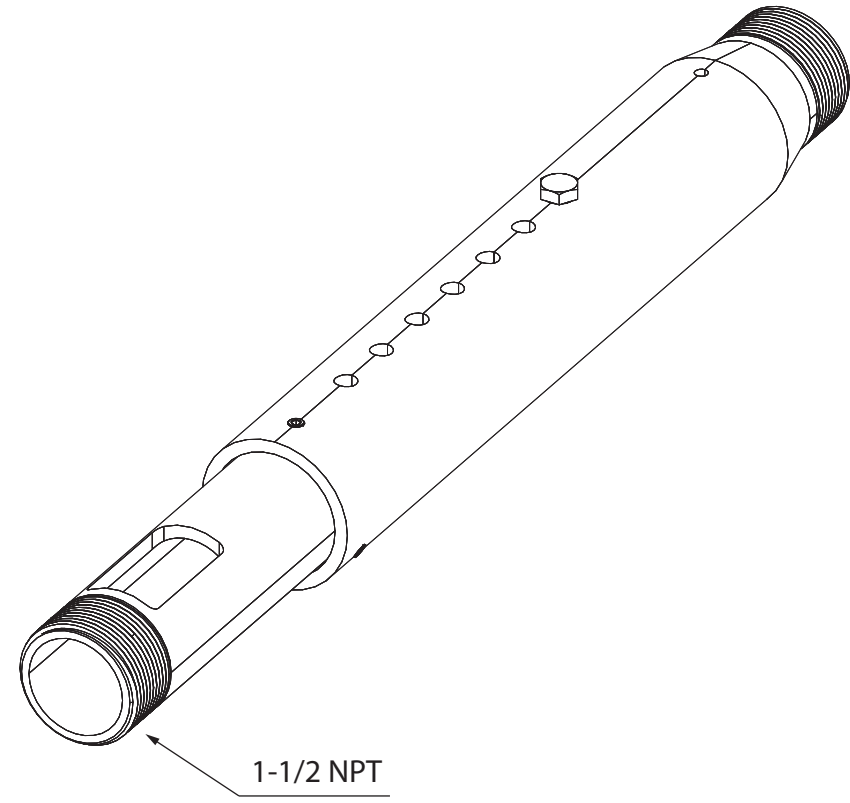

SM-ADJPOLE-9-BLK, -WH

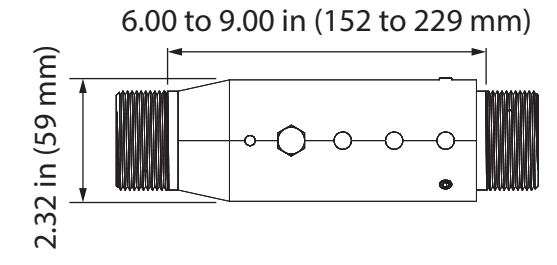

SM-ADJPOLE-12-BLK, -WH

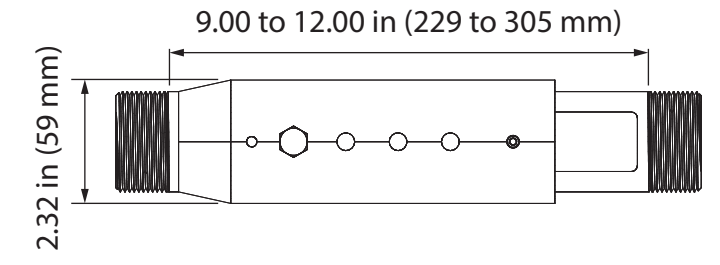

SM-ADJPOLE-18-BLK, -WH

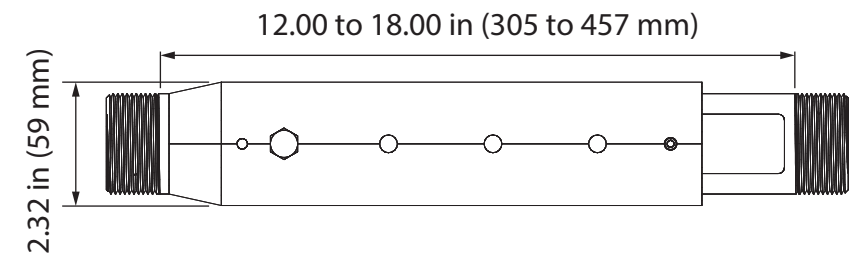

SM-ADJPOLE-24-BLK, -WH

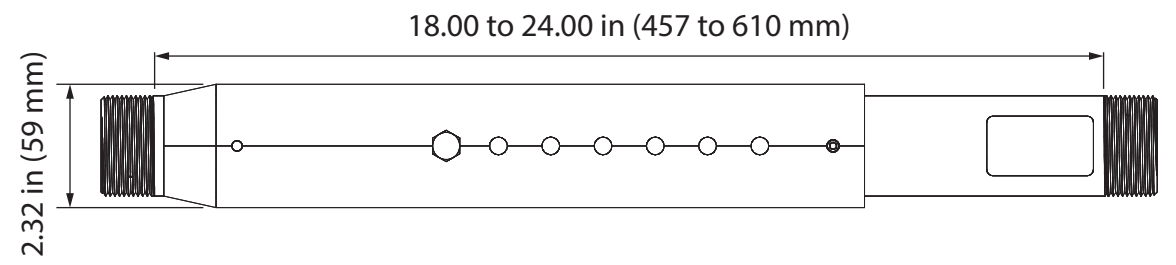

SM-ADJPOLE-36-BLK, -WH

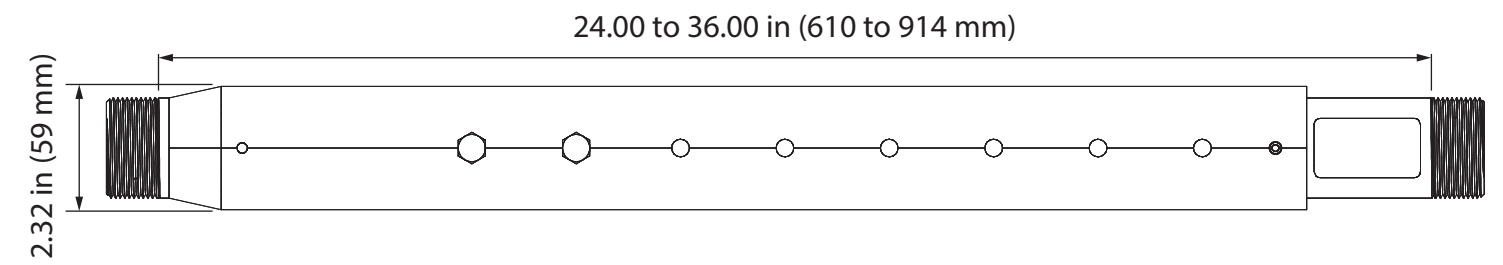

SM-ADJPOLE-48-BLK, -WH

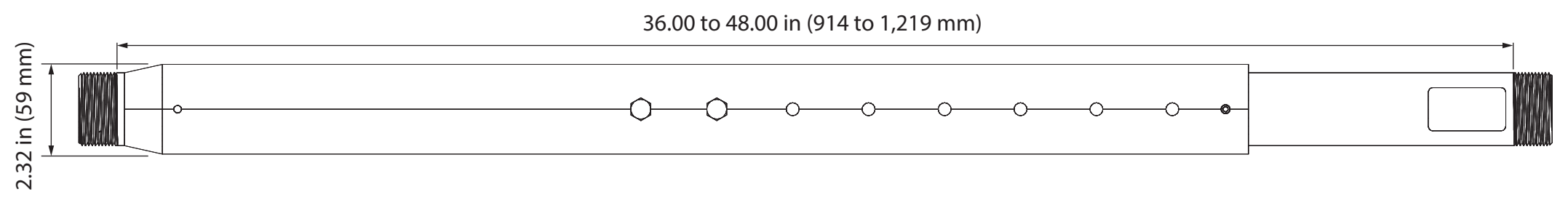

PROPRIETARY AND CONFIDENTIAL
 THE INFORMATION CONTAINED IN THIS DRAWING IS THE SOLE PROPERTY OF STRONG MOUNTS AND LIFTS. ANY REPRODUCTION IN PART OR AS A WHOLE WITHOUT THE WRITTEN PERMISSION OF SNAP ONE IS PROHIBITED.

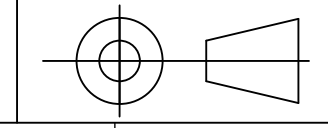

CUSTOMER PRINT



SIZE B	DRAWING NUMBER	DWG REV A
DO NOT SCALE DRAWING		SHEET 1 of 1