

ATTACHING THE MOUNT TO THE IPAD

1. Remove the 4 thumbscrews to separate the bezel from the base plate.
2. Place the iPad on the bezel, face down as shown. Ensure the iPad fits snugly in the bezel. (For iPad 2 installation, see the additional manual).
3. Ensure the rubber bumper is seated properly on the base plate.
4. Place the base plate over the bezel and iPad.
5. Secure the base plate to bezel and iPad with the 4 thumb screws. (Optional phillips head #6-32 x 3/8" screws can also be used to hold the base plate to the bezel).

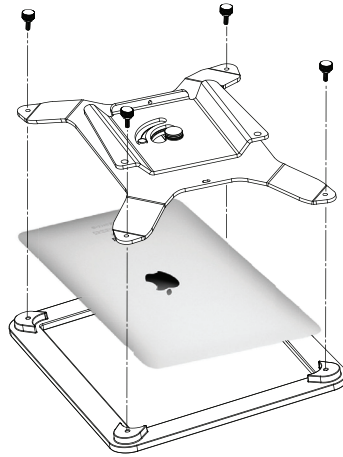

FINAL ASSEMBLY

1. Slide the lift off plate into the wall plate. Make sure the lift off plate is seated properly.
2. Secure the lift off plate to the wall plate using the lock screw.

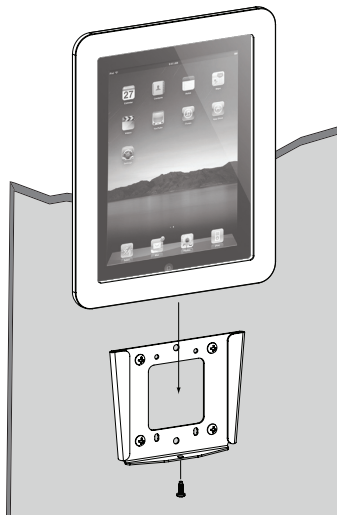

SM-PAD-LIFT

Strong™ Lift-off Mount for iPad®
with 90 Degree Rotation (Black)



Lifetime Limited Warranty
Strong™ Mounts have a Lifetime Limited Warranty. This warranty includes parts and labor repairs on all components found to be defective in material or workmanship under normal conditions of use. This warranty shall not apply to products which have been abused, modified or disassembled. Products to be repaired under this warranty must be returned to SnapAV or a designated service center with prior notification and an assigned return authorization number (RA).

For Technical Support call 1.866.838.5052

110713

HARDWARE KIT



#12x2.5" Phillips
Sheet Metal Screw (x2)

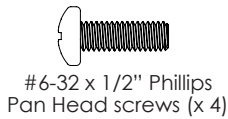

#6-32 x 1/2" Phillips
Pan Head screws (x 4)

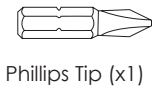

Phillips Tip (x1)



Concrete Wall
Anchor (x2)

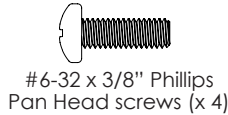

#6-32 x 3/8" Phillips
Pan Head screws (x 4)

BOX CONTENTS

- (1) SM-PAD-LIFT mount
- (1) Instruction manual
- (1) Ipad 2 kit
- (1) Hardware kit

TOOLS REQUIRED

- 5/32" x 2 1/2" drill bit and Stud finder for Drywall installation
- 5/16" x 2 1/2" Masonry drill bit for Concrete installation
- Philips head screw driver
- Electric or portable drill
- Hammer
- Level

INSTALLATION INSTRUCTIONS

INSTALLING THE WALL PLATE (DRYWALL)

IMPORTANT! For safety reasons, this mount must be secured to a wood stud. The stud must be capable of supporting the combined weight of the mount and the display.

1. Use a high-quality stud finder to locate the single stud where you want to install your mount. Mark both edges of the stud to help identify the exact center.
2. Place the wall plate over the center of the marked stud and level it. Mark the two holes for securing the mount and set the wall plate aside.
3. Drill a 2-1/2" deep pilot hole at each marked location using an electric or portable drill and a 5/32" drill bit.
4. Move the wall plate into position and secure it using wood screws.

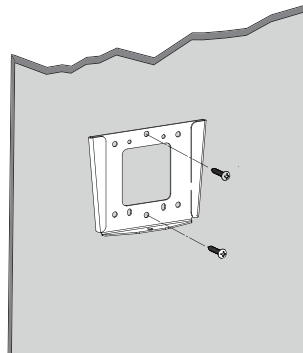

WARNING: Tighten screws so that the Wall Plate is firmly attached, but do not over tighten. Over tightening can damage the screws, greatly reducing their holding strength.

INSTALLING THE WALL PLATE (CONCRETE)

1. Place the wall plate against the wall in the desired location and level it. Mark the four, outer-most holes for securing the mount and set the wall plate aside.

WARNING: When installing Wall Arm Assembly on cinder block, verify first that you have a minimum of 1-3/8" of concrete thickness to be used for the Concrete Wall Anchors. Do not drill into mortar joints! Be sure to mount in a solid part of the block, generally 1" minimum from the side of the block. Cinder block must meet ASTM C-90 specifications. It is suggested that a standard electric drill on slow setting is used to drill the hole instead of a hammer drill to avoid breaking out the back of the hole when entering a void or cavity. Concrete must be 2000 psi density minimum. Lighter density concrete may not hold concrete anchor.

Make sure that the supporting surface will safely support the combined load of the equipment and all attached hardware and components.

2. Drill a 2-1/2" deep hole at marked locations using a 5/16" (8 mm) drill bit. Remove any excess dust from the holes.

3. Insert Concrete Wall Anchors into each hole so that its flush with the concrete surface. A hammer can be used to lightly tap the anchors into place if necessary.

NOTE: If the concrete wall is covered by a layer of plaster or drywall, the concrete anchor must pass completely through the layer to rest flush with the concrete surface.

4. Move the wall plate back into position and secure it using the Wood Screws from the hardware kit. Do not over-tighten these screws.

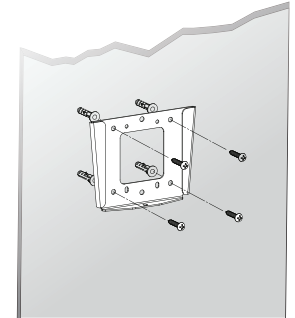

INSTALLING THE WALL PLATE ON DOUBLE GANG J-BOX (OR MUD-RING)

1. Place the wall plate against the J-Box. Line up the mounting holes of the wall plate with the holes in J-Box
2. Secure the wall plate to the J-Box using #6-32 x 1/2" Phillips Pan head mounting screws.

