



# **Commercial Stream Video Recorder**

## Installation Guide

ADC-CSVR2000P / ADC-CSVR2008P / ADC-CSVR2016P



# Pre-installation checklist

- Pro Series CSVR (included)
- A display with an HDMI input (optional)
- An HDMI cable (optional)
- AC power adapter (ADC-CSVR2000P)
- Power cord (ADC-CSVR2008P/ADC-CSVR2016P)
- An Ethernet Cat5e cable (included)
- USB Keyboard and Mouse (optional)
- Rack mount ears and screws (included, for rack installations)
- Dedicated network switch (recommended for ADC-CSVR2000P)
- Ethernet connection to broadband internet (Cable, DSL or Fiber Optic)
- An Alarm.com customer account with a service package that supports the Pro Series CSVR
- Login and password for the Alarm.com account to which you will add the Pro Series CSVR

\*The Alarm.com Pro Series CSVR is compliant with Section 889 of the NDAA and is not produced by any entity identified on the FCC's Covered List.

# Overview

- 1 Network LED
- 2 Status LED
- 3 Power LED
- 4 USB port
- 5 Power input
- 6 Power switch
- 7 HD Out ports
- 8 USB ports
- 9 Client RJ45 port
- 10 Camera RJ45 port
- 11 RJ45 PoE Ports

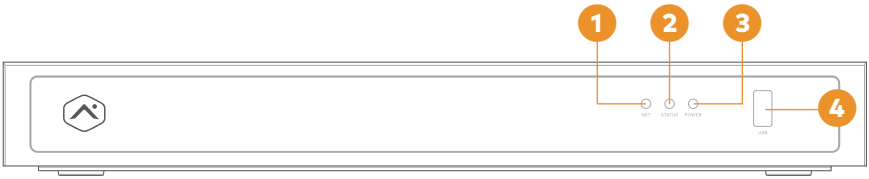

front (same on all devices)

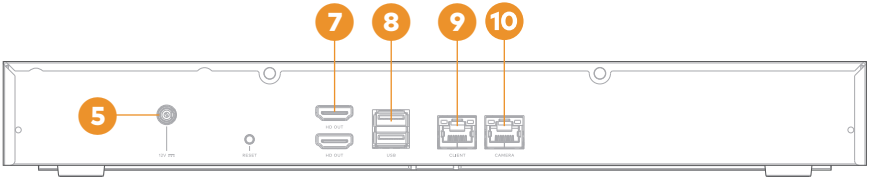

back (ADC-CSVR2000P)

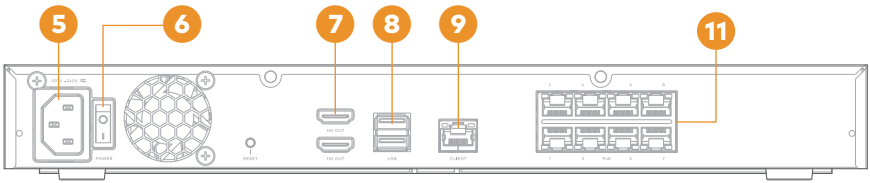

back (ADC-CSVR2008P)

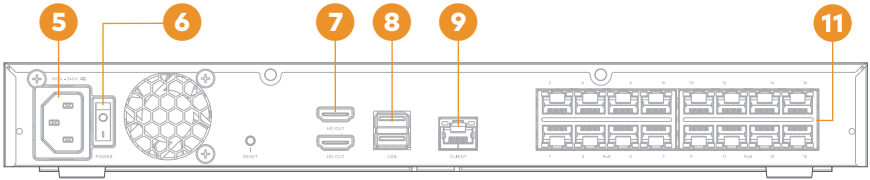

back (ADC-CSVR2016P)

# Recommended networking diagram for CSVR2000P

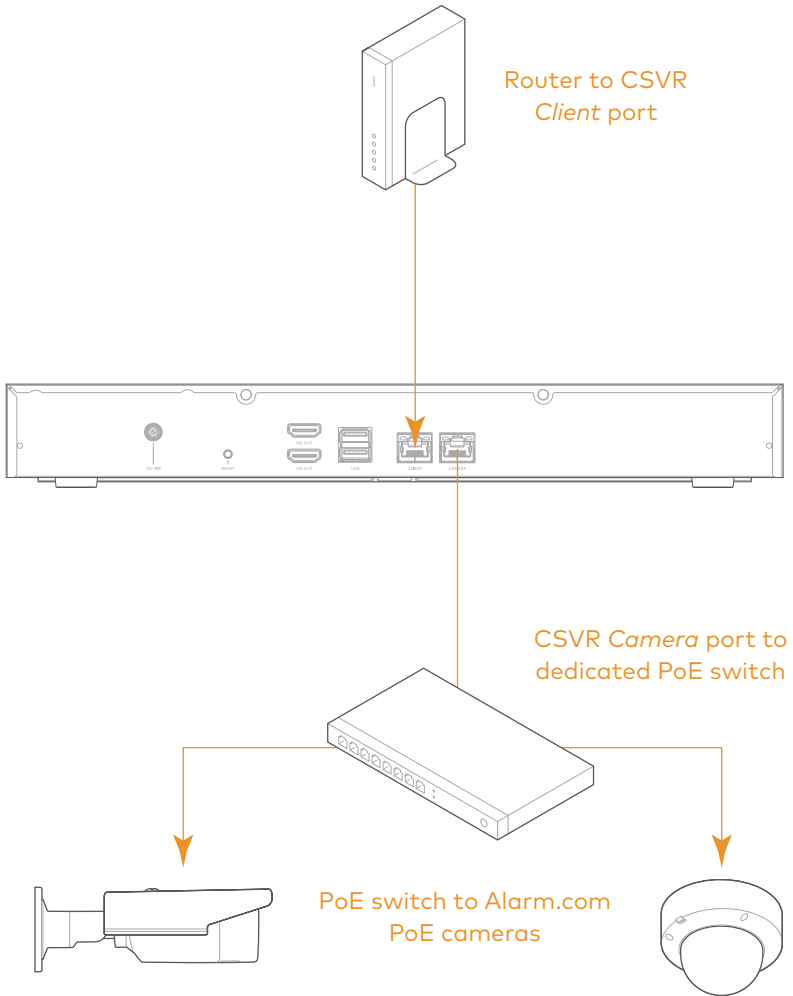

# Recommended networking diagram for CSVR2008P/CSVR2016P

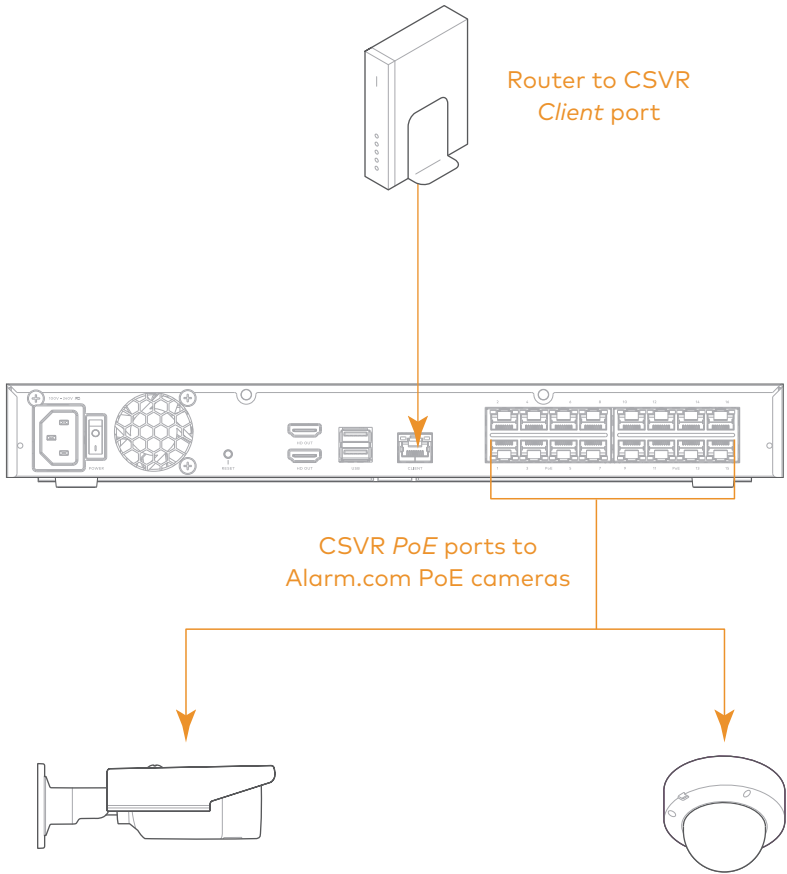

*Alarm.com recommends using our Pro Series PoE Cameras with the Pro Series CSVR.*

# LED guide

## Network LED



**Blinking green**  
*Client uplink active*



**Not illuminated**  
*Client uplink inactive*

## Power LED



**Solid green**  
*Powered on*



**Not illuminated**  
*Booting or powered off*

## Status LED



**Solid green**  
*Connected to Alarm.com*



**Blinking green**  
*Local network connection*



**Solid red**  
*No connection*



**Not illuminated**  
*Booting or powered off*



# Adding the device to an Alarm.com account

- 1 Using an Ethernet cable, connect the device to the network.
- 2 If you wish to use a display with your Pro Series CSV, please connect it to one of the *HD Out* ports using an HDMI cable.
- 3 Connect the device to a non-switched, grounded power outlet.
- 4 For the CSV2008P/CSV2016P: Use the switch on the back of the device to turn on your Pro Series CSV.
- 5 Wait for the device to boot up. A solid green status LED indicates that the device is ready to be added to the account. Please use one of the following methods:

## Customer Website

- a) Using a web browser, enter the following URL: **www.alarm.com/addcamera**. You will need the customer's username and password to log in to the Customer Website.
- b) Select the Pro Series CSV from the video device list or enter its MAC address to begin adding the device. The device's MAC address is located on the bottom of the device or on the packaging.
- c) Follow the on-screen instructions to finish adding the the Pro Series CSV.

## MobileTech installation

- a) Log in to MobileTech.
- b) Select the customer's account.
- c) Tap **Quick Actions > Add Device > Video**.
- d) Follow the on-screen instructions to finish adding the Pro Series CSV.

*You may associate cameras to the device and configure drives and display settings on the Customer Website or MobileTech.*

## Questions?

Visit **answers.alarm.com** or contact your service provider.

# Mounting the device to a rack

The CSV20xxP can be mounted to a standard server rack using the included rack mount kit. The rack mounts are designed to fit into a 1U (rack unit) area.

The kit includes the screws needed to attach the rack mount ears to the device, but does *not* include the screws needed to mount the device into a rack.

- 1 Gently pry off the rubber footpads from the bottom of the device.

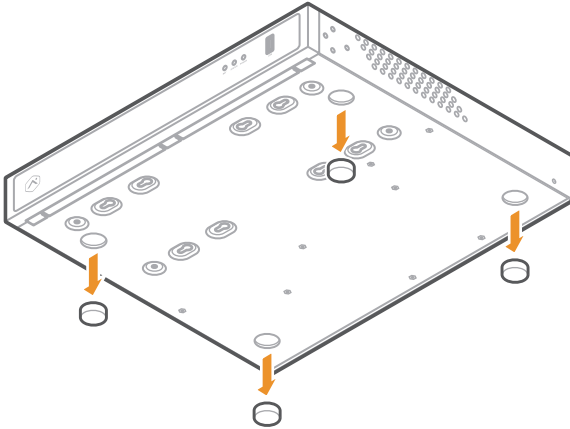

- 2 Using the included screws and brackets, attach a bracket to each side of the device.

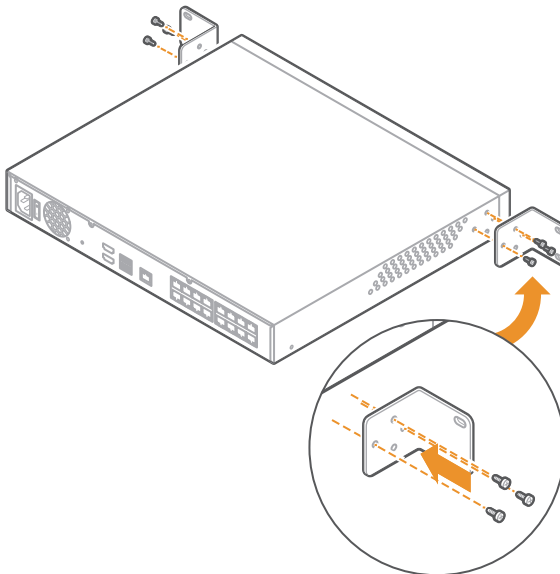

- Using server rack screws (not included), attach the brackets to each side of the server rack.

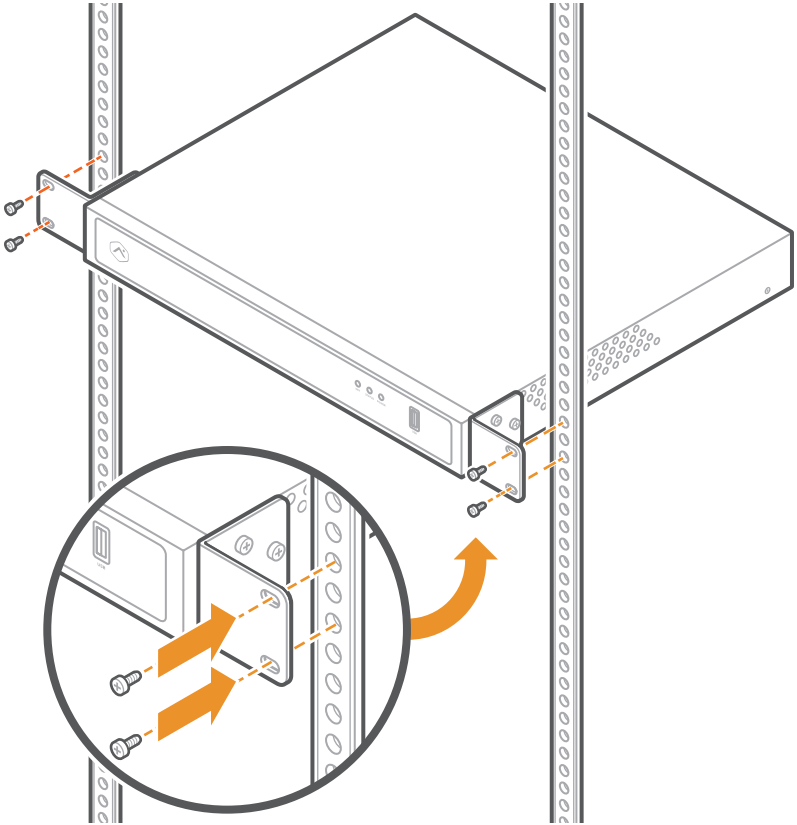

- Ensure that there is at least 10 in (25 cm) behind the device for proper airflow.

## Notices

Note: This equipment has been tested and found to comply with the limits for a Class A digital device, pursuant to part 15 of the FCC Rules. These limits are designed to provide reasonable protection against harmful interference when the equipment is operated in a commercial environment. This equipment generates, uses, and can radiate radio frequency energy and, if not installed and used in accordance with the instruction manual, may cause harmful interference to radio communications. Operation of this equipment in a residential area is likely to cause harmful interference in which case the user will be required to correct the interference at his own expense.

Rated:

- ADC-CSVR2000P - 12Vdc, 5A, 60W
- ADC-CSVR2008P - 100-240Vac, 60-50Hz, 3.5A, 200W
- ADC-CSVR2016P - 100-240Vac, 60-50Hz, 6-3A, 280W



The NVR is only to be connected to PoE networks without routing to outside plants.

- Ensure that all maintenance and repair work is handled by qualified personnel such as electrical engineers or network specialists.
- Connect the system to an earthed main power outlet.
- CAUTION: RISK OF EXPLOSION IF BATTERY IS REPLACED BY AN INCORRECT TYPE.  
DISPOSE OF USED BATTERIES ACCORDING TO THE INSTRUCTIONS.

IMPORTANT: The total power budget for the ADC-CSVR2008P POE ports is 120W, ADC-CSVR2016P POE ports is 200W. Every 8 ports (#1 – #8 or #9 – #16) provides 100W.

- The maximum output for each port is 30W. If a PoE device draws more than 30W, then PoE Power will be disabled on that port.

Changes or modifications not expressly approved by the party responsible for compliance could void the user's authority to operate this equipment.









8281 Greensboro Drive  
Suite 100  
Tysons, VA 22102

© 2021 Alarm.com. All rights reserved.  
210702 | Made in Taiwan