

# WIREFATH

## SURVEILLANCE



**WPS-750-DOM-IPH**

---

# IP DOME CAMERA



INSTALLATION MANUAL

*Review manual thoroughly before installation.  
Retain for future reference.*

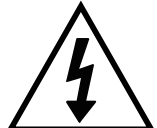

# 1. Safety Instructions

1. Read and follow all instructions and warnings in this manual. Keep for future reference.
2. Install according to manufacturer’s instructions.
3. Do not install near any heat sources such as radiators, heat registers, stoves or other apparatus (including amplifiers) that produce heat.
4. Only use attachments/accessories specified by the manufacturer.
5. Refer all servicing to qualified service personnel. Servicing is required when the apparatus has been damaged in any way, such as when the power-supply cord or plug is damaged, does not operate normally, or has been dropped.
6. THE MAINS PLUG OF THE POWER SUPPLY CORD SHALL REMAIN READILY OPERABLE.

 <p><b>CAUTION</b></p> <p><b>CAUTION: TO REDUCE THE RISK OF ELECTRICAL SHOCK.</b></p> <p><b>DO NOT REMOVE COVER. NO USER SERVICEABLE PARTS INSIDE.</b></p> <p><b>REFER SERVICING TO QUALIFIED SERVICE PERSONNEL.</b></p>		<p>The lightning flash with arrowhead symbol, within an equilateral triangle, is intended to alert the user to the presence of uninsulated dangerous voltage within the product’s enclosure that may be of sufficient magnitude to constitute a risk of electric shock to persons.</p>
		<p>The exclamation point within an equilateral triangle is intended to alert the user to the presence of important operating and maintenance (servicing) instructions in the literature accompanying the appliance.</p>

When viewing this document electronically, references to other sections are formatted to stand out. Click on a reference to navigate to the section. Table of Contents entries may also be clicked to link to sections for faster navigation.

Example: (Cross-reference in one section to another part of the manual) For more information see section [2. Introduction](#).

Example: (Hyperlink to a website, will open in a new browser window) Go to [www.SnapAV.com](http://www.SnapAV.com).



## Table of Contents

<b>1. Safety Instructions</b> .....	<b>2</b>
<b>2. Introduction</b> .....	<b>7</b>
<b>2.1. Features</b> .....	<b>7</b>
<b>3. Package Contents</b> .....	<b>8</b>
<b>4. Required Items for Installation</b> .....	<b>8</b>
<b>5. How It Works</b> .....	<b>9</b>
<b>6. Camera Connections</b> .....	<b>10</b>
<b>6.1. Network Cable Recommendation (PoE and non-PoE)</b> .....	<b>11</b>
<b>6.2. Choosing the Right Network Equipment</b> .....	<b>11</b>
<b>6.3. PoE Requirements- IEEE 802.3af</b> .....	<b>11</b>
<b>7. Camera Installation Instructions</b> .....	<b>12</b>
<b>7.1. Wiring Installation</b> .....	<b>12</b>
<b>7.2. Camera Mounting</b> .....	<b>12</b>
<b>7.3. Aiming the Camera</b> .....	<b>13</b>
<b>7.4. Focus, Zoom and Position</b> .....	<b>13</b>
<b>8.1. Network Software Setup - IP Installer</b> .....	<b>14</b>
<b>8.1.1. Running the IP Installer</b> .....	<b>14</b>
<b>8.2. IP Installer-Configuring Camera IP Settings</b> .....	<b>15</b>
<b>8.3. Verify Access through the Main Camera Interface</b> .....	<b>15</b>
<b>9. IP Camera Web Interface - Setup and Use</b> .....	<b>16</b>
<b>9.1. First Time Access Instructions</b> .....	<b>16</b>
<b>9.1.1. Recommendations for Best Web Viewing Performance</b> .....	<b>16</b>
<b>9.2. Camera Web Browser Interface</b> .....	<b>17</b>
<b>9.2.1. Web Interface Layout - Top Bar</b> .....	<b>17</b>
<b>9.2.2. Web Interface Layout - Bottom Bar</b> .....	<b>18</b>
<b>10. Camera Configuration Menu Setup</b> .....	<b>19</b>
<b>10.1. Configuration Menu - Access and Navigation</b> .....	<b>19</b>
<b>10.1.1. Accessing the Menu</b> .....	<b>19</b>
<b>10.1.2. Configuration Menu Layout</b> .....	<b>19</b>
<b>10.1.3. Configuration Menu Guidelines</b> .....	<b>19</b>
<b>10.2. System Information and Settings</b> .....	<b>20</b>



- 10.2.1. System Information Menu Settings**..... 20
  - 10.2.1.1. **Server Information**..... 20
  - 10.2.1.2. **OSD Setting**..... 20
  - 10.2.1.3. **Time Setting**..... 21
  - 10.2.1.4. **Network LED**..... 21
- 10.2.2. Camera Time Setup**..... 22
  - 10.2.2.1. **NTP Time**..... 22
  - 10.2.2.2. **Synchronize with PC’s Time**..... 22
  - 10.2.2.3. **Manual**..... 22
  - 10.2.2.4. **Internal Clock**..... 22
  - 10.2.2.5. **NTP Setup Instructions (For Cameras with Internet Access)**..... 23
  - 10.2.2.6. **Time Setup for Cameras without Internet Access**..... 23
- 10.2.3. User Management**..... 24
  - 10.2.3.1. **Anonymous User Login**..... 24
  - 10.2.3.2. **Add User (Guest Account only)**..... 24
  - 10.2.3.3. **User List**..... 24
  - 10.2.3.4. **User Account Levels**..... 24
  - 10.2.3.5. **Administrator Account Setup**..... 25
  - 10.2.3.6. **Add, Edit, or Remove a Guest Account**..... 25
- 10.2.4. System Update**..... 26
  - 10.2.4.1. **Firmware Upgrade**..... 26
  - 10.2.4.2. **Reboot System**..... 26
  - 10.2.4.3. **Setting Management**..... 26
  - 10.2.4.4. **How to Back up Camera Settings**..... 27
  - 10.2.4.5. **Load Backup Settings to the Camera**..... 27
  - 10.2.4.6. **Upgrade the Firmware**..... 28
- 10.3. Network IP Settings**..... 29
  - 10.3.1. Basic IP Settings**..... 29
    - 10.3.1.1. **IP Assignment**..... 29
    - 10.3.1.2. **Port Assignment**..... 30
    - 10.3.1.3. **UPnP**..... 30
    - 10.3.1.4. **RTSP Setting**..... 31
    - 10.3.1.5. **Multicast Setting (Based on RTSP Server)**..... 31
    - 10.3.1.6. **ONVIF**..... 32
    - 10.3.1.7. **Bonjour**..... 32
    - 10.3.1.8. **Link Layer Topological Discovery (LLTD)**..... 32
  - 10.3.2. Advanced IP Settings - HTTPS Access Setup**..... 33
    - 10.3.2.1. **Created Request**..... 33
    - 10.3.2.2. **Installed Certificate**..... 33
    - 10.3.2.3. **Connection Types**..... 33
  - 10.3.3. Advanced IP Settings - SNMP**..... 34
  - 10.3.4. Advanced IP Settings - Access List (IP Filter)**..... 35
    - 10.3.4.1. **IP Address Filter Setting**..... 35
    - 10.3.4.2. **Add or Remove IP Addresses or Ranges**..... 36
    - 10.3.4.3. **Controlling Administrator Access**..... 36
  - 10.3.5. Advanced IP Settings - QoS/DSCP**..... 37
    - 10.3.5.1. **QoS / DSCP Setting**..... 37



<b>10.3.6. PPPoE Setup</b> .....	<b>38</b>
10.3.6.1.    PPPoE Overview.....	38
10.3.6.2.    PPPoE Settings.....	38
10.3.6.3.    Send Mail after PPOE Dialed.....	38
<b>10.3.7. DDNS Setup</b> .....	<b>39</b>
10.3.7.1.    DDNS Overview.....	39
10.3.7.2.    DDNS Settings.....	39
10.3.7.3.    State (DDNS).....	39
10.3.7.4.    Setting Up a DDNS Address – WirepathDNS.....	40
<b>10.3.8. Server Settings</b> .....	<b>41</b>
10.3.8.1.    Email Notifications.....	41
10.3.8.2.    Mail Settings.....	41
10.3.8.3.    FTP Settings.....	42
10.3.8.4.    Network Share Settings.....	43
<b>10.4. Camera A/V Settings</b> .....	<b>44</b>
<b>10.4.1. Image Settings Menu</b> .....	<b>44</b>
10.4.1.1.    Tips for Getting the Best Camera Image.....	45
<b>10.4.2. How to Configure Day &amp; Night Settings (Color Modes)</b> .....	<b>46</b>
10.4.2.1.    Day & Night Modes.....	46
10.4.2.2.    Day & Night Modes.....	47
10.4.2.3.    Light Sensor Mode (Default Mode).....	47
10.4.2.4.    Day & Night Times Mode.....	47
10.4.2.5.    How to Configure Privacy Masks.....	48
<b>10.4.3. Video Settings Menu Overview</b> .....	<b>49</b>
10.4.3.1.    Video Setting (For BNC Test Adapter Output).....	49
10.4.3.2.    Streaming 1 and 2 Setting.....	49
10.4.3.3.    Streaming 3 (JPG/MJPEG).....	49
10.4.3.4.    Streaming 4 (3GPP).....	49
<b>10.4.4. Video Streaming 1 and 2 Setup</b> .....	<b>50</b>
<b>10.4.5. Streaming 3 and 4 Setup</b> .....	<b>52</b>
10.4.5.1.    Streaming 3.....	52
10.4.5.2.    Streaming 4.....	52
<b>10.4.6. Audio Settings</b> .....	<b>53</b>
<b>10.4.7. Camera Audio Technology Overview</b> .....	<b>54</b>
<b>10.5. Event Record Setup and Scheduling</b> .....	<b>55</b>
<b>10.5.1. Event Settings Menu</b> .....	<b>55</b>
10.5.1.1.    Record File.....	56
10.5.1.2.    Record Time Setting.....	56
10.5.1.3.    Network Disconnected.....	56
10.5.1.4.    Network IP Check.....	56
<b>10.5.2. Configuring Motion Detection Areas</b> .....	<b>57</b>
10.5.2.1.    Motion Detection Settings Overview.....	57
10.5.2.2.    Adding a New Motion Detection Area.....	58
10.5.2.3.    Removing a Motion Detection Area.....	58
<b>10.5.3. Schedule Menu</b> .....	<b>59</b>



10.5.3.1.	Snapshot Menu.....	59
10.5.3.2.	How to Set Up Scheduling for Events.....	60
10.5.3.3.	Set up Snapshot.....	60
10.5.4.	I/O Settings.....	61
10.5.4.1.	Input Settings.....	61
10.5.4.2.	Output Settings.....	61
10.6.	Log List.....	62
10.6.4.1.	Motion Detection Log.....	62
10.6.4.2.	All Logs.....	62
10.7.	SD Card Menu.....	63
10.7.1.	Playback.....	63
10.7.2.	SD Management.....	63
11.	Internal Heater Overview.....	64
11.1.	Safe Operating Range.....	64
12.	Reset Procedure.....	65
13.	Mobile App Access.....	65
14.	Specifications.....	66
15.	Dimensions.....	68
16.	Warranty.....	69
17.	Contacting Technical Support.....	69



## 2. Introduction

Thank you for purchasing a Wirepath™ IP Surveillance camera. The WPS-750-DOM-IPH is an indoor/outdoor camera designed for mounting to any wall, ceiling or surface, for easy monitoring over a web or smartphone interface.

We recommend that this document be read in its entirety before proceeding with system design, installation, or operation of the camera.

### 2.1. Features

- **1/2.7" 2MP CMOS Sensor**  
Advanced CMOS sensor provides improved picture quality over a typical CCD sensor. Supports full 1080p HD (1920x1080) at 30FPS.
- **Varifocal Lens**  
This camera features a varifocal lens with a focal length of 2.8-12 mm.
- **H.264/ MJPEG Quadruple Stream Optimization**  
Supports up to 4 simultaneous streams of compression typically used for the following situations:
  - High Res stream optimized for NVR Record or Local Network viewing
  - Lower Res stream optimized for Remote viewing
  - Lower Res stream optimized for Control Systems (same res as Stream 2)
  - Low Res stream for Mobile Viewing
- **Low Temperature Operation**  
A heater is included that automatically turns on and off to ensure the camera operates within an optimum temperature range, and helps to minimize condensation inside the housing at low temperatures. The heater activates automatically at 40°F and deactivates at 55°F.
- **IR up to 50 ft**
- **True Day/Night (IR Cut Filter)**  
For more accurate, vivid color reproduction during daytime use, an IR Cut filter is automatically moved over the lens to block unwanted IR. At night, the filter is removed to deliver maximum visibility and clear IR illumination.
- **Advanced Image Processing**  
Advanced DSP (Digital Signal Processor) to improve image quality including:
  - **Sense Up:** Automatically slows the shutter speed to improve image quality in low light.
  - **D-WDR (Digital Wide Dynamic Range):** Provides clearer images and even lighting in applications that are simultaneously bright and dark. This is particularly useful in areas with windows and lots of natural light.
  - **2D and 3D Digital Noise Reduction (DNR):** Intelligently scans the image and reduces noise in low-lux conditions for a cleaner, crisper image.
- **Privacy Mask**  
Block out sensitive or privileged areas by placing rectangular blocks or "masks" over up to three installer-defined areas.
- **Power Over Ethernet (PoE IEEE 802.3af)**  
Camera can be powered by PoE using the same Cat5e/Cat6 cable that connects to the network. No need to pull a 2nd power cable to the location. Compatible with all PoE network switches that support PoE IEEE 802.3af and PoE power injectors.
- **Edge Storage**  
The camera supports microSD cards (up to 32GB, card NOT included). Images, short recordings and logs can be stored on a microSD installed into the camera. This is useful as a backup if the network connection to the NVR is lost.
- **Test Port for Quick Setup during Install**
  - Analog Video Out
  - Local 12V DC Power for Camera
- **IP-66 Weatherproof Rating**  
With an IP-66 rating, this camera is protected from dust and water making it effective for indoor and outdoor installations.
- **ONVIF**



### 3. Package Contents

- (1) WPS-750-DOM-IPH Camera
- (1) WPS-ACC-PWR Power Adapter
- (1) Female to Female RJ45 Adapter
- (1) 3mm Allen Key
- (4) Screws
- (4) Wall Fasteners
- (1) Spare Silica Pack
- (1) Quick Start Guide

**NOTE: A POWER SUPPLY IS NOT INCLUDED WITH THIS CAMERA.** The PS-12DC-1A, WPS-PS multiple output power supply or a Power over Ethernet (PoE) switch is recommended.

### 4. Required Items for Installation

The following items are required during the installation of a Wirepath™ IP camera. Prepare all parts and tools in advance to ensure that the installation can be performed smoothly.

- **Local Ethernet network installed**
- **All cameras to be installed in the system**
- **PoE Ethernet equipment or power supplies and wiring to power cameras**
- **Network connection at each camera location**
- **Access to a PC connected to the local network**
- **Static IP address to assign to the camera**
- **Additional access information for network equipment:**
  - Router / Switch Details – Contact the network admin to obtain access to equipment settings
  - Admin Rights – Required to setup the network and port forwarding for remote access
  - Default Gateway
  - Subnet Mask
  - DNS Address
- **Recommended for mounting cameras and wiring:**
  - Hand tools
  - Drill (may be needed for mounting the camera)
  - Extra connectors for terminating cables on the job





## 5. How It Works

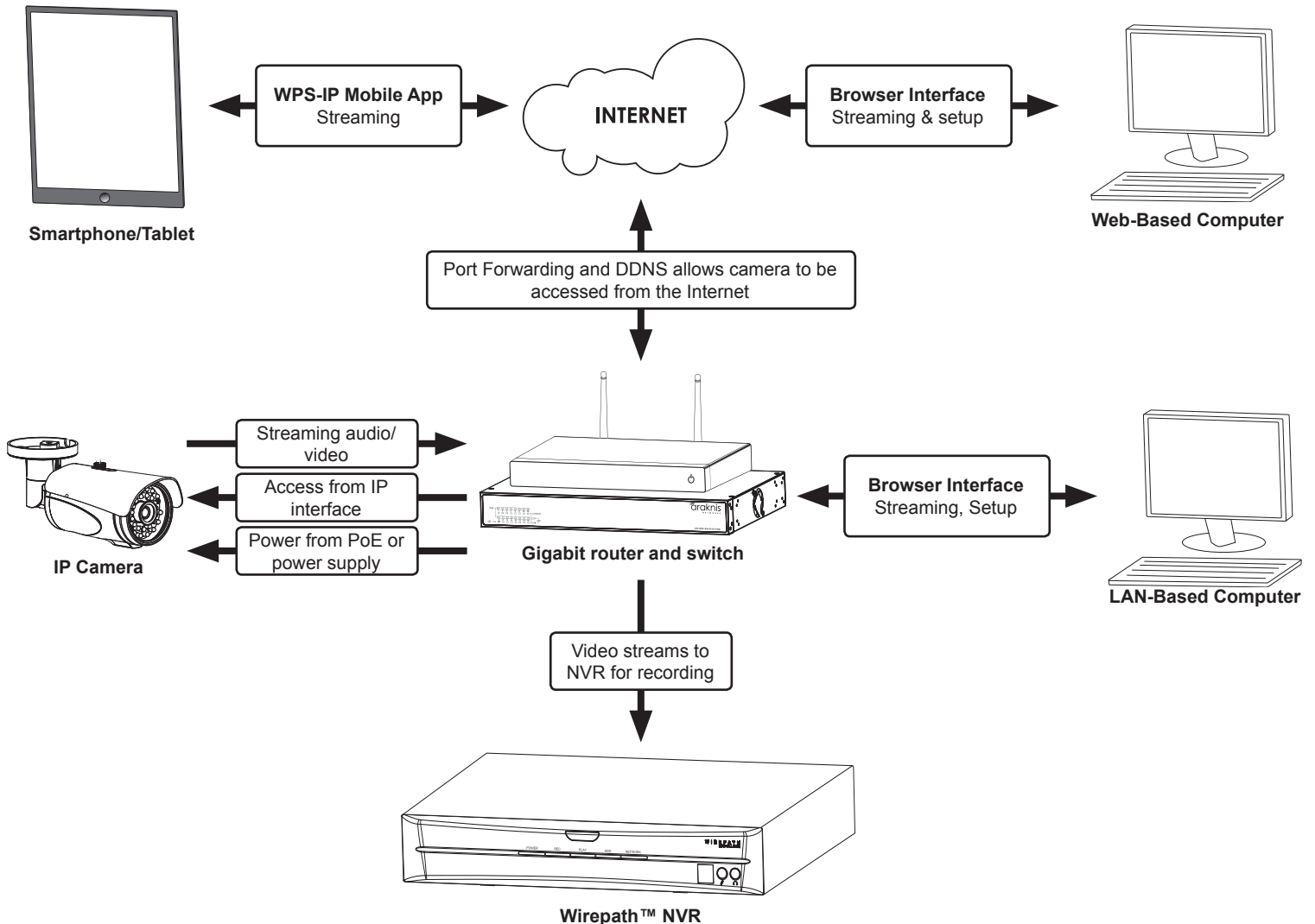

### How Does IP Video Surveillance Work?

Wirepath™ IP cameras use a digital image processor to capture video in a stream of packets that are broadcast using a standard Ethernet network. These packets can be received by several devices at once, including local PCs, mobile devices, and recorders (NVRs) on the same network, or even off the network (with the correct setup and web access).

Users can see the camera feed through the interface of their choice, or see recorded footage from a storage device like an NVR. Wirepath Surveillance offers apps for iOS® devices, Android® smartphones, Windows PC, and Mac computers. Drivers for various popular control systems are also available for integration with a control system.

### Access and Use

For local network (LAN) access, a static IP address is assigned to the camera in the network router. The user enters this address into a PC, smartphone, or other device connected to the LAN, and logs in using a customizable username and password.

For access outside the LAN, a port is forwarded to the camera in the network router settings and a DDNS address is set up in the camera. This enables the same streams from the camera to be broadcast anywhere in the world over an Internet connection.

In systems where the camera stream must be recorded, a network video recorder (NVR) is connected to the LAN. The address and login credentials for the camera are entered and the stream can be captured as needed for later viewing.



## 6. Camera Connections

Wirepath™ Surveillance IP Cameras can be powered by Power over Ethernet (PoE) through the Cat5e/Cat6 Ethernet connection. This method is recommended because it limits the amount of wiring required, reducing installation cost and time. The camera must be connected to a compatible PoE-equipped router/switch or a PoE injector for this method to work.

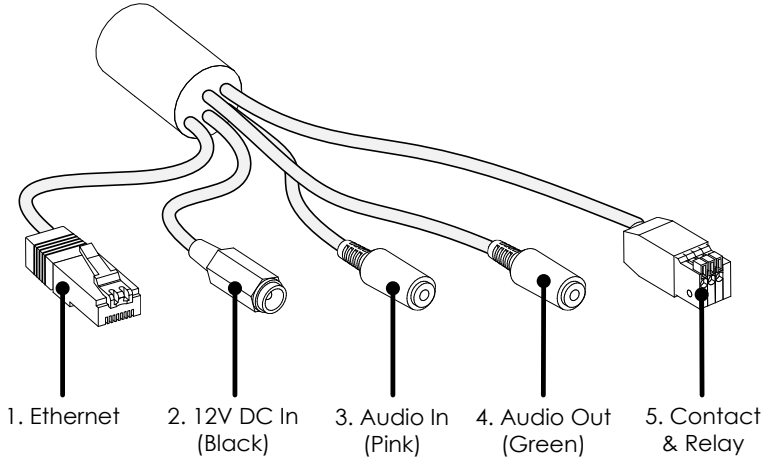

### 7. Ethernet Connection (RJ45)

Connect to network switch for communication to and from the camera. Pin out follows EIA standard 568-B.

### 8. 12V DC Power In (Barrel Connector)

Connect to a 12V DC power supply. The camera is not supplied with a power supply. No power supply is needed if PoE is being used to power the camera via the Ethernet connection.

**Warning!** Use only a 12V DC power supply with this camera. Higher voltages or AC current will cause permanent damage that is not covered by the warranty.

### 9. Audio In (1/8" / 3.5mm Stereo)

Connect a microphone to receive audio at the cameras location.

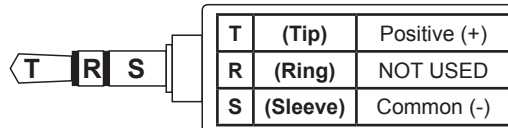

### 10. Audio Out (1/8" / 3.5mm Stereo)

Connect to an amplifier and speakers to allow for communication between the viewer and the cameras location.

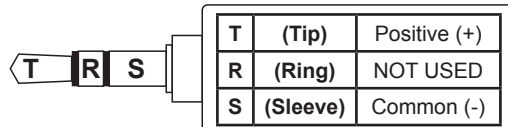

### 11. Contact & Relay (Spring Loaded Terminal)

Connect to devices with contact closure output to trigger recording, or activate devices like lights or sirens at the camera location.

DO	(Output)	Switched
GND	(Ground)	Common (-)
DI	(Input)	Contact

DO — Max +5V DC 50mA



## 6.1. Network Cable Recommendation (PoE and non-PoE)

- **Cable Type:** Cat5e/6
- **Max Length:** 100 meters (328 feet)
- **Termination:** 568B recommended

TIA/EIA Standard 568-B (Gold Pins Facing Up)

Pin 1	White/Orange	Pin 5	White/Blue
Pin 2	Orange	Pin 6	Green
Pin 3	White/Green	Pin 7	White/Brown
Pin 4	Blue	Pin 8	Brown



## 6.2. Choosing the Right Network Equipment

Streaming content from IP Cameras requires more bandwidth than most IP devices. We recommend using 1Gbps routers and switches to maintain a high quality streaming image. To reduce traffic on the overall network, we also recommend that all IP Surveillance devices be connected to a dedicated 1Gbps switch or VLAN.

## 6.3. PoE Requirements- IEEE 802.3af

Cameras must be connected to a PoE injector (inline PoE power supply) or a PoE-equipped port of a network router or switch built to IEEE 802.3af standards. Consider installing a dedicated PoE switch specifically for IP cameras on the network to avoid issues relating to power shortage.

- **Minimum requirement for PoE ports:**
  - **Voltage:** 44V DC
  - **Wattage:** 15.4W
  - **Amperage:** 350mA



## 7. Camera Installation Instructions

### 7.1. Wiring Installation

- A. Run a Cat5e/6 cable from the network port to the camera location and terminate both ends to 568B.
- B. (Non-PoE applications only) Run wiring to the camera from the power supply location. Use the voltage drop calculator at [www.SnapAV.com](http://www.SnapAV.com) to determine the wire size needed.
- C. (Non-PoE applications only) Connect the power supply to the wire at the head end using electrical connectors (not included), and attach the WPS-ACC-PWR-M to the wire at the camera location. Be sure to use the correct polarity.
- D. (Non-PoE applications only) Connect the power supply to a suitable outlet and test the voltage at the camera side of the wire using a volt meter. Disconnect the power supply from the outlet until camera installation is otherwise complete.

### 7.2. Camera Mounting

**Important Note:** To avoid damaging the dome surface during installation, keep the dome surface away from walls and other objects. Do not remove the protective film from the dome until after the camera is mounted and the dome installed.

- A. Unpack the camera and open the dome. Do not remove the protective film from the dome.
- B. If the camera is going to be surface-mounted, use the provided foam gasket as a template to mark 3 mounting hole locations, and then make pilot holes for the screws. If a mounting accessory is being used, install the accessory over the wiring according to the included instructions.
- C. Attach the foam gasket to the bottom of the camera base. Pull the cable through the side of the housing knockout if needed.
- D. Connect the wiring to the camera, then push the wiring into the box or cavity behind the camera.
- E. Secure the camera to the accessory or surface using 3 screws.
- F. Install a microSD card in the slot if desired.
- G. Pull the test adapter from inside the dome housing if needed for attaching a test monitor and power supply.

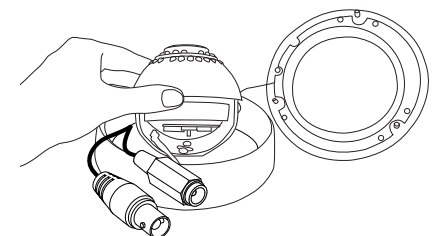
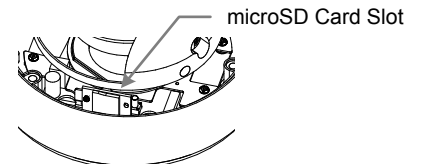
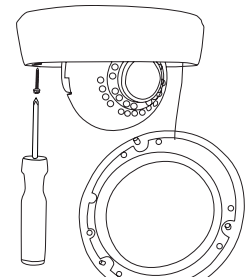
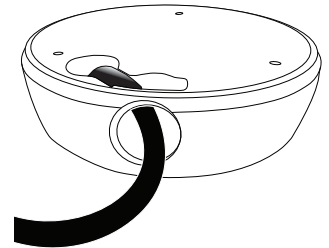
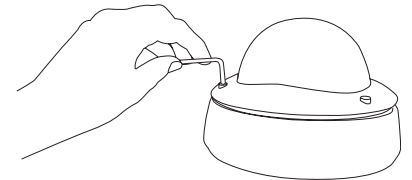



### 7.3. Aiming the Camera

- Connect the BNC Test Adapter to a monitor or WPS-CCTV-TESTER video in.
- Connect a power supply to the secondary power connection on the camera (if main power connection is not active).
- Adjust the camera's 3-axis angle so the lens points in the desired direction.

**Warning:** The lens angle must not exceed  $67^\circ$  off the center axis. This will prevent IR reflection inside the dome from causing a halo effect in the camera image at night.

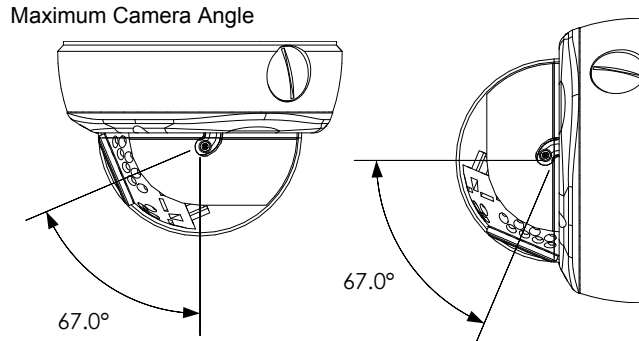

### 7.4. Focus, Zoom and Position

The lens of the camera has manual focus and zoom knobs for setting the correct field of view and the gimbal may be rotated for tilt correction. Connect the test adapter as described below to use a monitor at the camera location for viewing adjustments.

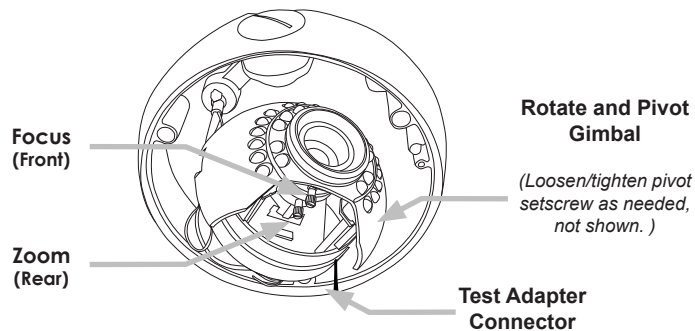

Disconnect the WPS-CCTV-TESTER or monitor and power supply from the local test connections and push them back into the housing.

### Closing the Camera Dome

**Recommendation:** Before replacing the dome we recommend that a new silica gel pack be inserted into the camera to ensure that any moisture present will be removed.

- Ensure that the lens gasket is properly fitted to the lens assembly.
- Replace the dome cover to the dome base, and make sure the screws on the dome cover are tightened securely.
- Remove the warning sticker and protective film.

**Warning:** The dome must provide a tight fit around the rubber lens gasket to avoid IR reflection off of the dome resulting in a halo effect in the camera image at night.

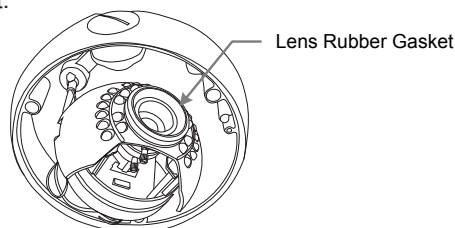



## 8.1. Network Software Setup - IP Installer

The IP Installer software included with the camera provides a quick view of Wirepath™ IP Surveillance devices connected to the local network. Use the Installer to search for and set basic IP settings for each camera.

Before starting any configuration or service of Wirepath™ IP devices, we recommend checking for a newer version of the IP Installer on the camera's support tab at [www.SnapAV.com](http://www.SnapAV.com).

**Important! Active VPN connections anywhere on the network will prevent the IP Installer from working correctly. Close all VPN connections before running the Installer.**

**Device List** displays connected devices on the network.

Click a device name to make changes in the right column.

Double-click a device name to load the IP interface using your web browser.

Click **Search Device** to refresh the Device List.

Server Name	IP Address
NVR 4CH	192.168.001.070
frontdoor	192.168.001.075
IP_Camera	192.168.001.073

Static  
 DHCP

Name: IP\_Camera  
 IP: 192 168 1 73  
 Netmask: 255 255 255 0  
 Gateway: 192 168 1 1  
 DNS 1: 192 168 1 1  
 DNS 2: 172 30 52 13  
 Port1: 80  
 MAC: D4:6A:91:11:00:8F

**To Change Device Name, IP address, and Gateway:**  
 1. Select the device on the left side.  
 2. Change network parameter on the right side.  
 3. Press Submit button.  
 4. Press Search Device to re-search again.  
 5. Double click the device to open it.

**Right column** shows current IP settings for the highlighted device.

Change settings by updating the fields and then clicking **Submit**.

### 8.1.1. Running the IP Installer

- The IP Installer EXE file can be downloaded from the camera's support tab at [www.SnapAV.com](http://www.SnapAV.com). No installation is required for use. Extract the file from the ZIP file (if compressed) and move it to the Desktop or folder of your choice.
- Run the software. Windows may attempt to block the action. If this occurs, allow the software to run. No changes will be made to Windows or other system files. It may be necessary to log in as or provide the administrator account password for the PC for the IP Installer to run.
- When it opens, the installer automatically scans the network for any connected Wirepath™ IP Cameras, NVRs, and Encoders. Click **Search Devices** to rescan the network if more devices are added and make changes to camera settings as needed.
- Click the **X** at the top right corner or the **Exit** button to close the IP installer when all devices are configured. Windows may display an error that the software did not install correctly when it closes but this should be disregarded.



## 8.2. IP Installer-Configuring Camera IP Settings

By default, the camera will receive a DHCP IP address. This should be changed to a reserved or static IP address so that the camera remains accessible after setup. Obtain the settings below from the network administrator before installation.

IP Installer V3.0

Device lists:

Server Name	IP Address
NVR 4CH	192.168.001.070
frontdoor	192.168.001.075
IP_Camera	192.168.001.073

Static  
 DHCP

Name: IP\_Camera

IP: 192 168 1 73

Netmask: 255 255 255 0

Gateway: 192 168 1 1

DNS 1: 192 168 1 1

DNS 2: 172 30 52 13

Port1: 80

MAC: D4:6A:91:11:00:8F

Search Device      Submit

Exit

To Change Device Name, IP address, and Gateway:  
 1. Select the device on the left side.  
 2. Change network parameter on the right side.  
 3. Press Submit button.  
 4. Press Search Device to re-search again.  
 5. Double click the device to open it.

Consult with the router manufacturer for instructions to correctly set up a reserved or static IP address.

- Open the IP Installer and single-click on a camera in the Device List. Its current settings will appear in the right column fields.
- Select **“Static”** at the top of the right column. Network settings may now be modified.
- Assign a name to the camera based on the scene or location (limited to 31 characters) Examples: FrontDoor1, SideDoor...
- Enter the reserved static IP address for the camera.
- Enter the Net Mask (usually 255.255.255.0).
- Enter the default Gateway (found in the router).
- Enter the DNS 1 address (found in the router).
- Enter the DNS 2 address (found in the router). **Set DNS 2 “0.0.0.0” if no DNS 2 is set in the router.**
- Enter a unique port number to enable remote Internet access to the camera. Use port numbering that is consistent and easy to remember. We recommend using 4 digits, “8” followed by the last three numbers of the camera’s IP address.

**Examples:**

Camera	IP Address	Port
Patio	192.168.1.050	8050
Front Door	192.168.1.100	8051

## 8.3. Verify Access through the Main Camera Interface

Once the IP address has been set, the camera can be accessed through the web browser. Note that on initial access to each camera, Active X controls will need to be installed on each PC that is used to access the camera. Continue to the next section for web browser access and setup.



## 9. IP Camera Web Interface - Setup and Use

### 9.1. First Time Access Instructions

- A. Connect the PC to the same local network (LAN) the camera is connected to.
- B. Open the web browser and enter the IP address that was assigned to the camera. The address should include the port number assigned to the camera if one was set. See the example:

- **IP Address using default port:** http://192.168.1.015
- **IP Address using port 8015:** http://192.168.1.015:8015

You may also access the web interface from the WPS-IP Installer software by double-clicking a camera in the device list.

- C. A dialog box will open asking for a username and password. Default settings:

- **Username:** admin
- **Password:** admin

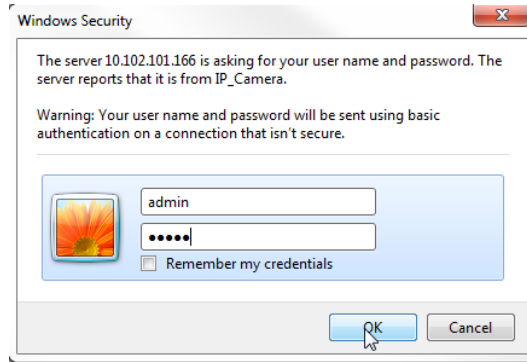

#### 9.1.1. Recommendations for Best Web Viewing Performance

- As the number of open browser windows or tabs increases, the risk of slowed response time to the cameras increases. Avoid keeping more than four separate browser windows open that are connected to cameras.
- Depending on the speed of the network and the Internet connection at the installation, it may be necessary to change video streaming settings. If access is regularly interrupted or very slow, see section [10.4.4. Video Streaming 1 and 2 Setup](#) to optimize these settings.





## 9.2. Camera Web Browser Interface

The web browser Home screen displays video and current information from the camera feed. The camera name, time signature, video frame size and frames per second (FPS) being streamed are all displayed by default. Use the drop-down menus and buttons to interact with the cameras inputs and outputs, change the stream, or enter the setup menus.

### 9.2.1. Web Interface Layout - Top Bar

(Buttons are enlarged for reference)



#### 1. Video (Full-screen Mode)

Click to expand the view to full-screen mode. Press the Escape key or double-click the full-screen image to return to the standard Live View screen.

#### 2. Zoom (Digital Zoom Window)

Clicking Digital Zoom opens the Digital Zoom window. Use the slider to magnify the camera view to a small area of the screen.

The Live View will only remain at this zoom level and area selection for the current viewing session. When the user leaves Live View, the zoom level resets to 100%.

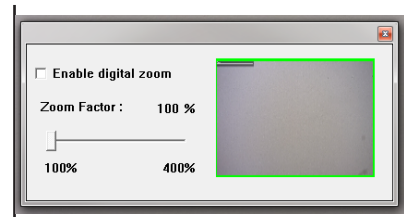

#### 3. Audio Out

Click to toggle audio to the built-in speaker/Audio Out port on or off.

#### 4. Audio In

Click to toggle the camera microphone on and off.

#### 5. Record

Record the current live stream to an .AVI video file that is saved to the PC or a network drive. A window opens for selecting the storage location each time recording is started. Press Record again to stop the recording. The quality of this recording will vary based on the bandwidth of the connection to the camera and the processing power of the local computer.

#### 6. Photo

Takes a JPEG snapshot of the current image that can be saved to the PC or a network drive.

#### 7. Config

Click to enter the Configuration menus. All network and camera settings are configured in this menu. You must be logged in with administrator privileges to access the Configuration Menu.



## 9.2.2. Web Interface Layout - Bottom Bar



- 1. Information Bar**  
Displays basic information about the camera feed.
- 2. Video Size**  
Adjusts the size of the Live View area within the browser window.
- 3. Video Source (If Streaming 2 is enabled)**  
Allows for selection of one of two video streams from the camera. Typically, Streaming 1 is configured for a high resolution stream for viewing over a faster connection, and Streaming 2 is to a lower resolution for viewing over slower connections. See section [10.4.3. Video Settings Menu Overview](#) for information about streaming features and setup.
- 4. Online Visitors**  
Displays the number of users (all permission levels) currently logged in to view the camera. If anonymous viewing is allowed, all anonymous viewers will also be counted. If you are the only user, then the number will be 1, unless an NVR is attached, which will add 2 users to the count.
- 5. Closed/Open Buttons**  
Click the buttons to toggle the built-in relay on the camera.



## 10. Camera Configuration Menu Setup

After browser access to the camera has been established, the remaining steps for setup may be completed so that cameras are remotely viewable (from inside and outside of the LAN) but secure from unwanted access.

### 10.1. Configuration Menu - Access and Navigation

#### 10.1.1. Accessing the Menu

To change settings in the cameras, click the “Config” button in the top right corner of the Live View screen.

**Important! If you click “Config” while logged in under a guest account (any account except the root “admin” account) you will be prompted for a log in. You must enter the “admin” credentials to access the menu.**

#### 10.1.2. Configuration Menu Layout

The left column of the Configuration menu screen contains the navigation links for all Configuration sub-menus. The first sub-menu, System Information, appears by default:

The screenshot displays the camera's configuration interface. On the left is a dark sidebar with navigation icons and labels: System (System Information, User Management, System Update), Network (IP Settings, Advanced, PPPoE & DDNS, Server Settings), A/V Setting (Image Settings, Video Settings, Audio Settings), and Event (Event Settings, Schedule, I/O Settings, Log List, SD Card). The main content area is titled 'System Information' and contains several sections:

- Server Information:** MAC Address (D4:6A:91:11:00:8F), Server Name (IP\_Camera), Status Bar (checked), and Language (English selected, others: 繁體中文, 简体中文, French, Russian, Italian, Spanish, German, Portuguese, Polish, Japanese).
- OSD Setting:** Time Stamp (Enabled selected, Disabled), Position (Bottom-Left selected, others: Top-Left, Top-Right, Bottom-Right), Text (Disabled selected, Enabled), and an OSD\_Display button with a Text Edit option.
- Time Setting:** Server Time (07/01/2014 3:47:50 P.M. Time Zone: GMT-05:00), Date Format (mm/dd/yy selected, others: yy/mm/dd, dd/mm/yy), Time Format (12-Hour selected, 24-Hour), Time Zone (GMT-05:00), and an Enable Daylight Saving checkbox.
- Daylight Saving Details:** DST Start (Mar 2nd Sun 2:00 AM), DST End (Nov 1st Sun 2:00 AM).
- NTP:** NTP Server (pool.ntp.org), Update (6 Hour), Time Shift (0 Minutes [-1440..1440]).
- Synchronize with PC's time:** Date (07/01/2014), Time (3:47:54 P.M.).
- Manual:** Date (07/01/2014), Time (3:41:18 P.M.).
- Internal Clock:** (Unselected).
- Network LED:** Network LED (Disabled selected, Enabled).

An 'Apply' button is located at the bottom right of the configuration area.

#### 10.1.3. Configuration Menu Guidelines

- When changing settings, some values will be saved automatically. Others require that an “Apply” button be clicked to save the change. Navigating away from pages with an “Apply” button without saving will cause settings to revert. Be sure to scroll down to the bottom of any menu before navigating away to check for an option to apply the setting, or refer to the manual.



## 10.2. System Information and Settings

### 10.2.1. System Information Menu Settings

- Navigation: Log in as an administrator. From Home Screen, click “Config” button in top right corner.

The screenshot shows the 'System Information' configuration page. The left sidebar contains navigation menus for System, Network, A/V Setting, and Event. The main content area is titled 'System Information' and is divided into four numbered sections:

- Server Information:** Includes fields for MAC Address (D4:6A:91:11:00:8F), Server Name (IP\_Camera), Language (English, 繁體中文, 简体中文, French, Russian, Italian, Spanish, German, Portuguese, Polish, Japanese), and a Status Bar checkbox.
- OSD Setting:** Includes Time Stamp (Enabled/Disabled), Position (Top-Left, Top-Right, Bottom-Left, Bottom-Right), and Text (Enabled/Disabled) options. There are buttons for 'OSD Display' and 'Text Edit'.
- Time Setting:** Includes Server Time (07/01/2014 3:47:50 P.M.), Date Format (yy/mm/dd, mm/dd/yy, dd/mm/yy), Time Format (24-Hour, 12-Hour), Time Zone (GMT-05:00), and an 'Enable Daylight Saving' section with DST Start/End, Day of Week, and Time settings. It also has NTP and Manual time synchronization options.
- Network LED:** Includes a Network LED checkbox (Enabled/Disabled).

An 'Apply' button is located at the bottom right of the configuration area.

#### 10.2.1.1. Server Information

<b>1</b>	<b>MAC Address</b>	Cannot be changed. Use the MAC address to identify a camera if IP settings have been lost.
	<b>Server Name</b>	Modify the name given to the camera during IP Installer Setup. (Limited to 31 characters)
	<b>Language</b>	Select the desired language for camera software text.
	<b>Status Bar</b>	(Check box option to right of Server Name field) Check to display the status bar in the camera image.
Click “Apply” at the bottom right of the page to save modified settings.		

#### 10.2.1.2. OSD Setting

<b>2</b>	<b>Time Stamp</b>	Select whether the camera’s time and date information are recorded and transmitted with video.
	<b>Position</b>	(If Time Stamp is enabled) Select where the OSD stamp text and system information appears.
	<b>OSD_Display</b>	Click the Text Edit button to enter OSD_Display Text Editor:
	<b>Text</b>	Enter text to be displayed beside the System Time and Date.
	<b>Size</b>	Set the point size of the OSD text using the drop-down.
	<b>Transparency</b>	Set the transparency of the OSD text to be more or less visible.
Click “Apply” at the bottom right of the page to save modified settings.		



### 10.2.1.3. Time Setting

**3** Time Setting

Server Time: 07/01/2014 3:47:50 P.M. Time Zone: GMT-05:00

Date Format:  yy/mm/dd  mm/dd/yy  dd/mm/yy

Time Format:  24-Hour  12-Hour

Time Zone: GMT-05:00

Enable Daylight Saving:

DST Start:	Month	Day of Week	Time
DST Start:	Mar	2nd	2:00 AM
DST End:	Nov	1st	2:00 AM

NTP :

NTP Server : pool.ntp.org

Update : 6 Hour

Time Shift : 0 Minutes [-1440..1440]

Synchronize with PC's time

Date : 07/01/2014

Time : 3:47:51 P.M.

Manual

Date : 07/01/2014

Time : 3:44:18 P.M.

Internal Clock

**4** Network LED

Network LED:  Enabled  Disabled

Apply

<b>3</b>	<b>Server Time</b>	Current time based on the settings saved in the camera.
	<b>Date Format</b>	Select the order in which days (d), months (m), and years (y) are displayed.
	<b>Time Zone</b>	(Only available for NTP and Manual mode) Set the camera time zone in hours ahead of or behind Greenwich Mean Time (GMT).
	<b>Enable Daylight Savings Time</b>	Check to enable Daylight Savings Time Settings. When this setting is enabled, DST start and end times may be set. Default times are standard for most participating regions.
	Time setup options are detailed in section <a href="#">10.2.2. Camera Time Setup</a> .	
	Click "Apply" at the bottom right of the page to save modified settings.	

### 10.2.1.4. Network LED

- 4** Enable or disable the network status lights on the RJ45 connector (back of the camera) The LEDs are useful for setup and diagnostics, but may cause unwanted color reflections behind the camera during regular use.



## 10.2.2. Camera Time Setup

**Important! Wirepath™ Surveillance strongly recommends using the “NTP” time setting option unless Internet access is not available from the camera network. Other settings may not keep the correct time after power outages or other failures.**

The screenshot shows the 'Time Setting' configuration page. On the left is a navigation menu with options like AV Setting, Audio Settings, Event Settings, Schedule, I/O Settings, Log List, and SD Card. The main area is titled 'Time Setting' and shows the following settings:

- Server Time: 07/01/2014 3:47:50 P.M. Time Zone: GMT-05:00
- Date Format:  yy/mm/dd  mm/dd/yy  dd/mm/yy
- Time Format:  24-Hour  12-Hour
- Time Zone: GMT-05:00
- Enable Daylight Saving:
  - DST Start: Mar 2nd Sun 2:00 AM
  - DST End: Nov 1st Sun 2:00 AM
- NTP:
  - NTP Server: pool.ntp.org
  - Update: 6 Hour
  - Time Shift: 0 Minutes [-1440..1440]
- Synchronize with PC's time:
  - Date: 07/01/2014
  - Time: 3:47:51 P.M.
- Manual:
  - Date: 07/01/2014
  - Time: 3:41:18 P.M.
- Internal Clock

### 10.2.2.1. NTP Time

Network Time Protocol (NTP) Servers are computers on the Internet that provide reliable time and date values for other equipment. NTP values are synchronized to be accurate to Coordinated Universal Time (UTC). Using NTP for time synchronization ensures the most accurate time possible for recorded footage. This setting should be used as long as the camera can access the Internet at least some of the time.

<b>1</b>	<b>NTP Server</b>	Default setting is <a href="http://pool.ntp.org">pool.ntp.org</a> , the most widely used NTP server. Change the server only if directed to do so by the network administrator.
	<b>Update</b>	Select how often to check for time updates from the drop-down. Do not set the value to “None” or the camera will never update if the time becomes inaccurate. Selection 1-48 hours. Default: 6 hours.
	<b>Time Shift</b>	Shift the camera time forward or behind by any number of minutes from the NTP time. Default: 0.
<b>Click “Apply” at the bottom right of the page to save modified settings.</b>		

### 10.2.2.2. Synchronize with PC's Time

Synchronizes to the connected PC's time setting. Not recommended unless the camera cannot access the Internet. The time will be updated when the PC logs in and connects to the camera.

<b>2</b>	<b>Date</b>	Current date the camera is receiving from the PC.
	<b>Time</b>	Current time the camera is receiving from the PC.
<b>Click “Apply” at the bottom right of the page to save modified settings.</b>		

### 10.2.2.3. Manual

Manually set the camera date and time settings. Should not be used unless there is a special need to synchronize to a non-standard time at regular intervals.

<b>3</b>	<b>Date</b>	Set the desired date.
	<b>Time</b>	Set the desired time.
<b>Click “Apply” at the bottom right of the page to save modified settings.</b>		

### 10.2.2.4. Internal Clock

Uses the last setting for date and time found in the camera and cannot be changed. This setting should not be used.

<b>4</b>	<b>Date</b>	Current date the camera is receiving from the PC.
	<b>Time</b>	Current time the camera is receiving from the PC.
<b>Click “Apply” at the bottom right of the page to save modified settings.</b>		





### 10.2.2.5. NTP Setup Instructions (For Cameras with Internet Access)

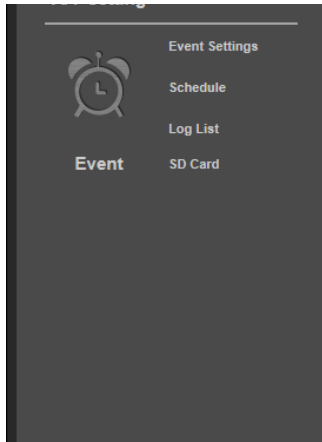

Event Settings

Schedule

Log List

Event

SD Card

Date Format:  yy/mm/dd  mm/dd/yy  dd/mm/yy

Time Zone: GMT-05:00

Enable Daylight Saving:

DST Start: Mar 2nd Sun 2:00 AM

DST End: Nov 1st Sun 2:00 AM

NTP:

NTP Server: pool.ntp.org

Update: 6 Hour

Time Shift: 0 Minutes [-1440..1440]

Synchronize with PC's time

Date: 12/27/2013

Time: 09:47:49

Manual

Date: 12/27/2013

Time: 09:47:45

Internal Clock

Network LED

Network LED:  Enabled  Disabled

Apply

- Set the Time Setting option to "NTP".
- Set the desired Date Format and Time Zone.
- If applicable to your region, check the box to enable Daylight Savings Settings:

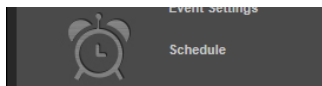

Enable Daylight Saving:

DST Start: Mar 2nd Sun 2:00 AM

DST End: Nov 1st Sun 2:00 AM

- Default DST settings are standard for most regions.
  - If changes are required, set the Month, Week, Day of Week, and Time for the DST "Start" and "End".
- Enter "pool.ntp.org" in the "NTP Server" field. Only use a different setting if instructed to do so by the network administrator.
  - 6 hours should be a sufficient setting for time updates. If constant or regular power outages occur, or Internet access is restricted at certain times, the setting may be decreased or increased.
  - Time shift may be set to a positive or negative number of minutes if the camera time must be off by a set amount. Do not use this setting to alter the time for Daylight Savings Time.
  - Click "Apply" at the bottom right of the page to save any changes made. Settings are now complete.

### 10.2.2.6. Time Setup for Cameras without Internet Access

For IP cameras connected to isolated networks, time may be manually synchronized to a separate system using the "Manual" setting (section [10.2.2.3. Manual](#)). This is ideal for locations where the camera may not be accessed for long periods, as long as power is stable.

If the camera will be regularly accessed by a mobile PC, the best way to set the time is to use the "Synchronize with PC's Time" setting (section [10.2.2.2. Synchronize with PC's Time](#)). This will reset the camera time each time it is accessed. The PC will be much more likely to have accurate settings, since it also connects to other networks and the Internet.



### 10.2.3. User Management

- **Navigation: Log in as an administrator.** From Home Screen, click “Config” button in top right corner, then click “User Management” in left column “System” sub-menu.

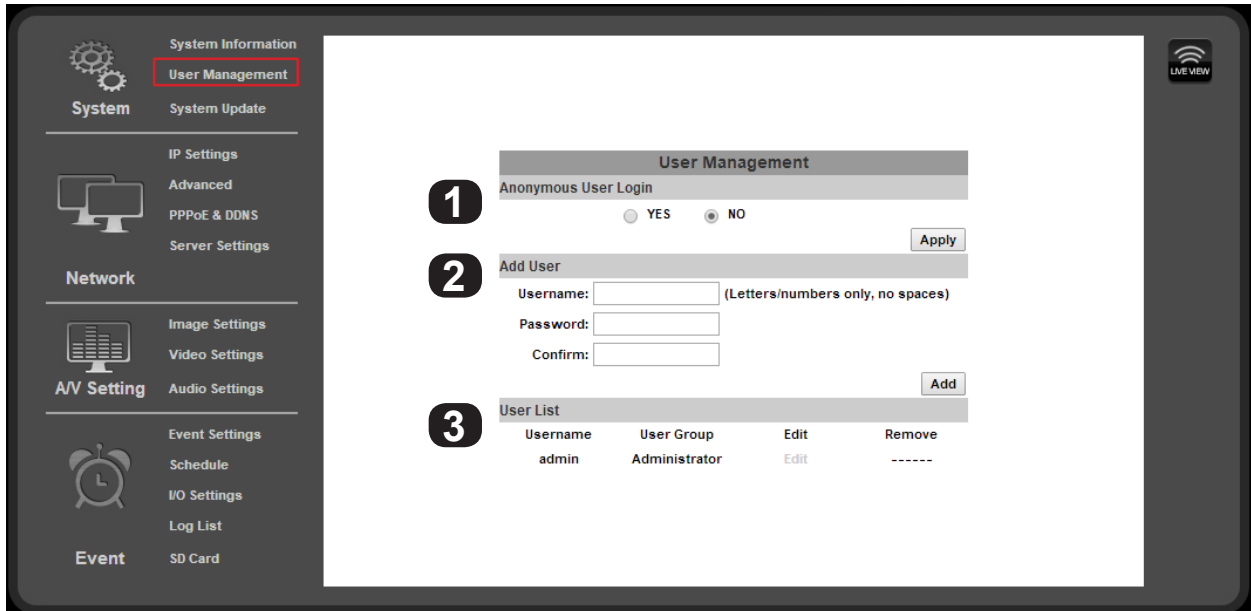

#### 10.2.3.1. Anonymous User Login

1

Enabling this feature allows anyone that visits the address of the camera to:

- View video
- Use Zoom, Mute, Video (Full), Record, and Picture
- Change the GUI size

Click “Apply” to the right of the option buttons to save modified settings.

#### 10.2.3.2. Add User (Guest Account only)

2

<b>Username</b>	Enter a username containing letters and numbers.
<b>Password</b>	Enter a password for the account containing letters and numbers.
<b>Confirm</b>	Enter the same password again to confirm the new account password.
Click “Add” to the right of the fields to save modified settings.	

#### 10.2.3.3. User List

3

<b>Username</b>	Displays registered usernames that have been set up.
<b>User Group</b>	Displays whether the user is an Administrator
<b>Edit</b>	Click the edit button to change the administrator username or password, or the password of a guest account. (Usernames for guest accounts cannot be changed, only deleted or added.)
<b>Remove</b>	(Guest Accounts only) Click to remove the user account.

#### 10.2.3.4. User Account Levels

- **Administrator** — Has access to all functions of the Camera and all configuration menus. Only one Administrator account may be created, and the account may not be removed. The username or password may be modified.
- **Guest** — Has access to view the Camera and limited control for saving recordings and photos. No configuration menus are accessible. Guests attempting to access to the camera configuration will be prompted for the Administrator username and password.

Once a guest username is created, only the password may be changed. To edit the account username, delete the username entry and re-enter it.





### 10.2.3.5. Administrator Account Setup

Once the camera is accessible on the network, the administrator password should be changed to prevent unwanted access. Select a new password up to ten characters in length made up of letters and numbers (no punctuation or symbols).

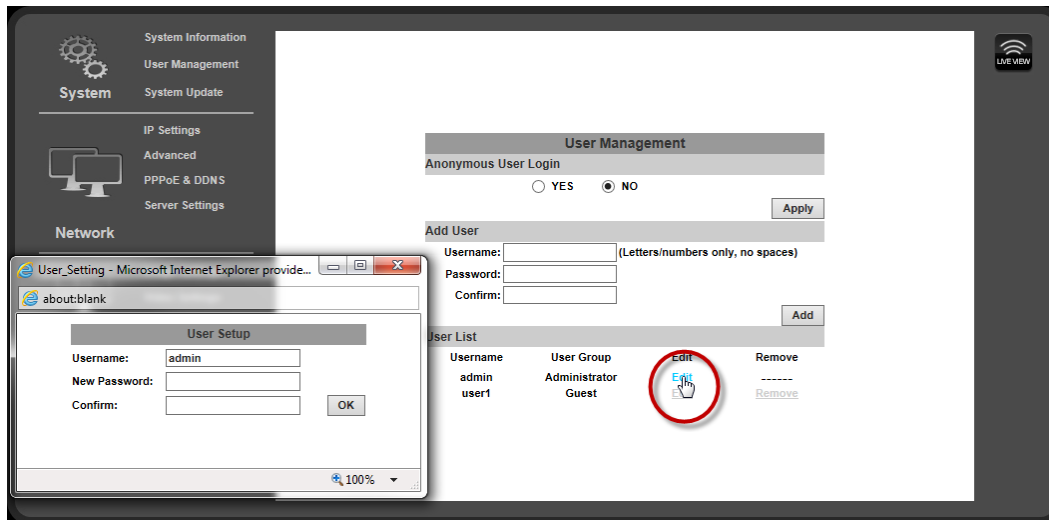

- A. Click the “Edit” button next to the username “admin” in the User List to open the User Setup window.
- B. Change the Administrator username and enter a new password, or re-enter the existing password in each password field, then click “OK” to save the changes.

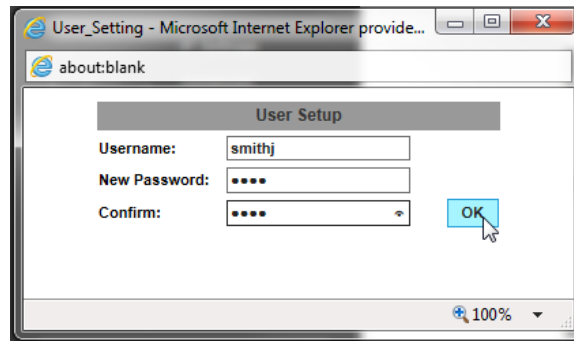

- C. After selecting OK, the camera will automatically log out. Enter the new log-in information in the pop-up and sign back into the camera as normal to continue setup. Be sure to record the Administrator account information in a safe place. If administrator account access is lost, a manual reset of the camera is required.

### 10.2.3.6. Add, Edit, or Remove a Guest Account

To create a new Guest account, enter the desired username and password in the fields as indicated on the previous page in section [10.2.3.2. Add User \(Guest Account only\)](#), and then click the “Add” button to add the new user.

After a Guest account has been created, the password may be changed by clicking the “Edit” button in the User List. To change the username, a new account must be created and the old one removed.

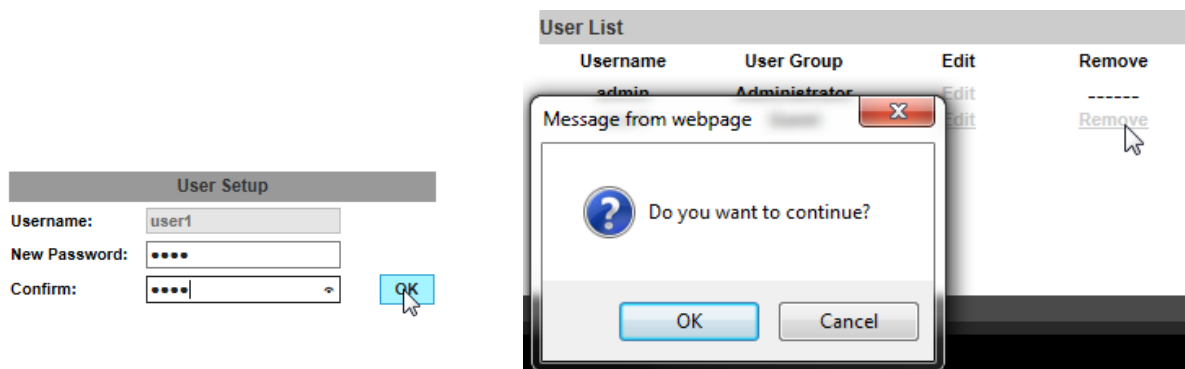



### 10.2.4. System Update

- **Navigation: Log in as an administrator.** From Home Screen, click “Config” button in top right corner, then click “User Management” in left column “System” sub-menu.

**Important! Updating Firmware MUST be performed over a wired IP connection to the device to ensure that a connection is sustained throughout the process. If connection is lost during update, use the IP Installer to find the device again and restart the update.**

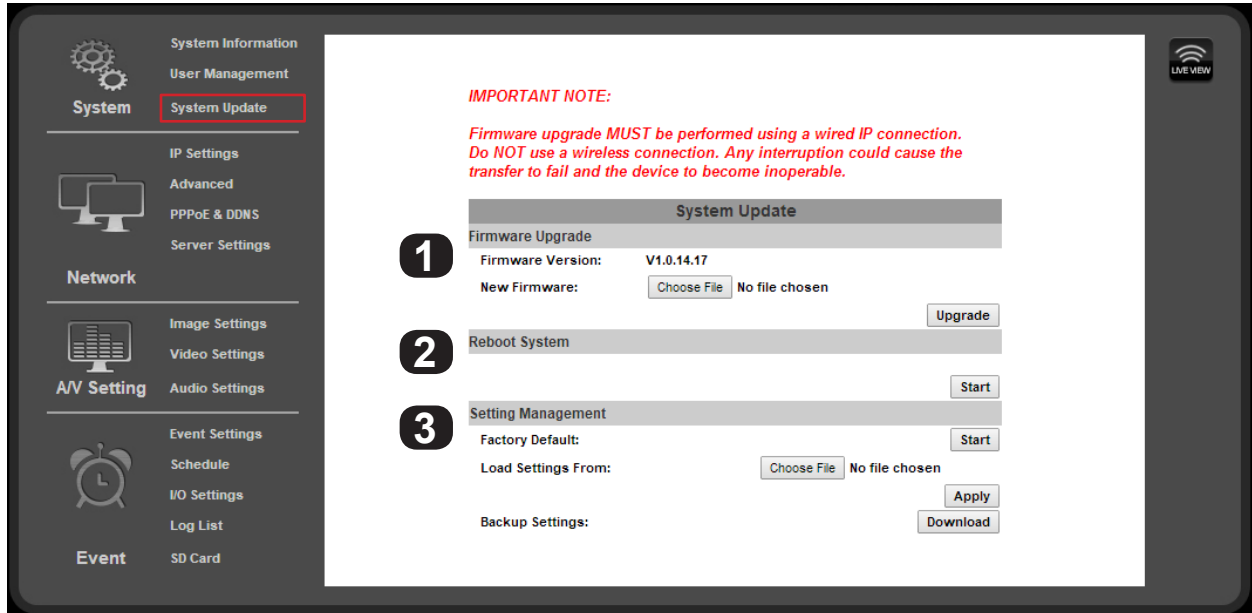

#### 10.2.4.1. Firmware Upgrade

See section [10.2.4.6. Upgrade the Firmware](#) for instructions on using this feature.

<b>1</b>	<b>Firmware Version</b>	Current firmware version installed on the camera.
	<b>New Firmware</b>	Click “Browse” to search for a firmware file to upload from the PC to the camera.
		<b>Click “Upgrade” (to the right) to upload the selected firmware in the “New Firmware” to the camera.</b>

#### 10.2.4.2. Reboot System

<b>2</b>	Reboot the Camera. No settings are changed.
	<b>Click “Start” to reboot the camera.</b>

#### 10.2.4.3. Setting Management

See sections [10.2.4.4. How to Back up Camera Settings](#) and [10.2.4.5. Load Backup Settings to the Camera](#) for instructions on using this feature.

<b>3</b>	<b>Factory Defaults</b>	Reset all settings to default. Click “Start” to begin the process.
	<b>Load Settings From:</b>	Click “Browse” to select a folder on the PC to load a camera backup file from.
	<b>Apply</b>	Click the “Apply” button to load the backup file to the camera.
	<b>Remove</b>	(Guest Accounts only) Click to remove the user account.

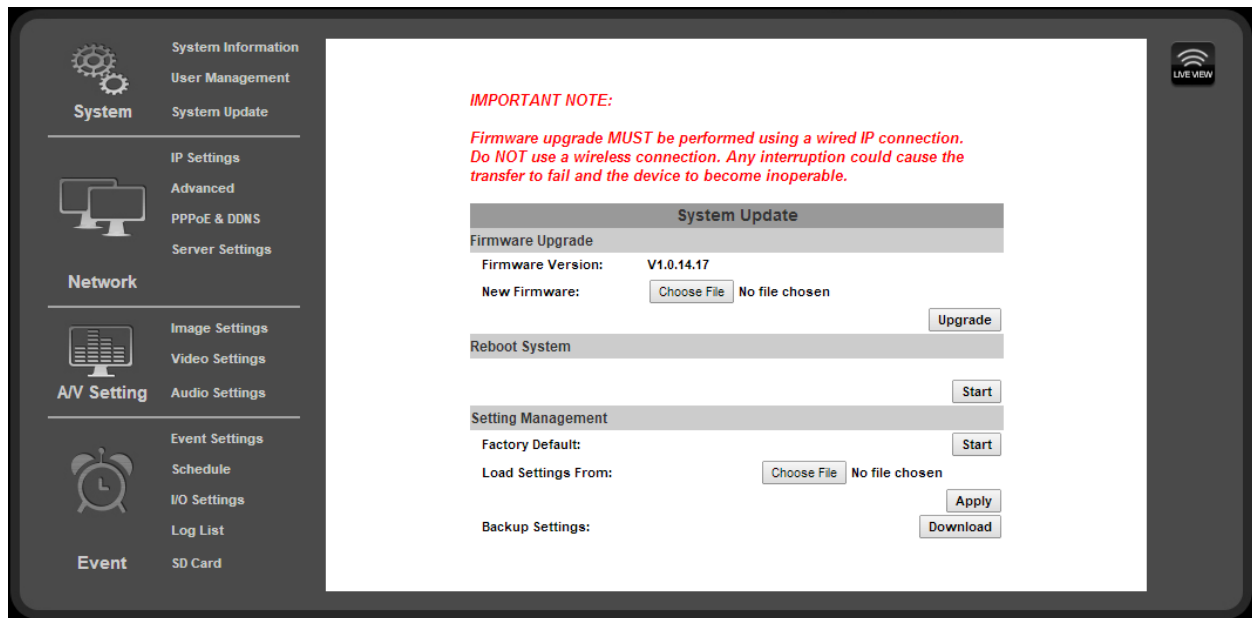

#### 10.2.4.4. How to Back up Camera Settings

Once the settings for a camera have been set up, they can be downloaded to a configuration backup file in case the camera is reset or must be replaced later. This file saves ALL settings from the configuration menus that can be modified.

- A. On the System Update page under the Setting Management sub-menu, click the Backup Settings: Download button on the right.
- B. (Internet Explorer only) A ribbon will appear on the bottom bar of the screen asking what you want to do with the “[Settings.CFG](#)” File. Click “Save As” so you can select the folder in which you want to save the file.



Depending on their security settings, some browsers may display a similar pop-up before the file can be saved. Allow the file to be downloaded and select the location for it using the “Save As” feature.

- C. (All Browsers) Select the location for the file from the window and then click “Save”. The file will download to the location.

#### 10.2.4.5. Load Backup Settings to the Camera

Load backed up settings to a camera after a firmware update, if camera access is lost, or to the new camera if it must be replaced.

**Backup files are saved with the suffix “.cfg”. DO NOT attempt to upload other file types or firmware files with modified suffixes to the camera.**

- A. On the System Update page, under the Setting Management sub-menu, click the Load Settings From: Browse button on the right.
- B. Browse the PC for the file and select it using the window. Click the Open button to return to the camera interface in the main browser window.
- C. Click the Apply button below the Browse button on the right.
- D. The camera will be updated with the settings in the file. After the update, it may be necessary to log into the camera again to regain access.



### 10.2.4.6. Upgrade the Firmware

**Important! Updating Firmware MUST be performed over a wired IP connection to the device to ensure that a connection is sustained throughout the process. If connection is lost during update, use the IP Installer to find the device again and restart the update.**

- A. Check for the latest firmware from the support page for the camera in use at [www.SnapAV.com](http://www.SnapAV.com). If the firmware version in the camera is below the version on the site, the firmware should be updated.
- B. Download the firmware to the PC that will be used to complete the upgrade.
- C. Ensure that all devices are on wired network connections.
- D. On the System Update page, under the Setting Management sub-menu, click the New Firmware: Browse button on the right.
- E. Browse the PC for the file and select it using the window. Click the Open button to return to the camera interface in the main browser window.
- F. Click the Upgrade button below the Browse button on the right. A message will appear (below). Click "OK".

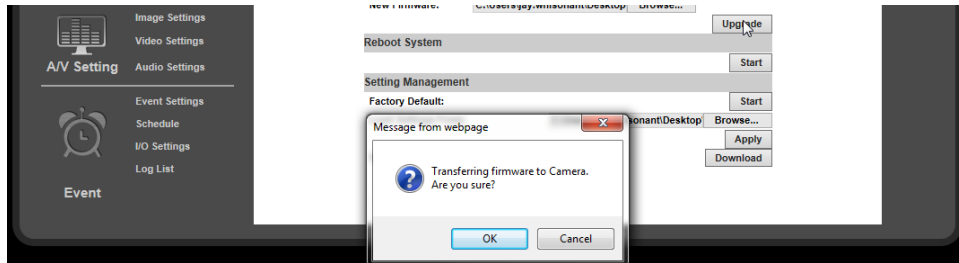

- G. Another message will appear. Click Okay, and the update will begin. Do not close or use the browser until prompted by the update process.

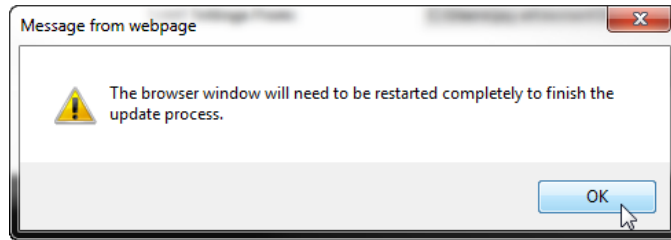

- H. After the update completes, the browser will prompt you to restart. Click "OK", then close and restart the browser. The camera will be visible on the IP Installer if the IP address has changed.

**Important! The browser MUST be closed and restarted for the update process to complete correctly.**

**Firmware upgrade in progress!**  
**Please do not perform other tasks until transfer is complete.**  
**This process may take several minutes.**



Writing Progress: 100%  
 Firmware upgrade complete.

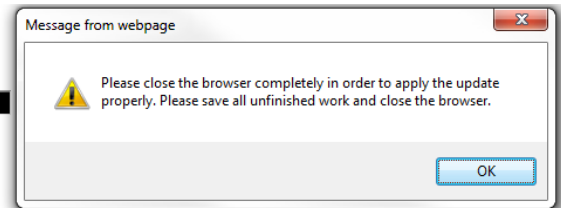

- I. After completing the update, check the settings on the camera. If they have reverted to default, a backup file may be loaded if one was saved prior to the update. See section [10.2.4.5. Load Backup Settings to the Camera.](#)
- J. The camera will be updated with the settings in the file. After the update, it may be necessary to log into the camera again to regain access.



## 10.3. Network IP Settings

- **Navigation: Log in as an administrator.** From Home Screen, click “Config” button in top right corner, then click “IP Settings” in left column.

### 10.3.1. Basic IP Settings

#### 10.3.1.1. IP Assignment

**Important!** These settings are required for the camera to communicate correctly at all times. Use only static IP addresses. Contact the network administrator if you are unaware of what the settings should be or cannot access the network for setup.

<b>1</b>	<b>DHCP/Static</b>	Select IP address type. Set to DHCP by default so that network settings are issued by the router. Change to a static IP address type to make changes to the IP settings. (All IP Assignment fields remain grayed out until Static is selected.)
	<b>IP Address</b>	Current IP address of the camera. Enter a new address here to change the static IP address. The address used must also be correctly configured for reserved use in the router. See router documentation to correctly reserve a static IP address.
	<b>Subnet Mask</b>	Subnet mask of the camera's subnet. (For smaller networks, usually 255.255.255.0, found in the router)
	<b>Gateway</b>	IP address of the router as seen by the network. (Found in the router)
	<b>DNS 0</b>	Domain Name Server of the camera network. (Found in the router)
	<b>DNS 1</b>	(Optional by network) Second Domain Name Server for the camera network. (Found in the router) <b>If no secondary DNS is set, use 0.0.0.0</b>
	<b>Click “Apply” at the bottom right of the page to save modified settings.</b>	



## Basic IP Settings, Continued

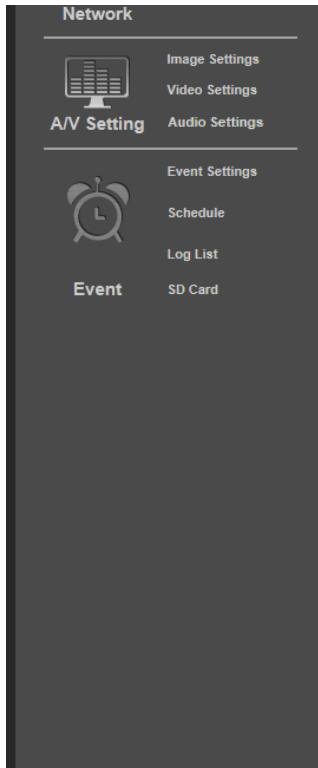

**2** Port Assignment

Web Page Port:

HTTPS Port:  [HTTPS Setting](#)

**3** UPnP

UPnP:  Enabled  Disabled

UPnP Port Forwarding:  Enabled  Disabled

External Web Port:

External HTTPS Port:

External RTSP Port:

RTSP Setting

RTSP Server:  Enabled  Disabled

RTSP Authentication:

RTSP Port:

RTP Start Port:  [1024..9997]

RTP End Port:  [1027..10000]

Multicast Setting (Based on the RTSP Server)

Streaming 1:

IP Address:  [224.3.1.0 ~ 239.255.255.255]

Port:  [1 ~ 65535]

TTL:  [1 ~ 255]

Streaming 2:

IP Address:  [224.3.1.0 ~ 239.255.255.255]

Port:  [1 ~ 65535]

TTL:  [1 ~ 255]

ONVIF

ONVIF:  v2.20  v1.01  Disabled

Security:  Enabled  Disabled

RTSP Keepalive:  Enabled  Disabled

Bonjour

Bonjour:  Enabled  Disabled

Bonjour Name:  @D4:6A:91:11:00:1D

LLTD (Link Layer Topology Discovery)

LLTD:  Enabled  Disabled

[Apply](#)

### 10.3.1.2. Port Assignment

**2**

<b>Web Page Port</b>	Port for accessing the camera web interface. Set to 80 by default. Each Camera must have a unique port number in order to access from outside the local network. To make port numbering easy to remember, use 4 digits: "8" followed by the last three numbers in the camera's IP address. This will also ensure that a port that is commonly used for another well-known service is not assigned to the Camera.
<b>HTTPS Port</b>	Used for access over the HTTPS protocol for better security. Advanced setup is required. See the section below, "HTTPS Access Setup".
<b>HTTPS Setting</b>	Click this button to access HTTPS certificate setup. Advanced setup is required. See the section below, "HTTPS Access Setup".
<b>Click "Apply" at the bottom right of the IP Setting page to save modified settings.</b>	

### 10.3.1.3. UPnP

When enabled, UPnP (Universal Plug and Play) allows the camera to appear under the PC network devices. To use this feature, UPnP must be enabled on the PC. Also contains settings for UPnP Port forwarding for use with compatible routers.

**3**

<b>UPnP</b>	Enable or disable UPnP. Enable to allow computers to auto-discover the camera on the network.
<b>UPnP Port Forwarding</b>	Enable or disable UPnP Port Forwarding. Enable this feature to automatically configure port forwarding on compatible routers.
<b>External Web Port</b>	External network port to be configured by a compatible router to access the Camera through HTTP. When available, router status will be displayed to the right of this field.
<b>External HTTPS Port</b>	External network port to be configured by a compatible router to access the Camera through HTTPS. When available, router status will be displayed to the right of this field.
<b>External RTSP Port</b>	External network port to be configured by a compatible router to access the Camera through RTSP. Also requires the configuration of RTSP. Router status will be displayed to the right of the field when available.
<b>Click "Apply" at the bottom right of the IP Setting page to save modified settings.</b>	



## Basic IP Settings, Continued



**4** **RTSP Setting**

RTSP Server:  Enabled  Disabled

RTSP Authentication:  [v]

RTSP Port:

RTP Start Port:  [1024..9997]

RTP End Port:  [1027..10000]

**5** **Multicast Setting (Based on the RTSP Server)**

**Streaming 1:**

IP Address:  [224.3.1.0 ~ 239.255.255.255]

Port:  [1 ~ 65535]

TTL:  [1 ~ 255]

**Streaming 2:**

IP Address:  [224.3.1.0 ~ 239.255.255.255]

Port:  [1 ~ 65535]

TTL:  [1 ~ 255]

**ONVIF**

ONVIF:  v2.20  v1.01  Disabled

Security:  Enabled  Disabled

RTSP Keepalive:  Enabled  Disabled

**Bonjour**

Bonjour:  Enabled  Disabled

Bonjour Name:  @D4:6A:91:11:00:1D

**LLTD (Link Layer Topology Discovery)**

LLTD:  Enabled  Disabled

### 10.3.1.4. RTSP Setting

The camera supports Real Time Streaming Protocol (RTSP). RTSP is a network protocol designed to allow media devices to stream content over Ethernet to devices on the same network or even to devices over the Internet. Instead of using a separate server or video recorder to control the video feed to remote devices, RTSP allows direct control of the stream from within the camera. This technology enables Wirepath™ products to stream video to devices even if they can't support any of our remote viewing apps. Leave RTSP disabled if it will not be used.

<b>4</b>	<b>RTSP Server</b>	Enable or disable RTSP. If RTSP is disabled, no connection can be made using the protocol.
	<b>RTSP Authentication</b>	“Disable” means that everyone who knows your camera’s IP Address can link to your camera via RTSP. No username and password are required. Under “Basic” and “Digest” authentication mode, the camera asks for a username and password before access is allowed. The password is transmitted as a clear text in “Basic” mode and hides it in “Digest” mode.
	<b>RTSP Port</b>	RTSP TCP communications port. Default: 554
	<b>RTSP Start Port</b>	Start port for UDP communications (1024...9997)
	<b>RTSP End Port</b>	End port for UDP communications (1027...10000)
<b>Click “Apply” at the bottom right of the page to save modified settings.</b>		

### 10.3.1.5. Multicast Setting (Based on RTSP Server)

Multicasting delivers a single stream to multiple network recipients simultaneously. All packets are copied identically to each recipient to save bandwidth. When using Multicast, be sure to enable the function “Force Multicast RTP via RTSP” in your media player, then key in the RTSP path of your camera: “rtsp://(IP address)” to receive the multicast stream. Configuration is not required for normal camera operation. This is an advanced feature that is used for access by some third-party interfaces.

<b>5</b>	<b>Streaming 1</b>	Streaming output 1 settings	
	<b>IP Address</b>	Enter an address for accessing the Multicast stream. (224.3.1.0 - 239.255.255.255)	
	<b>Port</b>	Enter the port used for Multicast communication. (1 - 65535)	
	<b>TTL</b>	Determines the number of users that can receive the stream simultaneously. Set to a higher value to allow more users. (1 - 255)	
	<b>Streaming 2</b>	Streaming output 2 settings	
	<b>IP Address</b>	Enter an address for accessing the Multicast stream. (224.3.1.0 - 239.255.255.255)	
	<b>Port</b>	Enter the port used for Multicast communication. (1 - 65535)	
	<b>TTL</b>	Determines the number of users that can receive the stream simultaneously. Set to a higher value to allow more users. (1 - 255)	
<b>Click “Apply” at the bottom right of the page to save modified settings.</b>			



### Basic IP Settings, Continued



**6** ONVIF  
 ONVIF:  v2.20  v1.01  Disabled  
 Security:  Enabled  Disabled  
 RTSP Keepalive:  Enabled  Disabled

**7** Bonjour  
 Bonjour:  Enabled  Disabled  
 Bonjour Name: IP\_Camera @D4:6A:91:11:00:1D

**8** LLTD (Link Layer Topology Discovery)  
 LLTD:  Enabled  Disabled



#### 10.3.1.6. ONVIF

The ONVIF (Open Network Video Interface Forum) standard is used by IP surveillance for communication across devices from various manufacturers. This setting does not require configuration when being used with Wirepath™ IP surveillance devices

**6**

<b>ONVIF</b>	Select the desired ONVIF standard to be used in the camera, or disable the feature.
<b>Security</b>	Enable or disable ONVIF security.
<b>RTSP Keepalive</b>	Enable or disable RTSP Keepalive. Enable if ONVIF is being used <b>and</b> RTSP has been configured to ensure that the connection is kept alive.
<b>Click “Apply” at the bottom right of the page to save modified settings.</b>	

#### 10.3.1.7. Bonjour

Enabling this setting allows for the Camera to be accessed by Mac computers as a Bonjour device.

**7**

<b>Bonjour</b>	Enable or disable Bonjour discoverability.
<b>Bonjour Name</b>	(If Bonjour is enabled) Select the custom name to be displayed in Bonjour.
<b>Click “Apply” at the bottom right of the page to save modified settings.</b>	

#### 10.3.1.8. Link Layer Topological Discovery (LLTD)

LLTD is a proprietary Microsoft technology that displays camera connection status and properties in a PCs network map. LLTD uses Media Access Control (MAC) addresses, not IP addresses. The PC must support LLTD and have it enabled in order to use this feature.

**8**

<b>LLTD</b>	Enable or disable LLTD
<b>Click “Apply” at the bottom right of the page to save modified settings.</b>	





### 10.3.2. Advanced IP Settings - HTTPS Access Setup

Accessing the Camera through HTTPS provides an additional security level for the video stream by requiring certificate authentication. To use this feature, a certificate must be created and then verified by a third party. To set up HTTPS access correctly, contact the HTTPS verifier.

Note: Wirepath™ Surveillance does not provide HTTPS certificates.

- **Navigation: Log in as an administrator.** From Home Screen, click “Config” button in top right corner, then click “Advanced” in left column, then click “ONVIF” from the sub-menu that opens.



#### 10.3.2.1. Created Request

<b>1</b>	<b>Subject</b>	Displays the subject content of the loaded certificate.
	<b>Date</b>	Displays the certificate creation date.
	<b>Content</b>	Click Content to display the content of the certificate. Click Remove to remove the certificate.
	<b>Remove</b>	Click Remove to remove the certificate.

#### 10.3.2.2. Installed Certificate

<b>2</b>	<b>Subject</b>	Displays the subject content of the loaded certificate.
	<b>Date</b>	Displays the certificate creation date.
	<b>Content</b>	Click Content to display the content of the certificate. Click Remove to remove the certificate.
	<b>Remove</b>	Click Remove to remove the certificate.

#### 10.3.2.3. Connection Types

<b>3</b>	Select HTTP, HTTPS, or HTTP & HTTPS. We recommend that this be set to “HTTP & HTTPS” unless all PCs will have the HTTPS certificate installed.
----------	--



### 10.3.3. Advanced IP Settings - SNMP

SNMP (Simple Network Management Protocol) is used for network management of larger networks. It allows for monitoring network devices such as IP cameras via a management host. This is an advanced setting that should be used only on larger systems. Configuration requires consulting with the network administrator.

- **Navigation: Log in as an administrator.** From Home Screen, click “Config” button in top right corner, then click “Advanced” in left column, then click “SNMP” from the sub-menu that opens.

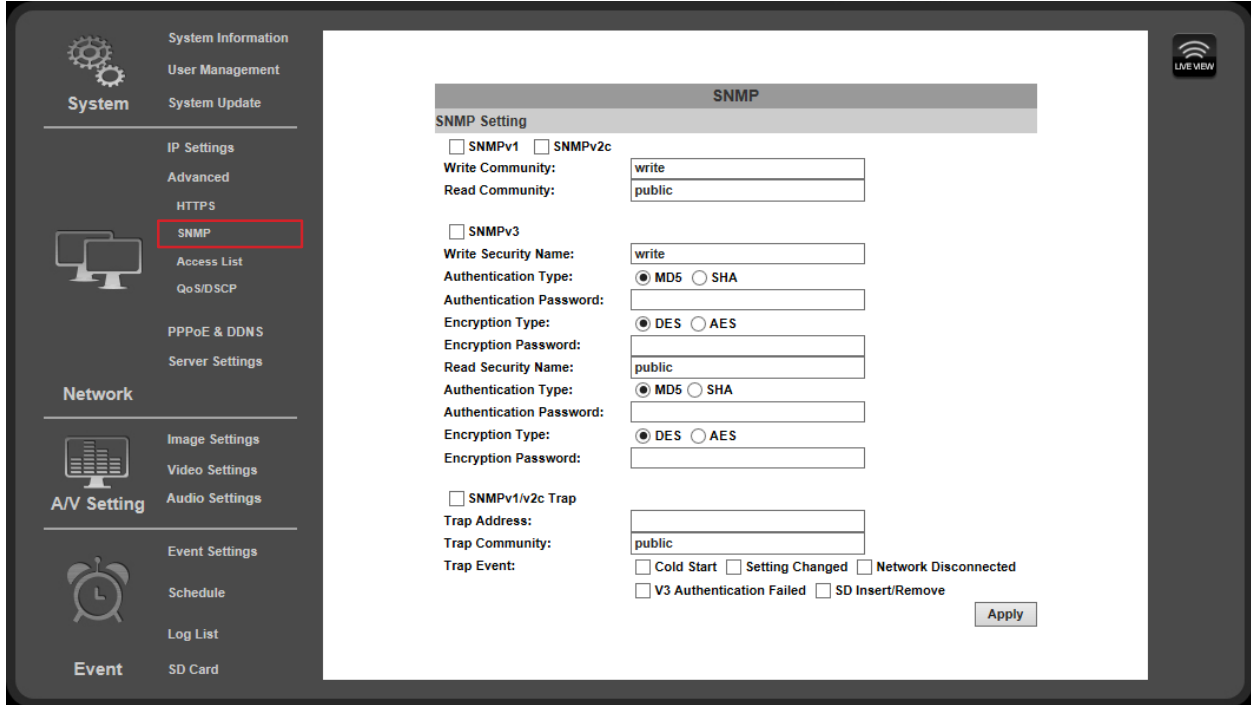

Setup for SNMP features vary by application. Consult with the network administrator for setup instructions.



### 10.3.4. Advanced IP Settings - Access List (IP Filter)

IP address filtering is used to allow or deny access to the camera from individual IP addresses or ranges of IP addresses. This adds an additional layer of security to the camera.

To ensure that the camera can be accessed by the Admin after setting up the list, the IP address of the administrator's PC must be enabled in the list. Or, if it is within a range of disabled addresses, select the "Allow Admin IP Always" check box and enter the address of the Admin PC.

- **Navigation: Log in as an administrator.** From Home Screen, click "Config" button in top right corner, then click "Advanced" in left column, then click "Access List" from the sub-menu that opens.

#### 10.3.4.1. IP Address Filter Setting

1

<b>Enable</b>	Check the box to enable IP address filtering for all visitors.
<b>IP Address</b>	Use this area to add IP addresses to the list for access or denial. Filtering must be enabled. See next section, <a href="#">10.3.4.2. Add or Remove IP Addresses or Ranges</a> for instructions.
<b>Access List</b>	Displays the IP addresses currently allowed or denied access to the camera. Click "Remove" in the Action column on the right to delete an entry.
<b>Allow Admin IP Address...</b>	Check the box to restrict Administrator access to only one address. (LAN or WAN address). See section <a href="#">10.3.4.3. Controlling Administrator Access</a> for instructions.
<b>Admin IP Address</b>	Enter the address the Administrator will access the camera from.
<b>Click "Apply" at the bottom right of the page to save Administrator IP Address access settings.</b>	



### 10.3.4.2. Add or Remove IP Addresses or Ranges

A. Enable IP Address Filtering to gain access to the settings:

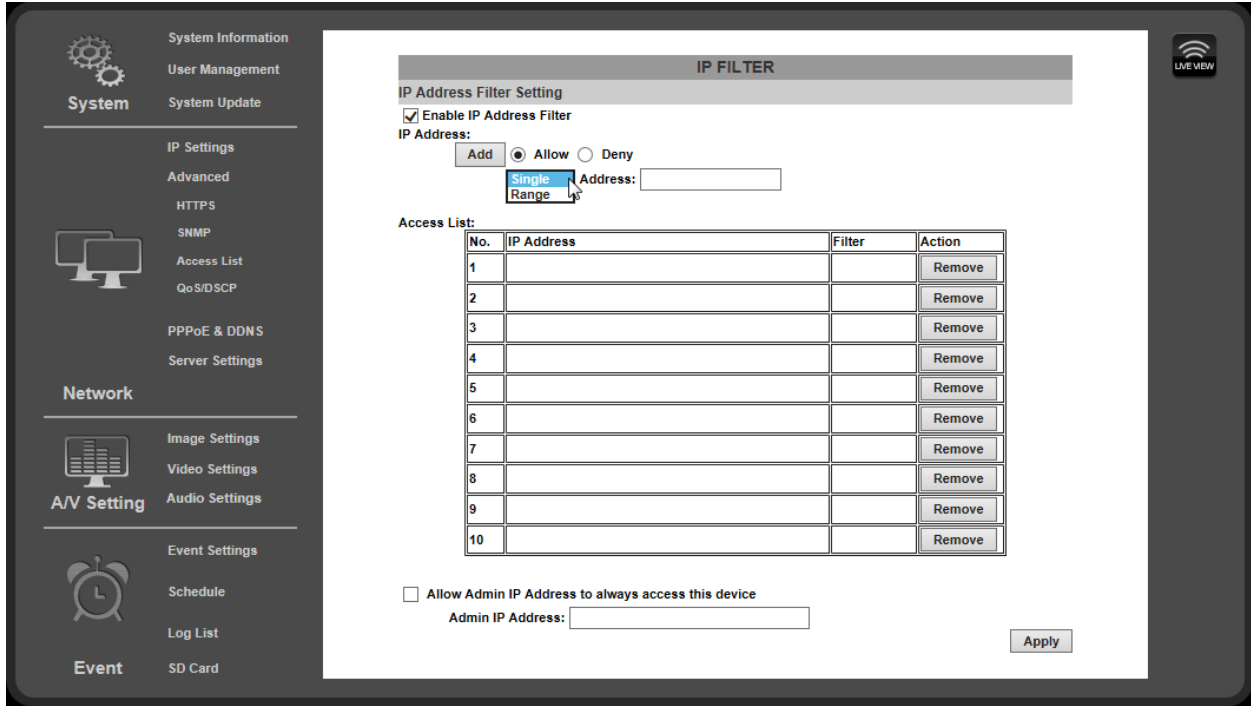

B. Enter an IP address or range of addresses into the field and select whether to allow or deny access:

#### Single IP Address:

#### IP Address Range:

IP Address:   Allow  Deny  
 Address: 192.168.1.75

IP Address:   Allow  Deny  
 Address: 192.168.1.75 - 192.168.1.85

Access List:

No.	IP Address	Filter	Action
1	192.168.1.75	Deny	<input type="button" value="Remove"/>

Access List:

No.	IP Address	Filter	Action
1	192.168.1.75-192.168.1.85	Allow	<input type="button" value="Remove"/>

C. After clicking the “Add” button, the new entry will be added to the list.

D. Click the “Remove” button to the right to remove an entry from the list.

### 10.3.4.3. Controlling Administrator Access

For installations where the Administrator account is only accessed from one computer, the IP address of the computer may be reserved. Enabling this feature prevents modification of settings on the camera from any other IP address.

**Note:** If another device is issued the same IP address, the new device will be granted Admin access. Be sure to use a reserved or static IP address for the computer, or Admin rights may be lost. If this occurs, a physical camera reset is required.

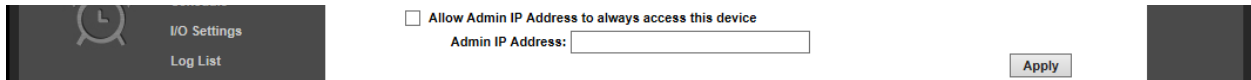

A. Check the box for “Allow Admin IP Address to always access this device”.

B. Enter the IP address for the Admin computer.



### 10.3.5. Advanced IP Settings - QoS/DSCP

Quality of Service (QoS) is used within a network to define priority levels for selected traffic. This allows for a higher level of bandwidth to be used whenever a particular type of traffic is being sent to avoid latency and packet loss. **The network administrator should be consulted before enabling this feature.**

For example: Video streams require more bandwidth than email notifications. By assigning a higher DSCP (Differentiated Services Code Point) number to video streams guarantees the quality of the stream on the network.

- **Navigation: Log in as an administrator.** From Home Screen, click “Config” button in top right corner, then click “Advanced” in left column, then click “QoS/DSCP” from the sub-menu that opens.

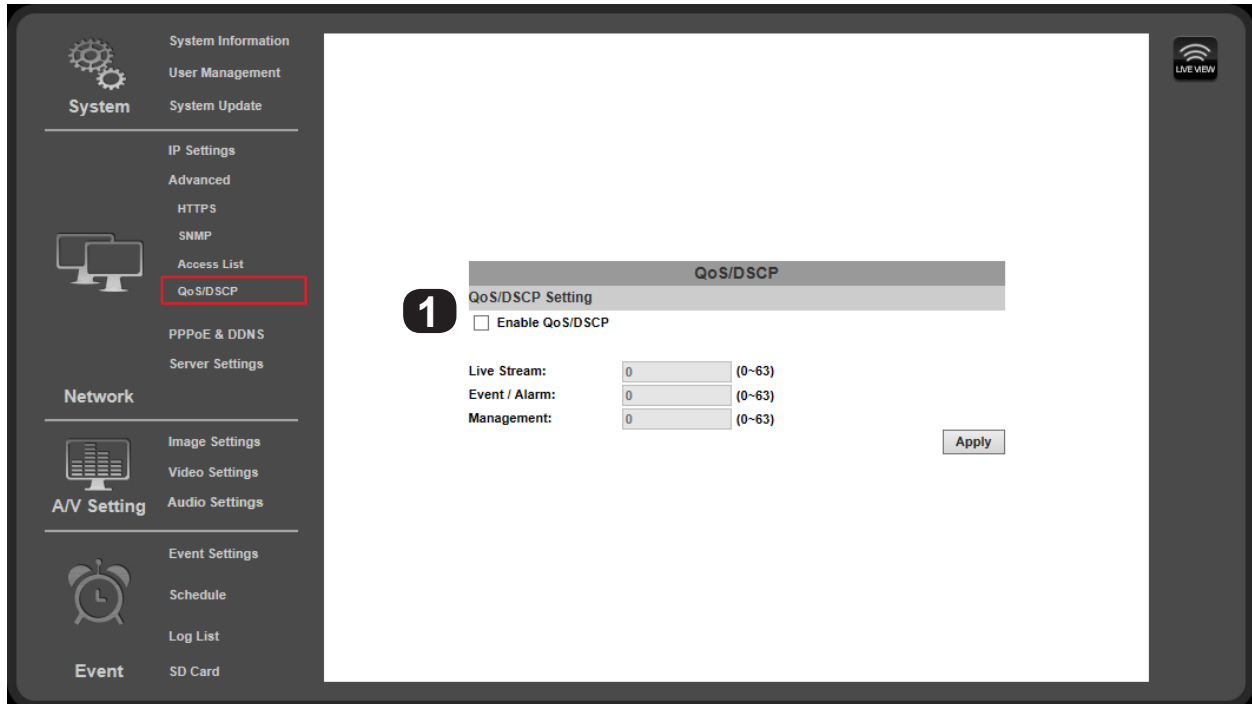

#### 10.3.5.1. QoS / DSCP Setting

**1**

<b>Enable QoS/DSCP</b>	Check the box to enable this feature.
<b>Live Stream</b>	Enter a DSCP value between 0 and 63 to use when live stream traffic is being sent across the network.
<b>Event/Alarm</b>	Enter a DSCP value between 0 and 63 to use when event/alarm traffic is being sent across the network.
<b>Management</b>	Enter a DSCP value between 0 and 63 to use when management traffic is being sent across the network.
<b>Click “Apply” at the bottom right of the page to save modified settings.</b>	



### 10.3.6. PPPoE Setup

#### 10.3.6.1. PPPoE Overview

Point-to-Point Protocol Over Ethernet (PPPoE) is a network protocol primarily used with DSL (Digital Subscriber Line) providers and modems. This protocol requires a login to connect to the modem even when a router is used. Configuration of these settings is not required to operate the camera on a standard network.

- **Navigation: Log in as an administrator.** From Home Screen, click “Config” button in top right corner, then click “PPPoE & DDNS” in left column menu.

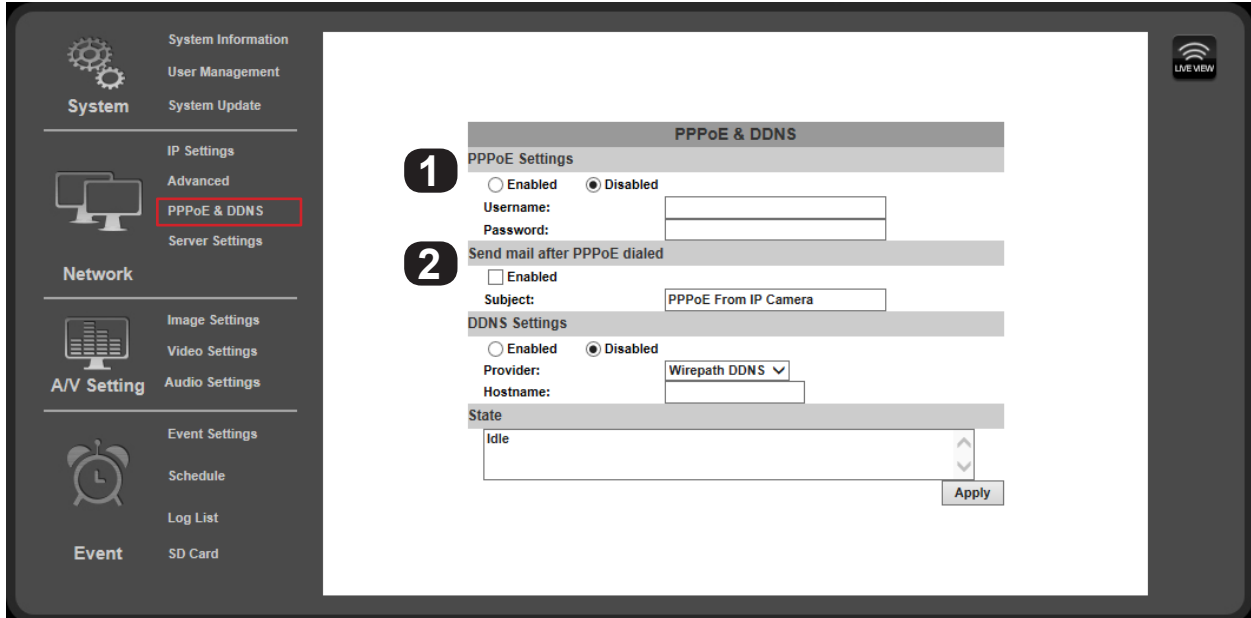

#### 10.3.6.2. PPPoE Settings

<b>1</b>	<b>Enabled/ Disabled</b>	Turn PPPoE features on or off. Enable to use PPPoE to access the camera.
	<b>Username</b>	Enter the login name provided by the Internet Service Provider (ISP).
	<b>Password</b>	Enter the password provided by the Internet Service Provider (ISP).
<b>Click “Apply” at the bottom right of the page to save modified settings.</b>		

#### 10.3.6.3. Send Mail after PPoE Dialed

<b>2</b>	<b>Enabled</b>	Click Enable to send an email when the PPPoE is dialed.
	<b>Subject</b>	Enter a subject line to be used for outgoing emails.
<b>Click “Apply” at the bottom right of the page to save modified settings.</b>		



## 10.3.7. DDNS Setup

### 10.3.7.1. DDNS Overview

Dynamic Domain Name Servers (DDNS) map an alphanumeric Internet domain name to a network's WAN IP address. When configured, DDNS enables login to cameras from anywhere on the Internet without having to remember a numeric address that could change on a regular basis. Configuring DDNS is not required for remote access, but makes access easier. Only one device on the network requires DDNS setup. After one device is configured, the same address can be used to access other devices as long as ports are set differently for each camera. (See section [10.3.7.4. Setting Up a DDNS Address – WirepathDNS](#))

Our free Wirepath™ DNS service is fast to set up right through the camera interface – no PC required – and it provides maximum uptime thanks to redundant USA-based servers located across the country.

**If an NVR is being used in the system, we recommend that remote DDNS access is handled through the NVR. Only configure remote access for cameras that must be accessed from outside the local network independently.**

- **Navigation: Log in as an administrator.** From Home Screen, click “Config” button in top right corner, then click “PPPoE & DDNS” in “Network” group of left column menu.

The screenshot displays the 'PPPoE & DDNS' configuration page. The left sidebar contains a menu with categories: System (System Information, User Management, System Update), Network (IP Settings, Advanced, **PPPoE & DDNS**, Server Settings), A/V Setting (Image Settings, Video Settings, Audio Settings), and Event (Event Settings, Schedule, Log List, SD Card). The main content area is titled 'PPPoE & DDNS' and includes the following sections:

- PPPoE Settings:** Radio buttons for 'Enabled' and 'Disabled' (selected). Fields for 'Username:' and 'Password:'.
- Send mail after PPPoE dialed:** Radio buttons for 'Enabled' and 'Disabled' (selected). A 'Subject:' field with the value 'PPPoE From IP Camera'.
- DDNS Settings:** Radio buttons for 'Enabled' and 'Disabled' (selected). A 'Provider:' dropdown menu set to 'Wirepath DDNS'. A 'Hostname:' field.
- State:** A dropdown menu currently showing 'Idle'. An 'Apply' button is located at the bottom right.

### 10.3.7.2. DDNS Settings

**1**

<b>Enabled/Disabled</b>	Turn DDNS functionality on or off. Enable to use DDNS to access the camera from outside of the local network.
<b>Provider</b>	Select a provider for the DDNS service being used. (See Overview)
<b>Hostname</b>	Prefix for the DDNS URL. Example: For DDNS address “ipdemo.wirepath.dns.com” the hostname is “ipdemo”.

Click “Apply” at the bottom right of the page to save modified settings.

### 10.3.7.3. State (DDNS)

**2**

Displays the current state of the DDNS service. Will update within 5 minutes of assigning a DDNS and will update regularly.



### 10.3.7.4. Setting Up a DDNS Address – WirepathDNS

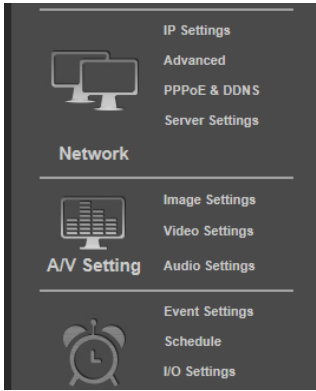

**PPPoE & DDNS**

**PPPoE Settings**

Enabled  Disabled

Username:

Password:

**Send mail after PPPoE dialed**

Enabled

Subject:

**DDNS Settings**

Enabled  Disabled

Provider:

Hostname:

**State**

- A. To use Wirepath DDNS service, enable the DDNS feature by selecting the button.
- B. Enter a prefix for the address in the host name field as shown in the example above (system1).
- C. Click “Apply” in the bottom right corner to save the address. After a moment, the page will reload and the address will appear in the “State” box as shown below:

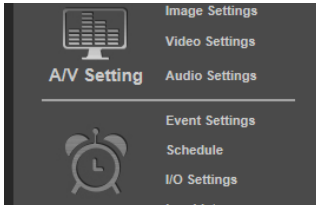

**DDNS Settings**

Enabled  Disabled

Provider:

Hostname:

**State**

- D. DDNS is now correctly set up. To complete setup for remote access, log into the router and forward the port for the camera to its IP address.





### 10.3.8. Server Settings

Server Settings menus allow configuration of the message and file transfer systems used by the camera to send emails, video files, or snapshots to: email recipients, to an FTP server, or to be hosted over the local network.

When you navigate to the Server Settings page, the Email settings will appear by default. To change settings for FTP or Network Sharing, click the gray banner for the feature, and the settings will load for that feature. Click “Apply” in the bottom right corner to save the settings before navigating to any menu outside of the Server Settings menu page.

- **Navigation: Log in as an administrator.** From Home Screen, click “Config” button in top right corner, then click “Server Settings” in left column menu.

#### 10.3.8.1. Email Notifications

Allows for email notifications to be sent based on various triggers.

#### 10.3.8.2. Mail Settings

1

<b>Login Method</b>	Click the drop-down and select Account or Anonymous (if no login for the email account is required). The login method used depends on the requirement of the email server being used.
<b>Mail Server</b>	Enter the address of the SMTP server. Contact the network administrator for corporate accounts (like a Microsoft Exchange server), or the email provider for personal accounts (like Gmail or Microsoft email) <b>The SMTP server used must be configured for POP3 protocol.</b>
<b>Username</b>	(Login Method: Account only) Enter the username for the email account being used to send notifications. Some servers require the full email address to be entered.
<b>Password</b>	(Login Method: Account only) Enter the password for the email account being used to send notifications.
<b>Sender's Mail</b>	Enter any email address to be used on the emails being sent. Used for notification purposes only. Use a name that identifies the camera sending the email. Example: JonesDoorCam@Gmail.com. <i>Some SMTP servers might replace this information with the username of the account. This is normal.</i>
<b>Receiver's Mail</b>	Enter email addresses for recipients of email notifications. Separate addresses with commas. Example: johnS@123acme.com, user1@123acme.com
<b>Bcc Mail</b>	Enter additional recipients as with the field above (Receiver's Email). These recipients will not see other addressees listed in the “To:” field of the email.
<b>Mail Port</b>	Set the port number used by the email server to pass data out of the network. Most unsecured accounts will use port 25. Secure accounts may use 465, 587, or other. Contact the email service provider or network administrator to confirm the correct port.
<b>Secure Connect</b>	Check the box to enable a secure connection when sending emails. This is required for most SMTP servers.
<b>Test</b>	Click test to send a test email to all receivers and Bcc mail addresses when setting up notifications.
<b>Click “Apply” at the bottom right of the page to save modified settings.</b>	



### 10.3.8.3. FTP Settings

An FTP server is a remote computer server the camera connects to over the network or Internet. When an FTP server is configured, recorded video and snapshot files can be stored on the server for later access. Contact the network administrator for FTP server setup information.

- **Navigation: Log in as an administrator.** From Home Screen, click “Config” button in top right corner, then click “Server Settings” in left column menu. In the Server Settings sub-menu on the main window of the page, click Network Share Settings”.

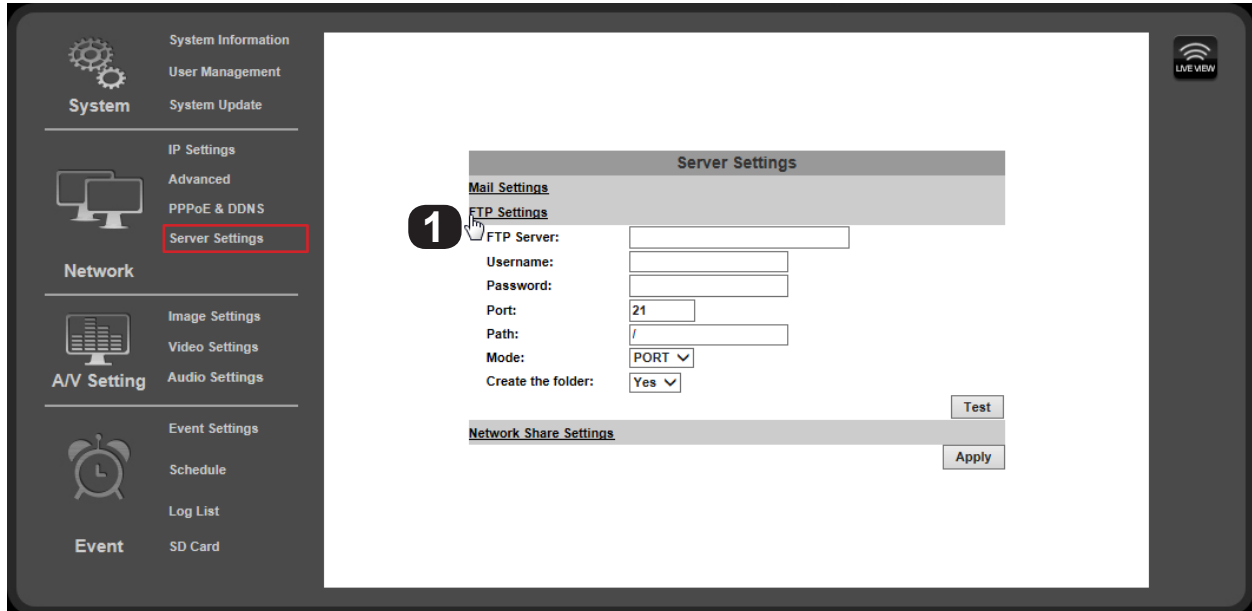

**1**

<b>FTP Server</b>	Enter the FTP server address to which files will be transferred.
<b>Username</b>	Enter the FTP account username.
<b>Password</b>	Enter the FTP account password.
<b>Port</b>	Enter the port configured for FTP connections. Usually port 21.
<b>Path</b>	Directory for the files to be saved to on the FTP server. Avoid using spaces in file names. Use underscores instead.
<b>Mode</b>	Select the data channel to use for logging into the FTP server, either “PORT” or “PASV”. This is an advanced setting and should not be changed from “PORT” unless instructed to by the network administrator.
<b>Create the Folder</b>	Select “Yes” to have a new folder created to contain each new file. The folder will be named the same as the file. Select “No” to save all files directly to the selected folder.
<b>Test</b>	Click to send a test file to the FTP server to confirm that new settings are correct.
<b>Click “Apply” at the bottom right of the page to save modified settings.</b>	



### 10.3.8.4. Network Share Settings

- **Navigation: Log in as an administrator.** From Home Screen, click “Config” button in top right corner, then click “Server Settings” in left column menu. In the Server Settings sub-menu on the main window of the page, click “Network Share Settings”.

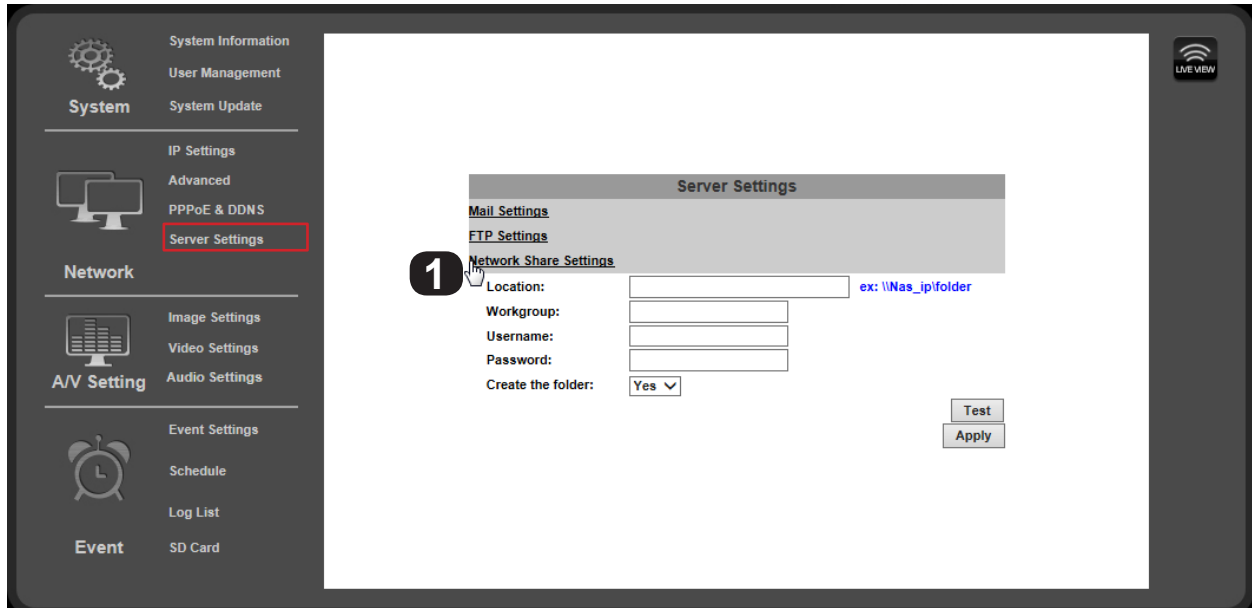

**1**

<b>Location</b>	Network path of the Samba/network share server and share name. The server must be identified by its IP address and followed by the network share name. Example: \\192.168.0.250\JonesFolder”.
<b>Workgroup</b>	(Optional, may be left blank) Enter the Work Group name for the Network Share server.
<b>Username</b>	Enter the Network Share server account username.
<b>Password</b>	Enter the Network Share server account password.
<b>Create the Folder</b>	Select Yes to have a new folder created to contain each new file. The folder will be named the same as the file. Select no to save all files directly to the selected folder.
<b>Test</b>	Click the test button to send a file to the Network Share server. Use Test to confirm that new settings are correct.
<b>Click “Apply” at the bottom right of the page to save modified settings.</b>	



## 10.4. Camera A/V Settings

### 10.4.1. Image Settings Menu

The image setting menu is used to set up the camera view for the best image possible. Brief descriptions of the menu are given below. Complete instructions for setup are in the following sections.

- **Navigation: Log in as an administrator.** From Home Screen, click “Config” button in top right corner, then click “Image Settings” in the left column menu.

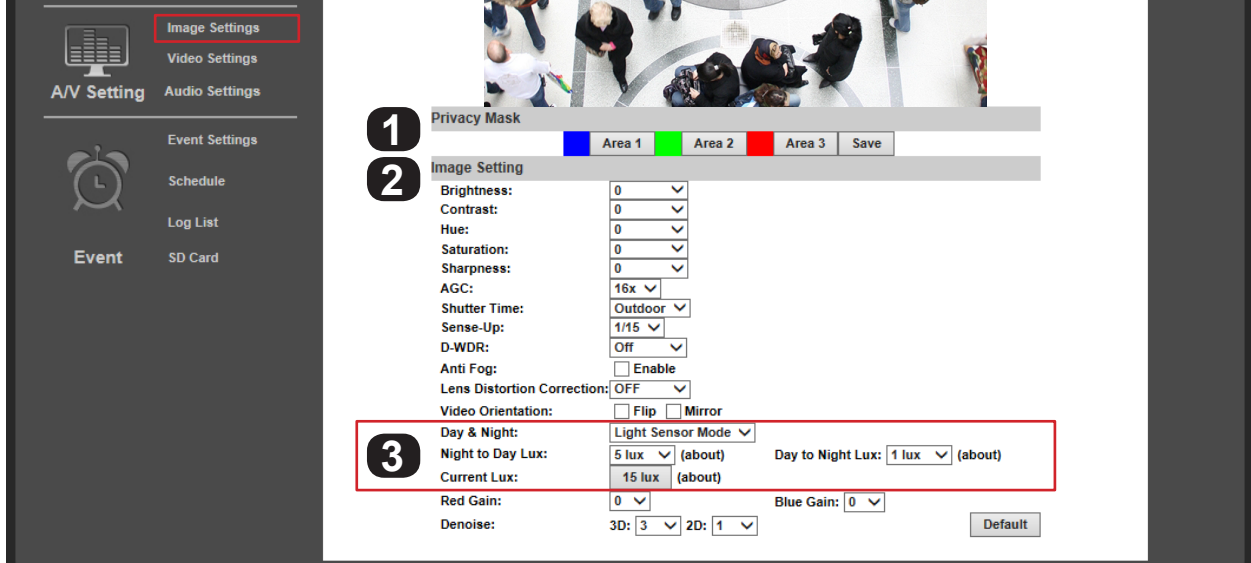

<b>1</b>	<b>Privacy Mask</b>	See section <a href="#">10.4.2.5. How to Configure Privacy Masks</a>
<b>2</b>	<b>Image Setting</b>	
	<b>Brightness</b>	Adjust overall brightness from -4 (Low) to +4 (High). Default: zero (0).
	<b>Contrast</b>	Adjust white levels from -4 (Low) to +4 (High). Default: zero (0).
	<b>Hue</b>	Adjust the color tone (or tint) between -4 (Blue) and +4 (Red). Default: zero (0).
	<b>Saturation</b>	Adjust color intensity from -4 (Low) to +4 (High). Default: zero (0).
	<b>Sharpness</b>	Adjust edge detail from -4 (Low) to +4 (High). Default: zero (0).
	<b>AGC</b>	Auto Gain Control balances high contrast scenes. Adjust from 16x (Low) to 64x (High). Default: 16x.
	<b>Shutter Time</b>	Use automatic Indoor or Outdoor preset modes or set 1/30(Slow)-1/1000 (Fast). Default: Outdoor.
	<b>Sense-Up</b>	Set slow shutter time for use in low light areas from 1/5 (Slow) to 1/30 (Fast). Default: 1/15.
	<b>D-WDR</b>	Digital Wide Dynamic Range balances dark and bright areas in low light scenes to maintain high image quality. Turn on and set from 1 (Low) to 8 (High). Default: Off.
	<b>Anti-Fog</b>	Check Enable to clear foggy scenes using software, Default: Off.
	<b>Lens Distortion Correction</b>	Adjust the image so that curvature image distortion caused by the lens is reduced to a minimum. Turn on and set from 1 (Low) to 8 (High). Default: Off.
	<b>Lens Orientation</b>	Check the box for Flip or Mirror to change the image appearance. Both settings are disabled by default.
	<b>Red/Blue Gain</b>	Set the red and blue balance from -5 (Low) to 5 (High). Default: 0.
	<b>Digital Noise Reduction</b>	<b>3D</b> - Reduces noise around moving objects. Default: 5. <b>2D</b> - Reduces noise around stationary objects. Default: 1.
	<b>Default</b>	Click to reset all Image Setting menu values.
<b>3</b>	<b>Day &amp; Night Setting</b>	See section <a href="#">10.4.2. How to Configure Day &amp; Night Settings (Color Modes)</a>



#### 10.4.1.1. Tips for Getting the Best Camera Image

- Too much brightness causes the image to fade. Too little brightness will cause dark colors to run together.
- Too much contrast will cause obscured details. Too little contrast will cause the image to lose clarity and brightness.
- Too much saturation will cause colors to be inaccurate. Too little saturation will cause the image to appear black and white.
- Increase AGC only if contrast in the scene is too dark in some areas and too bright in others. Too much AGC can drastically reduce image clarity in low-light scenes.
- Lower shutter time values increase the amount of light available, but can increase movement blur. Higher shutter time values decrease lighting, but motion is captured more clearly.
- Leave Sense-Up OFF unless required for scenes containing very bright and dark areas at the same time (such as heavily backlit windows).
- DNR can reduce some digital noise that occurs in dimly lit scenes. Use the lowest setting that provides adequate image quality.



### 10.4.2. How to Configure Day & Night Settings (Color Modes)

The camera can record an image in color or black-and-white mode. Color mode requires more light but provides the best image given ideal conditions. Black and white requires much less light, and the camera's IR can be turned on to illuminate the scene.

If the camera view is not ideal after installation, adjustments can be made to optimize the automatic settings or set them manually.

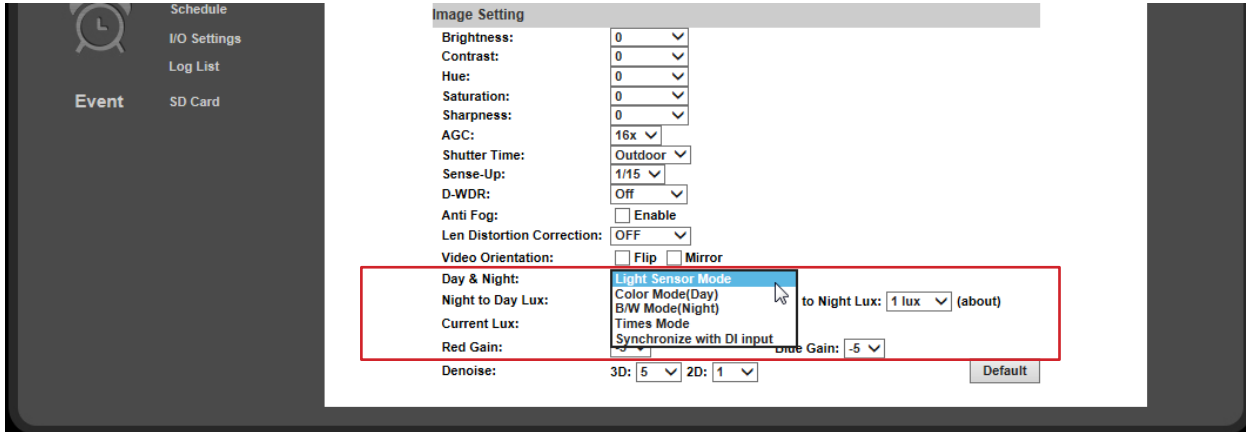

#### 10.4.2.1. Day & Night Modes

Select the mode from the Day and Night drop-down menu.	
<b>Light Sensor Mode (Default)</b>	Uses camera light sensor to switch between Color (Day) and B&W (Night) modes. See section <a href="#">10.4.2.3. Light Sensor Mode (Default Mode)</a>
<b>Color Mode (Day)</b>	Forces camera to Color (Day) mode only. Useful for scenes that will be consistently lit and when color video is always preferred. All sub-settings are disabled in Day mode. Use the Image Settings to adjust the picture. See section <a href="#">10.4.1. Image Settings Menu.</a>
<b>B&amp;W Mode (Night)</b>	Forces camera to B&W (Night) mode only, increasing low-light performance. Useful for scenes that will consistently be poorly lit.
<b>Times Mode</b>	Forces camera to switch between Color and B&W modes at specific times.

If the camera view is not ideal after installation, adjustments can be made to optimize the automatic settings.

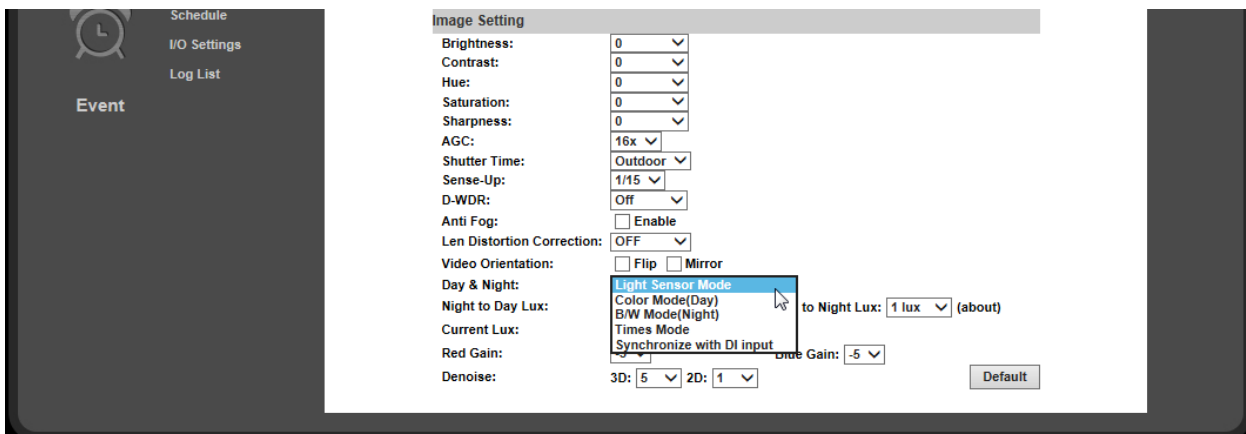



### 10.4.2.2. Day & Night Modes

Select the mode from the Day & Night drop-down menu.	
<b>Light Sensor Mode (Default)</b>	Uses camera light sensor to switch between Color (Day) and B&W (Night) modes. See section <a href="#">10.4.2.3. Light Sensor Mode (Default Mode)</a>
<b>Color Mode (Day)</b>	Forces camera to Color (Day) mode only. Useful for scenes that will be consistently lit and when color video is always preferred. All sub-settings are disabled in Day mode. Use the Image Settings to adjust the picture. Section <a href="#">10.4.1. Image Settings Menu</a>
<b>B&amp;W Mode (Night)</b>	Forces camera to B&W (Night) mode only, increasing low-light performance. Useful for scenes that will consistently be poorly lit.
<b>Time Mode</b>	Forces camera to switch between Color and B&W modes at specific times.
<b>Synchronize with DI Input</b>	Selects Color and B&W modes based on the state of a contact output from an external device (such as a security lighting sensor) connected to the camera's DI input. When the connection is Open the camera switches to Color (Day) mode; when the connection is Closed, camera switches to B&W (Night) mode.

### 10.4.2.3. Light Sensor Mode (Default Mode)

The default day-night settings are usually ideal. The camera has been calibrated to run in color mode as long as enough ambient light is available for the sensor to use. Once the scene begins to darken, the camera will adjust to black and white night mode, and the IR LEDs will turn on as needed. Change the Lux variables to optimize the switch between modes for the scene.



<b>Night to Day Lux</b>	Sets the detected light level at which the camera will switch from B&W (Night) mode to Color (Day) mode. Selected level must be at least 4 units higher than Day to Night Lux setting. <ul style="list-style-type: none"> <li><b>Higher</b> – requires a brighter scene to switch to Day mode.</li> <li><b>Lower</b> – requires a more dimly-lit scene to switch to Day mode.</li> </ul>
<b>Day to Night Lux</b>	Sets the detected light level at which the camera will switch from Color (Day) to B&W (Night) mode. Selected level must be at least 4 units lower than Night to Day Lux setting. <ul style="list-style-type: none"> <li><b>Higher</b> – turns to Night mode faster (scene can be brighter and Night mode still turns on).</li> <li><b>Lower</b> – has to be darker before switching to Night mode.</li> </ul>
<b>Current Lux</b>	Indicator to display current lighting level detected by the camera.

### 10.4.2.4. Day & Night Times Mode

Use Times mode to set when the camera switches between Day & Night modes. System time should be set up to synchronize to a reliable source for this feature to be reliable. See section [10.2.1.3. Time Setting](#) to set the time.

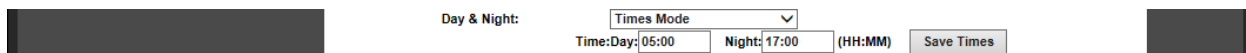

<b>Time:</b>	Settings are in 24:00 time. Example 3:00 PM = 15:00
<b>Day</b>	Set the time for the camera to switch to Day mode.
<b>Night</b>	Set the time for the camera to switch to Night mode.
<b>Click “Save Times” on the right side of the menu to the save the times entered.</b>	



### 10.4.2.5. How to Configure Privacy Masks

Privacy mask allows for areas of an image to be blocked out to avoid unwanted capturing of sensitive areas.

Example: A camera used to monitor the front lawn of a house would have the windows on the neighboring homes masked to avoid peeping on the neighbors.

- **Menu Navigation: Log in as an administrator.** From Home Screen, click “Config” button in top right corner, then click “Image Settings” in the left column menu.

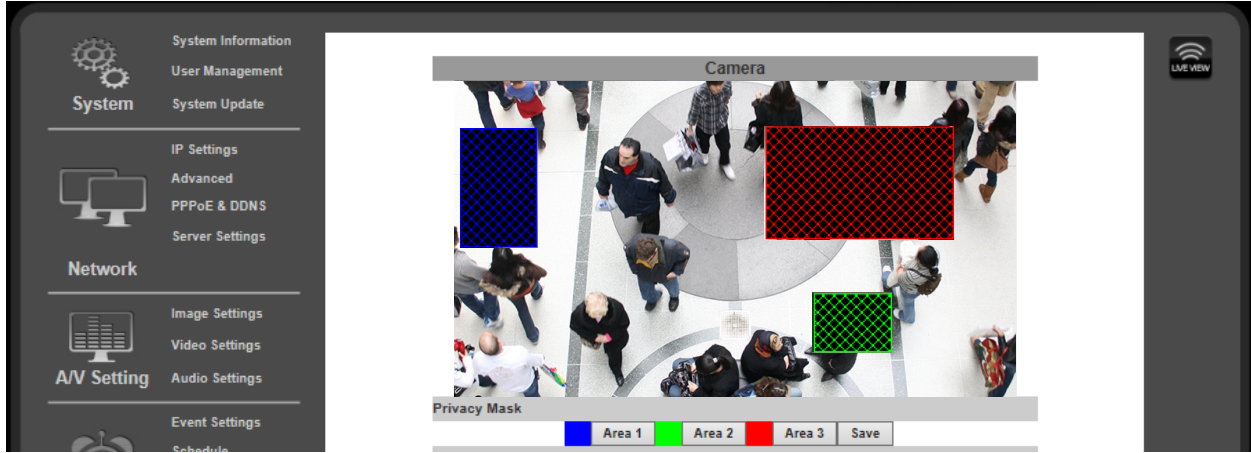

#### A. Assigning a Privacy Mask

1. Select Area 1 next to the blue box.
2. Place the mouse at the upper left hand corner of the area to mask, hold down the left mouse button and drag the box over the area to mask and release the mouse button. The area to be masked will be indicated by a colored grid.
3. Click Save to save the setting. The selected area will now display a black privacy mask under the colored grid, and this area will be blacked out in all viewed and recorded video.
4. Repeat for areas 2 & 3 if multiple privacy masks are required.

#### B. Removing a Privacy Mask

1. Select the button for the area to remove. The colored grid for the selected area will be removed.
2. Select Save to save the change. The black privacy mask will be removed.





### 10.4.3. Video Settings Menu Overview

The Camera supports up to four streams that can be used for streaming to a mobile device, network recorder, control system GUI, or the browser GUI simultaneously. While the highest quality is desired, it may not be supported by the network or device.



#### 10.4.3.1. Video Setting (For BNC Test Adapter Output)

<b>1</b>	<b>Video System</b>	Set the video system for the country of installation for PAL or NTSC. Default: NTSC
	<b>Corridor Mode</b>	Turn to “90” or “270” for a corrected aspect ratio if the camera is focused down a long hallway.
<b>Click “Apply” at the bottom right of the page to save modified settings.</b>		

#### 10.4.3.2. Streaming 1 and 2 Setting

- 2** Streams 1 and 2 are used for most streaming connections, including the web browser view, NVR's (uses both streams), and mobile app access. Stream 1 is set to the best quality that can be used for the camera for the given application.
- 3** External factors like network traffic or a slow Internet connection limit the quality. Stream 2 can be set to output a different stream type (H.264 or MJPEG) or to a lower quality setting. If a camera is accessed by a Wirepath™ NVR, Stream 2 will be forced open so that recording takes place. See section for complete overview and setup of streaming settings.

#### 10.4.3.3. Streaming 3 (JPG/MJPEG)

- 4** Stream 3 only outputs MJPEG format, primarily for use in automation systems that allow live camera views through touch panels. (Control4, Crestron, etc.) Frame Rate and Resolution settings are inherited from Stream 2. The compression may be changed for faster streaming from slow networks.

#### 10.4.3.4. Streaming 4 (3GPP)

- 5** (3rd Generation Partnership Project) Streaming for older phones. Limited resolution and frame rate for devices with very small amounts of memory or processor power.



### 10.4.4. Video Streaming 1 and 2 Setup

**Note:** Streaming 1 and 2 settings are identical. Settings options have only been covered once.

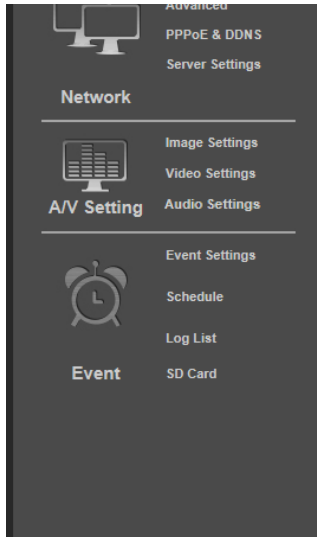

**Streaming 1 Setting**

Basic Mode  Advanced Mode

Resolution: 1280x800

Profile: Main

Bitrate Control Mode:  CBR  VBR

Video Quantitative: 9

Video Bitrate: 3Mbps

Video Frame Rate: 30 FPS

GOP Size: 1 X FPS GOP = 30

Video Format: H.264

RTSP Path: ex:rtsp://IP\_Address/ Audio:G.711

---

**Streaming 2 Setting**

Basic Mode  Advanced Mode  Close

Resolution: 640x480

Profile: Baseline

Bitrate Control Mode:  CBR  VBR

Video Quantitative: 7

Video Bitrate: 512Kbps

Video Frame Rate: 15 FPS

GOP Size: 1 X FPS GOP = 15

Video Format: H.264

RTSP Path: v2 ex:rtsp://IP\_Address/v2 Audio:G.711

<b>Basic/Advanced Mode</b>	Set the streaming mode to “Advanced” to allow fine control of streaming parameters. Extra options for Advanced mode are indicated below.	
<b>Resolution</b>	176x144 , 320x240, 640x480, 1280x720, 1920x1080 (default)	
<b>Profile</b>	<b>Main</b>	Main: This profile provides higher overall video quality and better video compression, which requires robust processing to decode in real-time. This profile should be used in conjunction with a Wirepath NVR or in stand-alone applications when maximum video quality is paramount.
	<b>Baseline</b>	Baseline: This profile provides slightly lower quality and less compression, making it easier for less-robust processors to decode in real-time. This profile may provide benefits in stand-alone applications without a Wirepath NVR, when camera will be configured primarily for non-HD resolutions, or when remote or mobile device access is a priority.
<b>Bitrate Control Mode</b>	<b>(Advanced Mode only)</b>	<b>CBR</b> – (Constant Bitrate) Bitrate of the image will remain constant regardless of image complexity. Provides a fixed, known bandwidth use.
		<b>VBR</b> – (Variable Bitrate) Bitrate of image increases and decreases based on image complexity. A higher quality image can be transmitted but during complex scenes bandwidth use increases.
<b>Video Quantitative</b>	<p>Changes the range of VBR bitrate to Low or High.</p> <ul style="list-style-type: none"> <li>In “Basic” mode, settings range from Low (slowest) - Medium - Standard - High - Best (fastest).</li> <li>In “Advanced” mode, quality may be set from 1 (slowest) to 9 (fastest).</li> </ul> <p>When this setting is changed, Bitrate Control Mode automatically changes to VBR, and the bitrate will increase or decrease depending on the select option.</p> <p><b><i>This setting will change if the camera is enabled or modified from a Wirepath™ NVR, since the NVR requires a CBR stream.</i></b></p>	
<b>Video Bitrate</b>	(Advanced Mode Only) Sets the fixed bitrate to use when CBR is selected for bitrate control. The recommend setting is 1, 2, 4, 6 or 8 Mbps for compatibility with Wirepath NVRs.	
<b>Video Frame Rate</b>	<p>Adjusts the bitrate from 5 FPS to 30 FPS for streaming 1, and from 5 FPS to 15 FPS for Streaming 2. Higher FPS (Frames Per Second) provides a smoother image but some display interfaces or devices may not be able to support the higher rate.</p> <p><b><i>Use the defaults 30 FPS (Streaming 1) and 15 FPS (Streaming 2) unless video display problems occur.</i></b></p>	



## Video Streaming 1 and 2 Setup, Continued

<b>GOP Size</b>	<p>GOP (Group of Pictures) is used to generate the visible frames of a video stream. The GOP size setting determines the multiplier to use for producing intermediate frames based on a standard of 15fps.          Example: 1/2x FPS=7.5fps    1x FPS=15fps    2x FPS=30fps</p> <p><b>Note:</b> Changing this setting will affect the performance of the stream. The highest setting (2X FPS) may result in saved video playback issues when Video Format is MPEG4 or MJPEG. We recommend that this setting is left at the default setting.</p>
<b>Video Format</b>	<p>While the default of H.264 is most efficient and will work in most cases; some devices that access Streaming 1 or Streaming 2 video streams may not support this format. For example, mobile devices, and automation system GUIs sometimes do not support H.264. Adjust the format to suit the system requirements and intended use of the streams.</p> <p><b>Available Formats</b></p> <ul style="list-style-type: none"> <li>• H.264</li> <li>• MJPEG</li> </ul>
<b>RTSP Path</b>	<p>Enter the name of RTSP (Real Time Streaming Protocol) path if RTSP has been configured.</p>
<p><b>Click “Apply” at the bottom right of the page to save modified settings.</b></p>	



### 10.4.5. Streaming 3 and 4 Setup

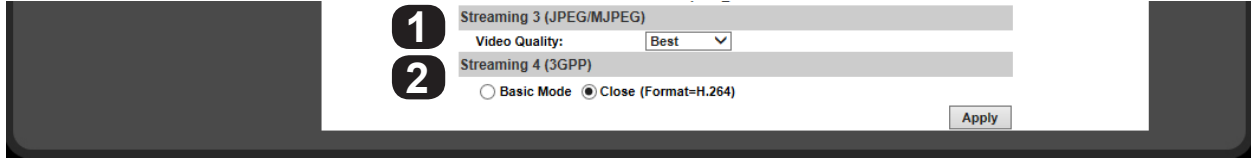

#### 10.4.5.1. Streaming 3

<b>1</b>	<b>Video Quality</b> Changes the video bitrate based on a level from Low (slowest) to Best (fastest).
Click “Apply” at the bottom right of the page to save modified settings.	

#### 10.4.5.2. Streaming 4

In “Close” mode, stream 4 defaults to h.264 only (settings will be inherited from Stream 2). Switch the setting to “Basic” mode to access more settings:

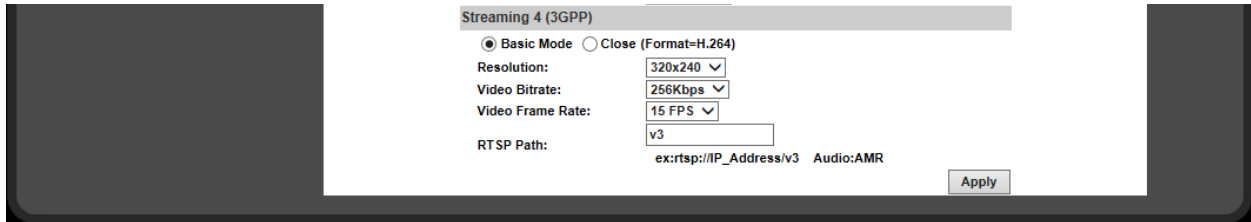

<b>2</b>	<b>Resolution</b> Sets the resolution for Stream 4. Select from 176x144 (lowest), 320x240 (default), or 640x480 (best).
	<b>Video Bitrate</b> Set the constant bitrate for Stream 4. Settings range from 32 Kbps (minimum) to 1 Mbps (maximum). Default: 256Kbps.
	<b>Video Frame Rate</b> Set the frames-per-second (FPS) rate for Stream 4. Select from 5 to 30 FPS. Default: 15 FPS.
	<b>RTSP Path</b> Enter the name of RTSP (Real Time Streaming Protocol) path if RTSP has been configured.
Click “Apply” at the bottom right of the page to save modified settings.	



## 10.4.6. Audio Settings

The camera supports two-way audio recording and playback. Record audio at the camera location using an external microphone, and hear it on PC's or smartphones viewing the live feed or playing back recorded footage. Connect the camera's audio output to an audio/speaker system input and send audio from the web browser or smartphone interface (device must be equipped with a microphone).

Some settings are not shown on the menu page by default since audio features are disabled (settings have been enabled below).

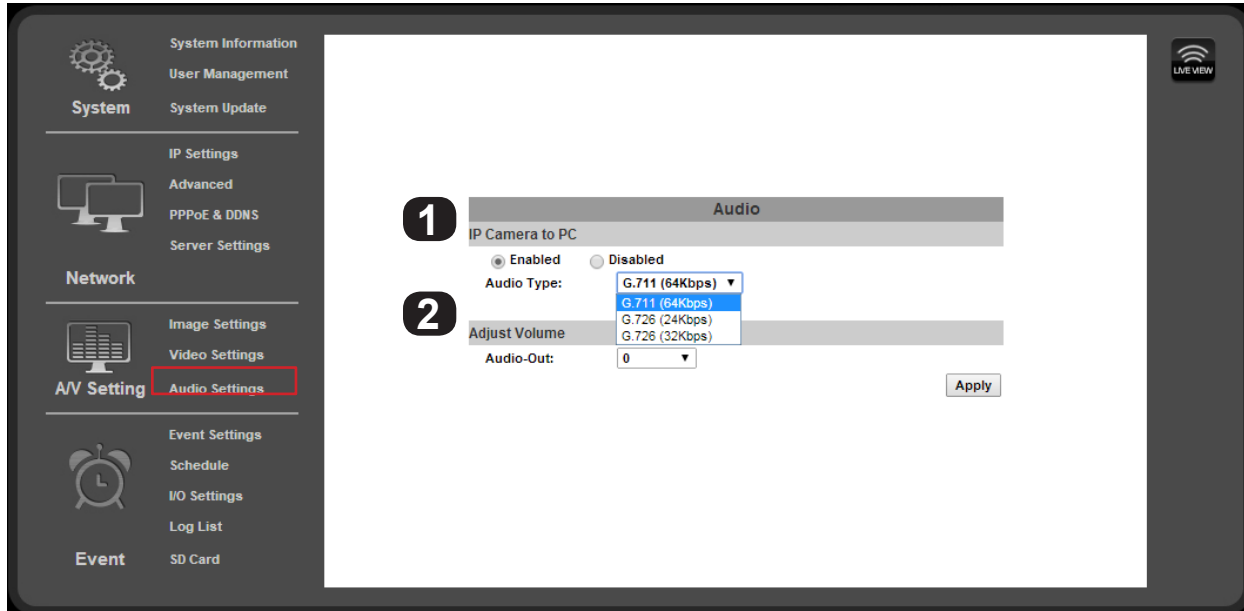

### 10.4.6.1. IP Camera to PC

<b>1</b>	<b>Enable/Disable</b>	Enable or disable audio features. Disabled by default.
	<b>Audio Type</b>	<p>Select the audio bit rate to use for streaming from the drop-down menu:</p> <ul style="list-style-type: none"> <li>• G.711 (64Kbps)</li> <li>• G.726 (24Kbps)</li> <li>• G.726 (32Kbps)</li> </ul> <p><i>Higher Kbps settings can increase audio quality but may cause audio to skip or cut-out on some networks. Use the lowest Kbps setting that provides adequate audio quality.</i></p>
<p><b>Click "Apply" at the bottom right of the Audio page to save modified settings.</b></p>		

### 10.4.6.2. Adjust Volume

<b>2</b>	<b>Mic-In</b>	Volume level adjustment for the Microphone input to the camera. Acts as an input trim level adjustment. Use the highest setting that does not cause distortion from the microphone.
	<b>Line-Out</b>	Volume level adjustment for Line output from the camera. Acts as an output gain adjustment. Use the lowest setting that will adequately drive an amplifier input without distortion.
<p><b>Click "Apply" at the bottom right of the Audio page to save modified settings.</b></p>		



### 10.4.7. Camera Audio Technology Overview

#### 10.4.7.1. How to Enable Audio Setup

Enable these settings ONLY if the features are being used, and only AFTER installation and connection of cameras and audio equipment.

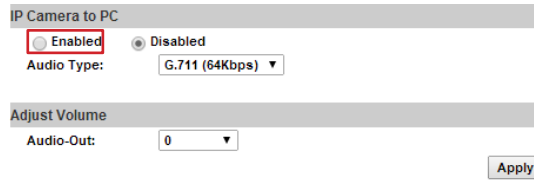
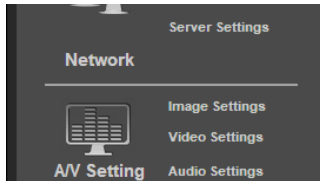

- A. Click the Enabled button from the top left of the menu under “IP Camera to PC” in the gray bar.
- B. Click Apply to reload the page with all settings enabled:

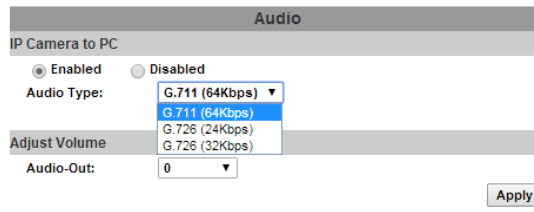
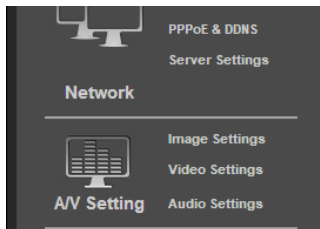

- C. Change the settings as needed. Click Apply in the bottom right of the screen to save the new settings.



## 10.5. Event Record Setup and Scheduling

Cameras can be set up to record on a set schedule, or in response to contact closure, motion or tampering. Set up how and when events are handled, including if and when to send an email notification or to send a file backup of an event to an off-site location. The log lists detail all camera events including record triggers, logins and settings changes.

### 10.5.1. Event Settings Menu

The screenshot displays the 'Event Settings' configuration page. On the left sidebar, the 'Event Settings' menu item is highlighted with a red box and a large '1' in a black circle. The main content area is titled 'Event Settings' and includes a 'Motion Detection' section with a video feed of a public area. Below the video, there are settings for three detection areas (Area 1, Area 2, Area 3) with sensitivity and notification options. Other sections include Record File, Record Time Setting, Network Disconnected, Network IP Check, and PIR Setting.

#### 1 Motion Detection

Up to 3 areas of a scene may be set up for detecting motion to trigger an action like recording video, taking a snapshot or series of snapshots, and/or sending email notifications to users. Detection may be toggled on and off by scheduling. Motion detection settings are detailed in a separate section: [9.5.2. Configuring Motion Detection Areas](#).

Continue to the next page for other menu descriptions.

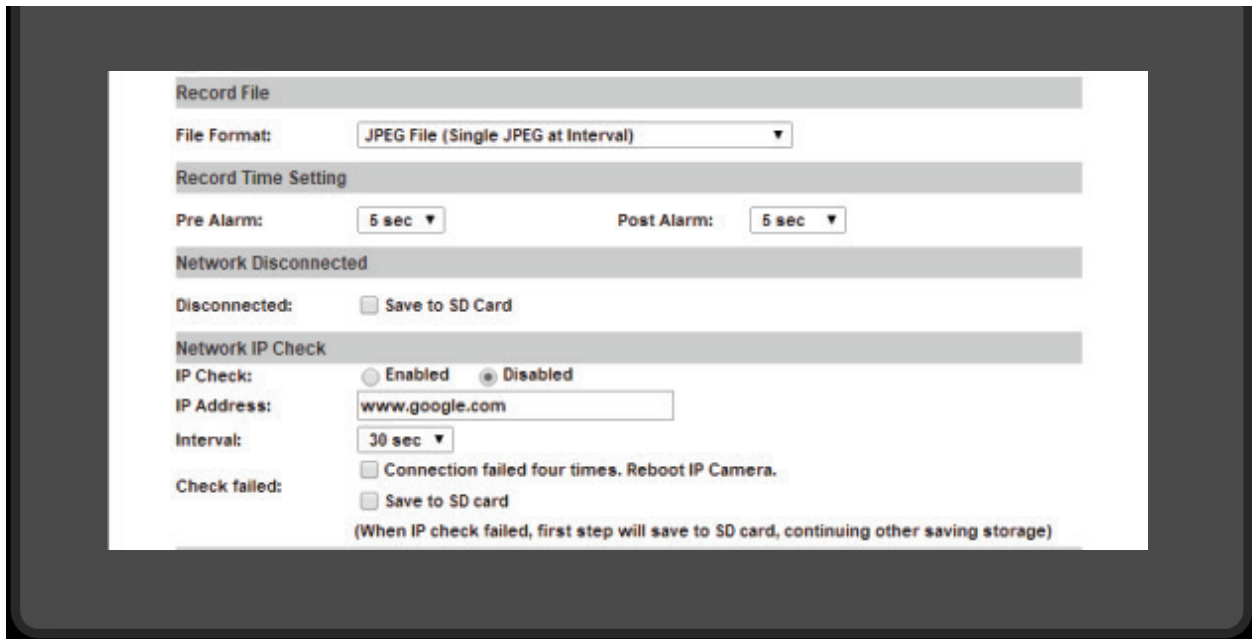

#### 10.5.1.1. Record File

**3**

<b>File Format</b>	<p>Selects the file type to create when the event occurs:</p> <ul style="list-style-type: none"> <li>• <b>AVI File</b> – Creates a short .AVI format video file.</li> <li>• <b>JPEG Files (Streaming 1 must be set MJPEG)</b> – Creates a series of JPEG files at about 1 FPS.</li> <li>• <b>JPEG File (Single JPEG at Interval)</b> – Creates a single JPEG image file at time of event.</li> </ul> <p><i>Note: JPEG Files (Streaming 1 Format must be MJPEG) saves or sends 10 JPEG images taken approximately 1 second apart. Video Settings / Streaming 1 Format <b>MUST</b> be set to MPEG in order to select this option.</i></p>
<p>Click "Apply" at the bottom right of the page to save modified settings.</p>	

#### 10.5.1.2. Record Time Setting

**4**

<b>Pre/Post Alarm</b>	<p><b>Pre Alarm</b> – Amount of time prior to the event to start the recording, from 0-5 seconds.</p> <p><b>Post Alarm</b> – Amount of time after to the event to stop the recording, from 0-10 seconds.</p> <p><i>Note: The camera cannot record intervals for motion events longer than 15 seconds in one video clip. Multiple recordings will be saved for motion events longer than the time set Motion Detection "Interval" section. In such cases there may be a gap of several seconds between recordings.</i></p>
<p>Click "Apply" at the bottom right of the page to save modified settings.</p>	

#### 10.5.1.3. Network Disconnected

**5**

<b>Disconnected</b>	<p>When checked, the camera will record event video to the microSD card (if installed) when the camera loses network connection.</p>
<p>Click "Apply" at the bottom right of the page to save modified settings.</p>	

#### 10.5.1.4. Network IP Check

**6**

<b>IP Check</b>	<p>When enabled, the Camera will periodically ping the address entered into the IP Address box below.</p>
<b>IP Address</b>	<p>Enter an IP Address or website URL to ping for checking connectivity.</p>
<b>Interval</b>	<p>Select the time between pings to the entered IP Address or URL.</p>
<b>Check Failed</b>	<p>Check "Connection failed four times..." to enable auto rebooting if the IP address does not respond after four attempts.</p> <p>Check "Save to SD Card" to save a log file to the microSD Card when the IP Address does not respond.</p>
<p>Click "Apply" at the bottom right of the page to save modified settings.</p>	





### 10.5.2. Configuring Motion Detection Areas

Motion detection allows for specific areas of the image to be used for triggering the recording of video, an alarm, or sending a notification. When an area is defined, motion in that area will trigger the predefined action; this is useful to avoid unwanted events from being triggered due to motion in areas of no concern.

#### 10.5.2.1. Motion Detection Settings Overview

<b>Area Setting</b>	Area Setting Select the button to set the area for detection.
<b>Sensitivity</b>	Adjustable from 1 (Requires higher amount of motion to trigger) to 10 (Requires low amount of motion to trigger).
<b>Area 1, 2, 3</b>	<ul style="list-style-type: none"> <li><b>Area #</b> - when selected the area is enabled allowing for the events defined below to occur.</li> <li><b>E-Mail</b> - check the box to send media via email. Requires configuration of Email Settings as defined in section <a href="#">10.3.8.2. Mail Settings</a>.</li> <li><b>FTP</b> - check the box to save media to an FTP site or server. Requires configuration of FTP as defined in section <a href="#">10.3.8.3. FTP Settings</a>.</li> <li><b>SD Card</b> - check the box to save media to a microSD card (if installed). See section <a href="#">10.7. SD Card Menu</a> for more information about microSD card setup and use.</li> <li><b>DO Out</b> - Check to activate the DO contact output to trigger a connected device contact input. Requires connection and configuration of DO output as defined in section <a href="#">7.3. Relay Connections</a>.</li> <li><b>Network Share</b> - check the box to save media to a Network Share location. Requires the configuration of Network Share as defined in section <a href="#">10.3.8.4. Network Share Settings</a>.</li> </ul>
<b>Subject</b>	Text to use as subject of email notifications when they are sent.
<b>Interval</b>	Selects the minimum time between motion events that the camera will respond to. Higher values are useful to reduce notifications for camera scenes with more expected motion.
<b>Only in Schedule Times</b>	When selected, motion events will only be triggered based on a configured schedule.
<b>Click "Apply" at the bottom right of the page to save modified settings.</b>	



### 10.5.2.2. Adding a New Motion Detection Area

- Select Event Setting under Event on the left side Menu.
- Select the Area for Motion Detection.
- Select Area 1 next to the blue box.
- Place the mouse at the upper left hand corner of the area to mask, hold down the left mouse button and drag the box over the area to mask and release the mouse button.

- Select the Sensitivity level in the drop down box under the Area. (Range 1 Low to 10 High).
- Select the check box next to the area and select the type of Events to perform when motion is detected in that area.
- Select a Name to use for the Subject line of email notifications.
- Set the Interval between motion events (the minimum time to wait before triggering subsequent motion events).
- Repeat Steps A-H for Areas 2 & 3 if more areas are needed.
- Set the Delivery Media Format.
- Select the File Format from the dropdown list.
- Select the time to Start and Stop the recording.
- Select Action to Perform when Connection is Lost.
- Select Apply at the bottom of the screen to save the settings.

### 10.5.2.3. Removing a Motion Detection Area

- Select the button for the area to remove. The colored grid for the selected area will be removed.
- Click "Save" to save the change.



### 10.5.3. Schedule Menu

Use this menu to configure a schedule for capturing images from the camera to be stored.

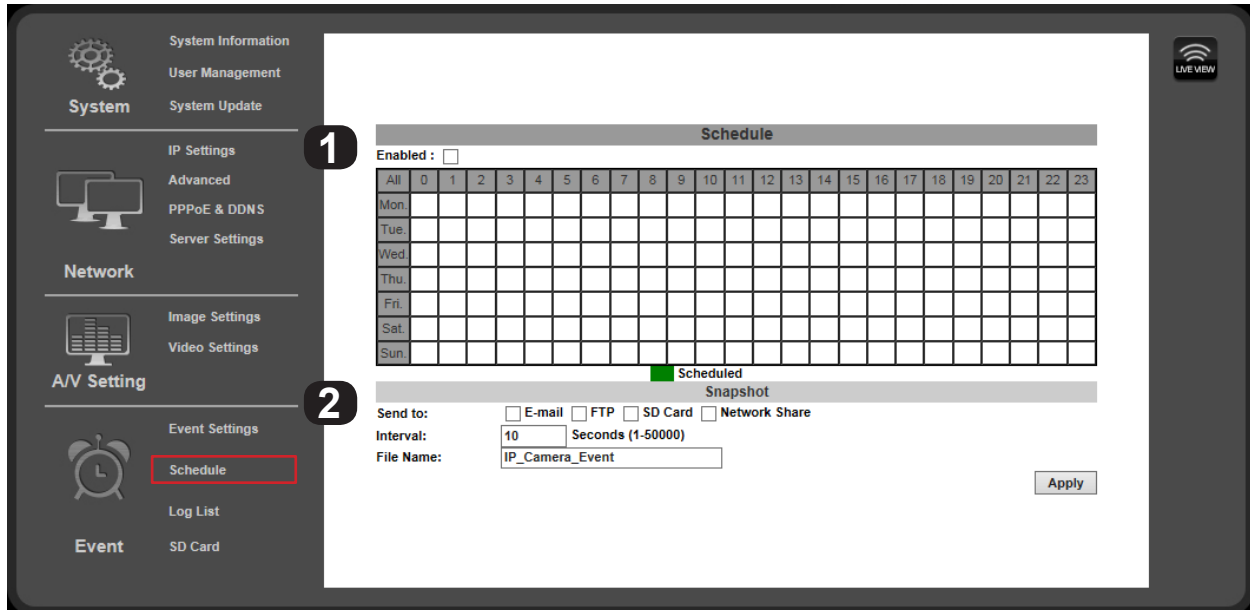

**1**

**Enable** Check box to Enable Scheduling feature.

**Schedule**

Grid with Days of the Week and Time of day for snapshots to be recorded. Enabled dates and time appear as a Green box.

**NOTE:** This Schedule can also act to provide days/times when motion Events are allowed to send notifications and send or save media. See Only in Schedule times in section .

Click "Apply" at the bottom right of the page to save modified settings.

#### 10.5.3.1. Snapshot Menu

**2**

**Send To**

Select the method used to send or save JPEG snapshots based on the schedule defined above. Available options include Email, FTP, SD Card and Network Share.

**Interval**

Sets the interval between the snapshots for the scheduled day. Example: when set to 60 seconds, a snapshot will be sent or saved every 60 seconds.

**File Name**

Enter a name to use to identify the snapshot files. Use this menu to configure the Cameras Contact & Relay connections.

Click "Apply" at the bottom right of the page to save modified settings.



### 10.5.3.2. How to Set Up Scheduling for Events

- A. Select Schedule under Event on the left side Menu.
- B. Select the Enabled check box.
- C. Click on the box(es) to enable one-hour blocks of time for the desired Day of week and Time of day.

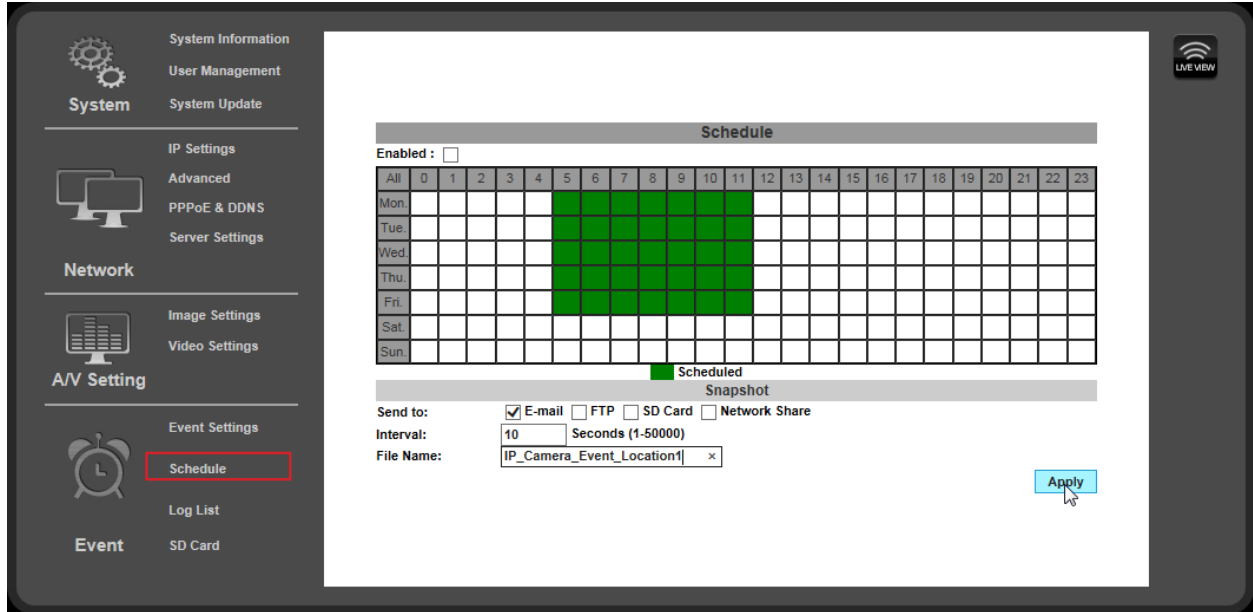

### 10.5.3.3. Set up Snapshot

- A. In the Snapshot section, select the delivery method for the Snapshot.
- B. Select an Interval between the Snapshots for the selected periods.  
Example: when set to 60 seconds, a snapshot will be sent to the selected destinations every 60 seconds.
- C. Select a Filename to identify the Snapshot.
- D. Select Apply at the bottom of the screen to save the settings.



## 10.5.4. I/O Settings

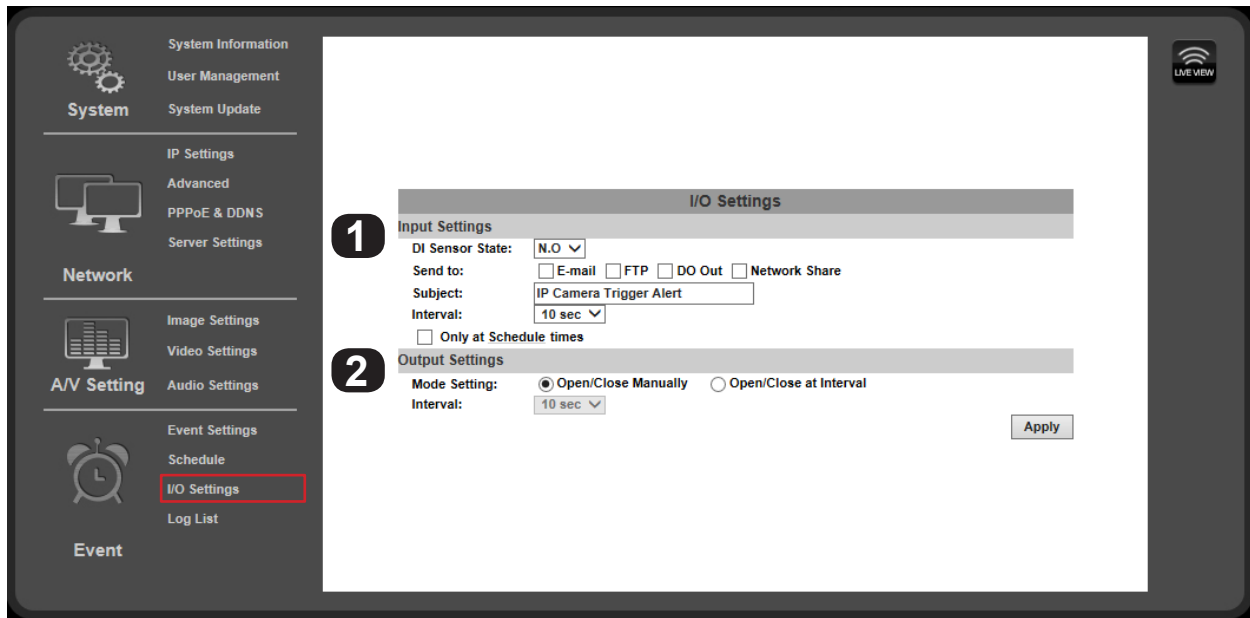

### 10.5.4.1. Input Settings

**1**

<b>DI Sensor State</b>	N.O Camera expects contact closure connected to the DI input to be normally Open. Event is triggered when the contact is closed. N.C Camera expects contact closure connected to the DI input to be normally Closed. Event is triggered when the contact is open.
<b>Send To</b>	If notification or logging is desired, select the destination to send it to when the DI input event is triggered.
<b>Subject</b>	Enter a name to use to identify the event.
<b>Interval</b>	Select the time to wait between input events before another event can be triggered.
<b>Only at Schedule Times</b>	When selected, events will only be monitored based on a configured schedule. Scheduling must be enabled for this feature to work.
<b>Click "Apply" at the bottom right of the I/O Settings page to save modified settings.</b>	

### 10.5.4.2. Output Settings

**2**

<b>Mode Setting</b>	Open/Close Manually Device connected to the DO output can be triggered from the browser GUI or configured Events only. Open/Close at Interval DO output will be cycled between Open and Closed at the Interval configured below.
<b>Interval</b>	Select the interval between DO output Open and Close when Mode Setting is "Open/Close at Interval".
<b>Click "Apply" at the bottom right of the I/O Settings page to save modified settings.</b>	



## 10.6. Log List

The camera software stores a log file for several parameters in the camera. Use the Log List menu to select a log to view.

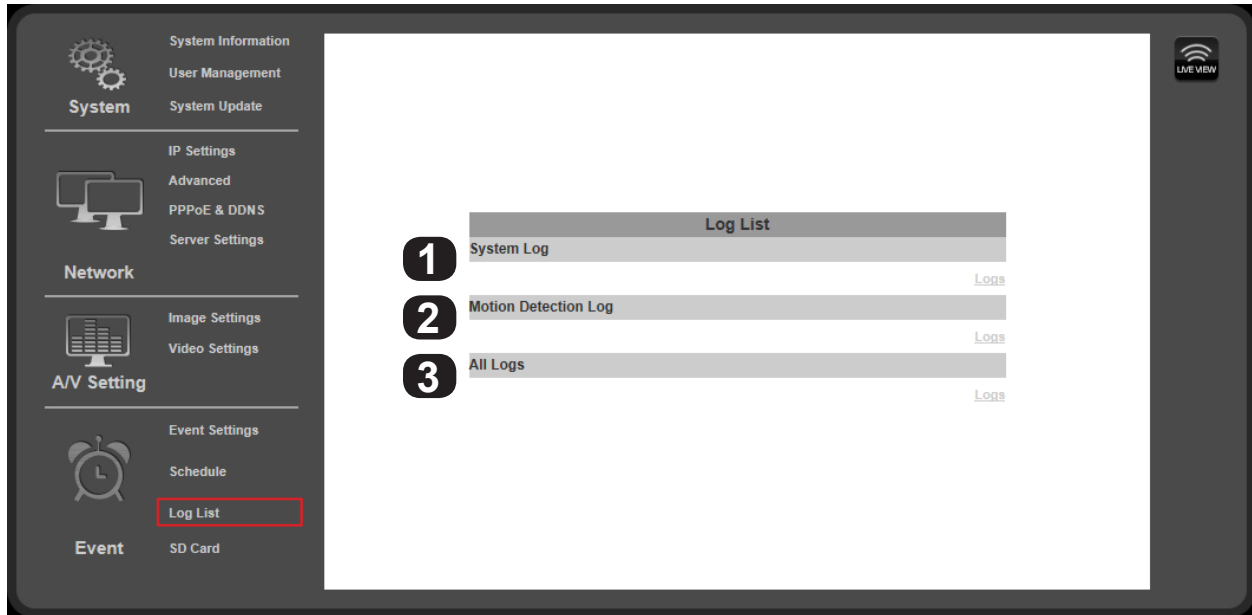

### System Log

- 1** Displays System events such as logins and configuration changes. This log is maintained even through loss of power.  
Click “Logs” to open and view the log file in a new browser window.

#### 10.6.4.1. Motion Detection Log

- 2** Displays Motion Detection events. This log is NOT maintained when power is lost.  
Click “Logs” to open and view the log file in a new browser window.

#### 10.6.4.2. All Logs

- 3** Displays a list of all log entries from the three individual logs.  
Click “Logs” to open and view the log file in a new browser window.



## 10.7. SD Card Menu

Use this menu to set up and access a microSD card.

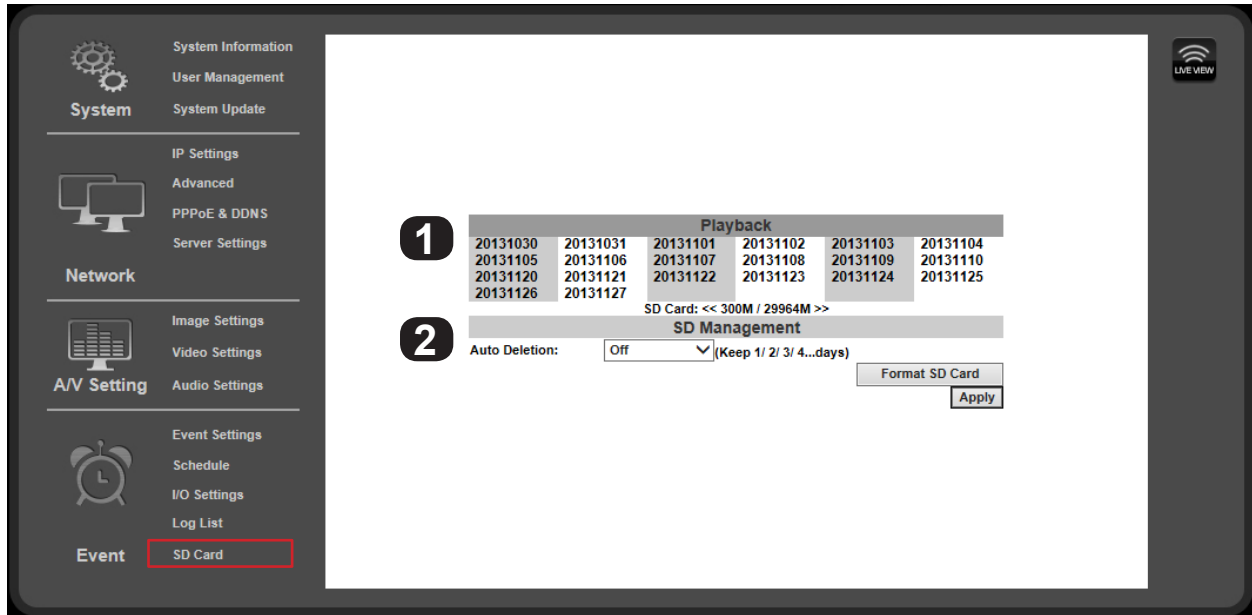

### 10.7.1. Playback

1

This area will display “No SD Card” when no microSD card is installed. When a compatible card is installed and the card contains media, folder names are displayed using the dates when media was saved as titles. Selecting a folder name displays the folder contents. File names are displayed in gray. If there are more than 10 files, additional pages can be selected below the file list.

Right clicking a file name allows the file to be Saved or Saved As to your PC.

“SD Card:” displays the total size and available space of the installed microSD card.

### 10.7.2. SD Management

2

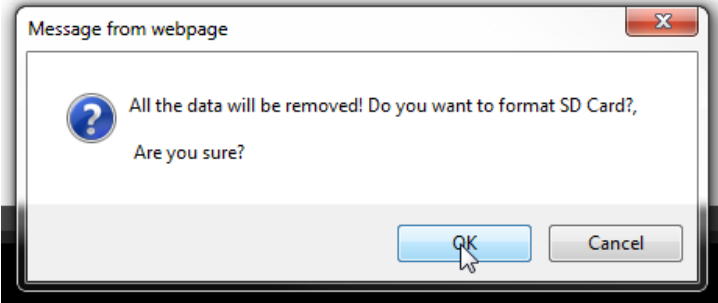
<b>Auto Deletion</b>	Select the method used to send or save JPEG snapshots based on the schedule defined above. Available options include Email, FTP, SD Card and Network Share.
<b>Interval</b>	<p><b>Off</b> - No data on the SD Card will be deleted by the camera. If the microSD card becomes full, no further data can be recorded.</p> <p><b>1st to 30th Day</b> Set the number of days worth of footage to keep on the memory card.</p> <p><b>Data older than the selected number of days will be deleted.</b></p>
<b>Format SD Card</b>	<p>Click to format the SD card, then click “OK” in the dialog box that appears:</p> 

Click “Apply” at the bottom right of the page to save modified settings.



## 11. Internal Heater Overview

This IP camera is equipped with an internal heating element that is programmed to turn on as needed based on ambient temperature. If temperatures fall below 23°F for an extended period, the internal heater will turn on to keep the iris operating correctly. Without this feature, the iris could become so cold that it sticks in place, causing the camera to lose picture. Once temperatures rise back above 59°F, the heater will turn off to save power.

Temperature	Operating Behavior
<b>23°F (-5°C) or lower</b>	Heater will turn on to protect camera
<b>-40°F (-40°C) or lower</b>	Camera should be powered off to protect internals. Keep the camera off until temperature rises to a safe range.
<b>59°F (15°C)-113°F (45°C)</b>	Heater will turn back off.
<b>Over 113°F (45°C)</b>	Camera should be powered off to protect internals. Keep the camera off until temperature falls to a safe range.

### 11.1. Safe Operating Range

- **-40°F ~ 113°F (-20°C ~ 45°C)**
  - **If the ambient temperature is between these temperatures, the camera should power up and operate normally.**
  - **If temperatures remain above or below the safe operating range, the camera will shut off or will not power on to avoid damage to the internals.**





## 12. Reset Procedure

If the camera ever becomes unresponsive after an update, or Administrator access is lost, it may be necessary to manually reset the camera back to default configuration. The procedure was designed to require significant effort so that resets could not easily be done with malicious intent. For this reason, it may be necessary to remove the camera to do the reset unless an assistant can help.

**Warning! Resetting the camera erases ALL settings, including IP and user/admin settings. Use the IP Installer software to rediscover the camera on the network after the reset. The IP address will return to DHCP.**

**Important! You must have direct access to the camera and its power source to reset the firmware. Have a way of reaching the camera. Have an assistant to help control power, or remove the camera to perform the reset.**

- A. Remove power to the camera at the power supply location or by disconnecting the network cable from the network (if using PoE power).
- B. Open the camera dome and rotate the gimbal so the small black momentary switch on the board is accessible:
- C. To perform the reset, the button must be pressed and held for 30 seconds while power is applied. The button must remain pressed for the entire 30 seconds.
- D. After 30 seconds, release the button. The camera will boot up as normal and can be discovered on the network again using the IP Installer software.

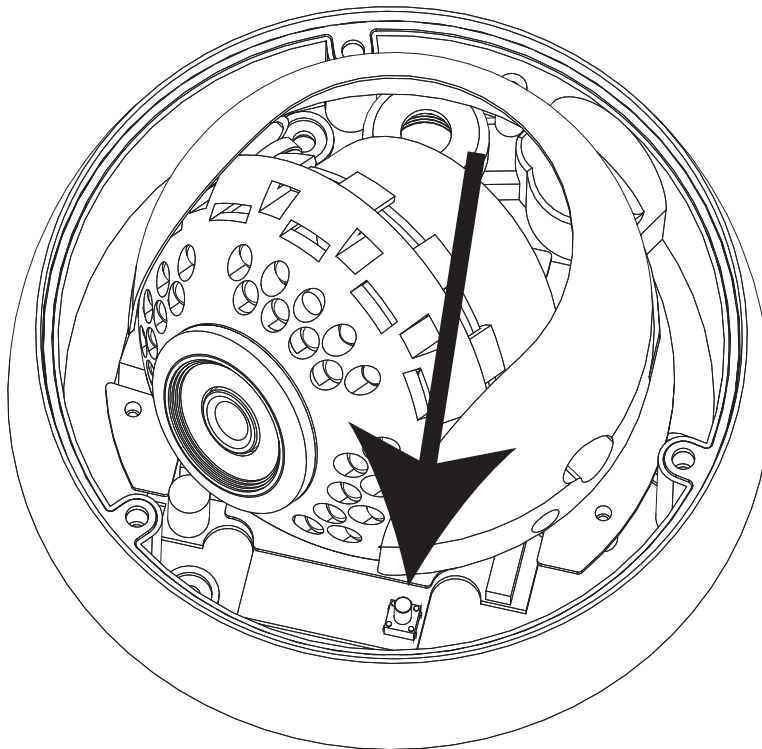

## 13. Mobile App Access

Use your computer, or **FREE** iPhone®, native iPad®, or Android® smartphone apps to view cameras while at the office or on the go. Details on setup and operation can be found at [www.SnapAV.com](http://www.SnapAV.com).



## 14. Specifications

Imaging	
Image Sensor	1/2.7" 2MP CMOS sensor
Lens Type	Varifocal 3~10.5mm Mega Pixel Lens F1.4
View Angle	103.73°(H) 54.43°(V)
Video Resolution	1920x1080@30fps, 1280x720@30fps, 640x480@30fps, 320x240@30fps, 176x144@30fps
Minimum Illumination	0.05 lux @F1.4 (IR off)
	0 lux @F1.4 (IR on)
DC Iris	Yes
Shutter Speed	1/5~1/1000
True Day/ Night (IR Cut Filter)	Yes
IR Distance-	50 ft
Digital WDR	Yes
DNR	Yes
Sense Up	Yes
AGC	Yes
Lens Distortion Correction	Yes
Anti-Fog	Yes
Input/Output Ports	
Video Test Port	Yes
Setup Power Port	Yes
On Pigtail	1 Digital in and 1 Digital out (3pin Green Socket), DC-jack, 1 Audio in and 1 Audio out, male RJ45
Audio	
Audio Compression	G.711(64K) and G.726(32K,24K) audio compression
Audio Input	3.5mm x 1
Audio Output	3.5mm x 1
Network	
Ethernet	10/100 Base-T
Network Protocol	HTTP, HTTPS, SNMP, QoS/DSCP, Access list, RTSP, TCP/ IP, UDP, SMTP, FTP, PPPoE, DHCP, DDNS, NTP, UPnP, 3GPP, SAMBA, Bonjour
Technology	
Video Adjust	Brightness, Contrast, Hue, Saturation, Sharpness, Shutter Speed adjustable, AGC, Sense-Up, D-WDR, Flip, Mirror, Noise reduction, Day&Night adjustable
Quad Streaming	Yes
Image Snapshot	Yes
Full Screen Monitoring	Yes
Privacy Mask	Yes
Compression Format	H.264/ M-JPEG
Video Bitrates	Constant (CBR), and Variable (VBR)
Motion Detection	Yes
Actions Upon Triggers	Email FTP Save to micro SD card SAMBA Digital Output
Pre/ Post Alarm	Yes



<b>Security and QoS</b>	Password protection, IP address filtering, HTTPS encrypted data transmission, QoS/DSCP
<b>Simultaneous Connections / Users</b>	Up to 10
<b>SD Card Management</b>	Yes
<b>Recording Triggers</b>	Motion Detection IP Ping failure Network disconnect Schedule Digital Input
<b>Video Format</b>	AVI, JPEG
<b>Video Playback</b>	Yes
<b>Housing &amp; Power</b>	
<b>Operating Temperature</b>	-40 to 113°F
<b>Vandal Resistance</b>	Yes
<b>Side Conduit Threading</b>	'3/4' NTP
<b>Weight</b>	2.18 lbs
<b>Weather Rating</b>	IP66
<b>POE / Consumption</b>	Yes - PoE IEEE 802.3af 80mA 3.83W(IR off Heater off) 110mA 5.28W(IR on Heater off) 160mA 7.68W(IR off Heater on) 190mA 9.12W(IR on Heater on)
<b>12VDC Power Consumption</b>	230mA 2.76W(IR off Heater off) 360mA 4.32W(IR on Heater off) 520mA 6.24W(IR off Heater on) 650mA 7.8W(IR on Heater on)
<b>Certifications</b>	
<b>Onvif</b>	Yes
<b>CE, FCC, RoHS</b>	Yes
<b>Client System Requirements</b>	
<b>OS</b>	Windows 7, Microsoft IE 11.0 or above
<b>Mobile Support</b>	iOS 4.3 or above, Android 2.3 or above
<b>Suggested Hardware</b>	Intel Dual Core 2.53G, RAM: 1024MB, Graphic card: 128MB
<b>Minimum Hardware</b>	Intel-C 2.8G, RAM: 512MB, Graphic card: 64MB



## 15. Dimensions

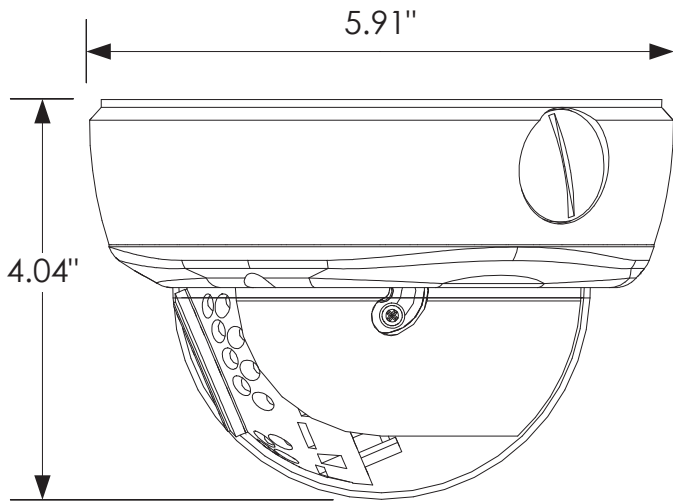

Side View

Maximum Camera Angle

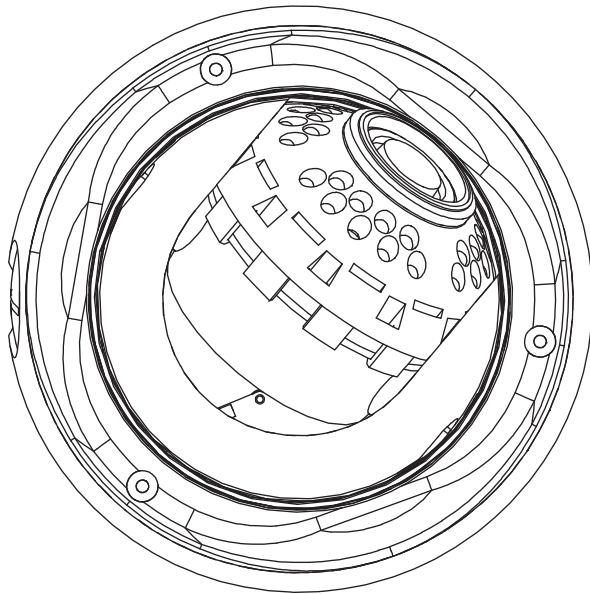
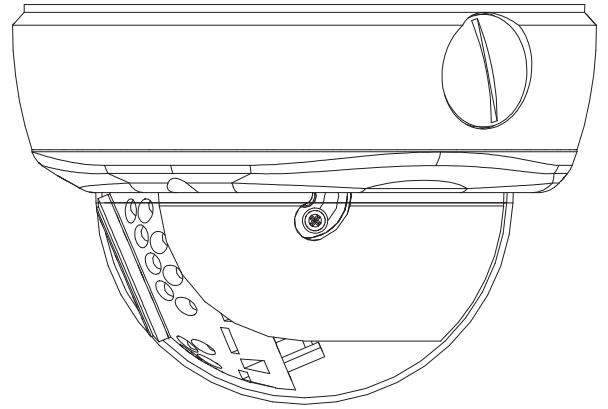

Top View

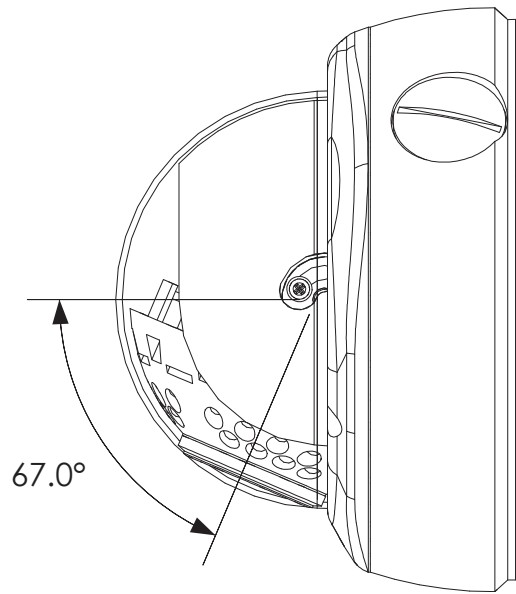



## 16. Warranty

### 3-Year Limited Warranty

This Camera has a 3-Year Limited Warranty. The warranty includes parts and labor repairs on all components found to be defective in material or workmanship under normal conditions of use. This warranty shall not apply to products that have been abused, modified, disassembled, or improperly installed. Products to be repaired under this warranty must be returned to Wirepath™ Surveillance or a designated service center with prior notification and an assigned return authorization number (RA).

## 17. Contacting Technical Support

Phone Number	(866) 838-5052
Email	<a href="mailto:TechSupport@SnapAV.com">TechSupport@SnapAV.com</a>

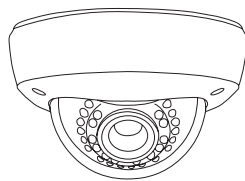

# WIREPATH SURVEILLANCE

© 2014 Wirepath™ Surveillance

140826-1430