



MM540 Enhanced Pull Down TV Mount

Easily pull a large flat screen TV down and off the wall for optimal eye-level viewing!

The MM540 Enhanced Mount offers our full range of motion, safety, reliability, incomparable engineering & craftsmanship that you can only find in a MantelMount® Pull Down TV Mount.

Features include: Heat-sensing handles, built-in sound bar attachment, paintable wall covers, 27" vertical travel, 30° swivel left and right or 60° swivel in one direction, cable management, adjustable stops, auto-straightening and an adjustable 9° tilt.

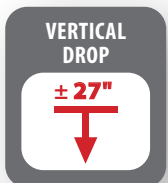
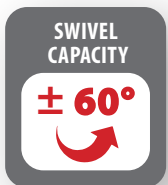
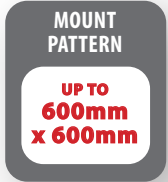
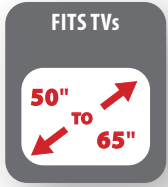
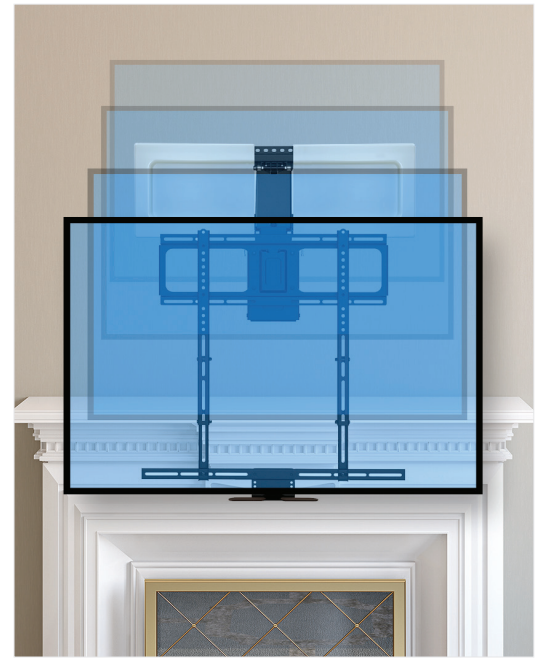

Problematic View

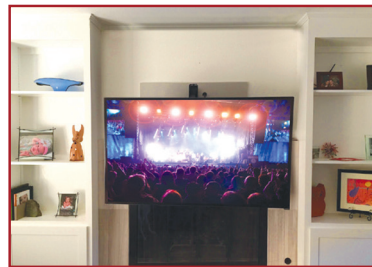

Perfected View with the MantelMount 540

- **TWO AUTOMOTIVE GAS PISTONS**
Makes TV feel feather light.
- **PAINTABLE WALL COVERS**
Conceals the TV mount's wall hardware
- **HEAT SENSING HANDLES**
Handles turn red if the temperature reaches 110°
- **PATENTED AUTO STRAIGHTENING**
Automatically aligns TV when lifted to it's highest position
- **ENHANCED STABILIZATION** (Patent Pending) Maintains a level TV over time.
- **CABLE MANAGEMENT**
Tabs keep TV wires organized.
- **HARD TRAVEL-LIMIT STOPS**
Manually set vertical and horizontal travel stops to assure your TV doesn't hit your mantel or wall.
- **BUILT-IN SOUND BAR ADAPTER**
No additional hardware required.

5 Five-year limited consumer warranty included.

All necessary hardware is in the box.

MantelMount. MM540

U.S. PATENT NO. 8,864092

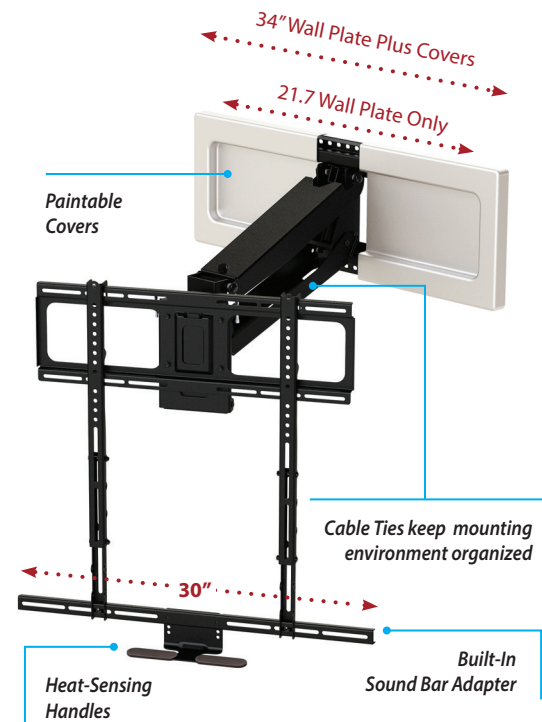

MM540 Specifications

TV Size	50" – 65" up to 90 lbs.
Mount Weight	29 lbs.
Dimensions	34" w x 25" h x 8.25" d
UPC Code	861709000360
UMAP	\$299.00



www.MantelMountPro.com
contact@mantelmount.com 800.897.9755