

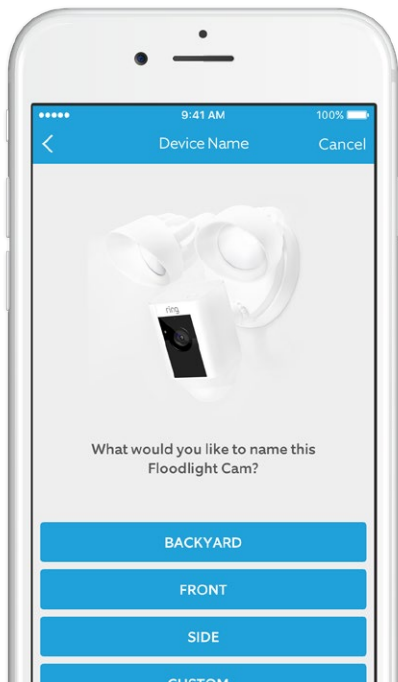

ring

Floodlight Cam



Smart Security at Every Corner of Your Home

Your new Ring Floodlight Cam lets you extend the Ring of Security around your entire property.

Now, you'll always be the first to know when someone's in your yard, and you can watch over your home from anywhere.

Monitor your home, prevent crime and protect your property – all from your phone, tablet or PC.

This manual is for informational purposes only. Working with electricity can be dangerous unless proper safety precautions are taken. If you are not comfortable or are inexperienced with the processes and tools described in this manual, we recommend that you hire a licensed electrician. If you are outside of North America, installation and wiring must be performed by a licensed electrician.

Before you begin

Check out all the stuff in the box.



Screwdriver

Use the screwdriver handle to tighten the cap nuts.



Phillips Bit

Use the Phillips bit for installing the mounting bracket.

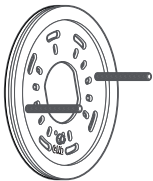

Mounting Bracket

Use this bracket to attach to your junction box to secure your Floodlight Cam.

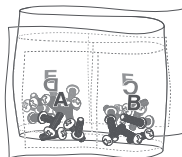

Bag o' Screws

Find the right ones to attach the mounting bracket to your junction box without running to the hardware store.



Wire Nuts (3)

Use these to connect Floodlight Cam's wires to your existing wires.



Screw Cap Nuts (3)

Use these to secure your Floodlight Cam to the posts on the mounting bracket to complete the installation.



Hook

Hang your Floodlight Cam while connecting the wires.

How it all fits together

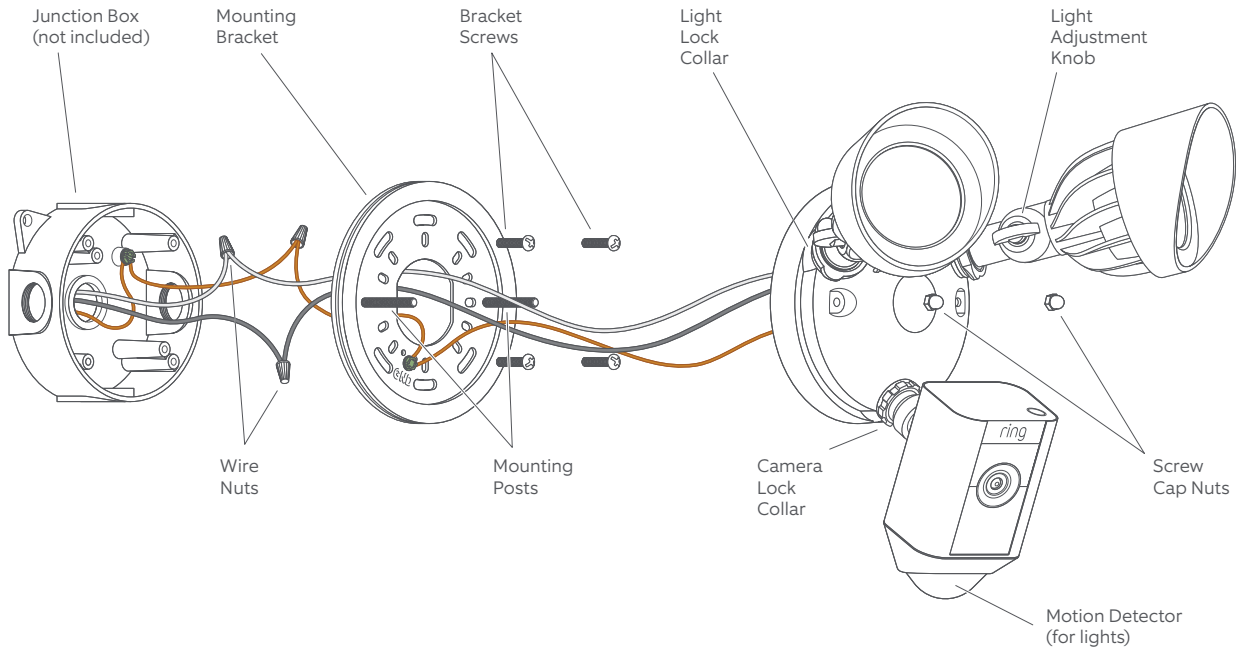

How installation height affects motion detection

When mounted at 9 feet off the ground, with the motion detector parallel to the ground, the motion sensor is optimized to detect human-sized objects at up to 30 feet.

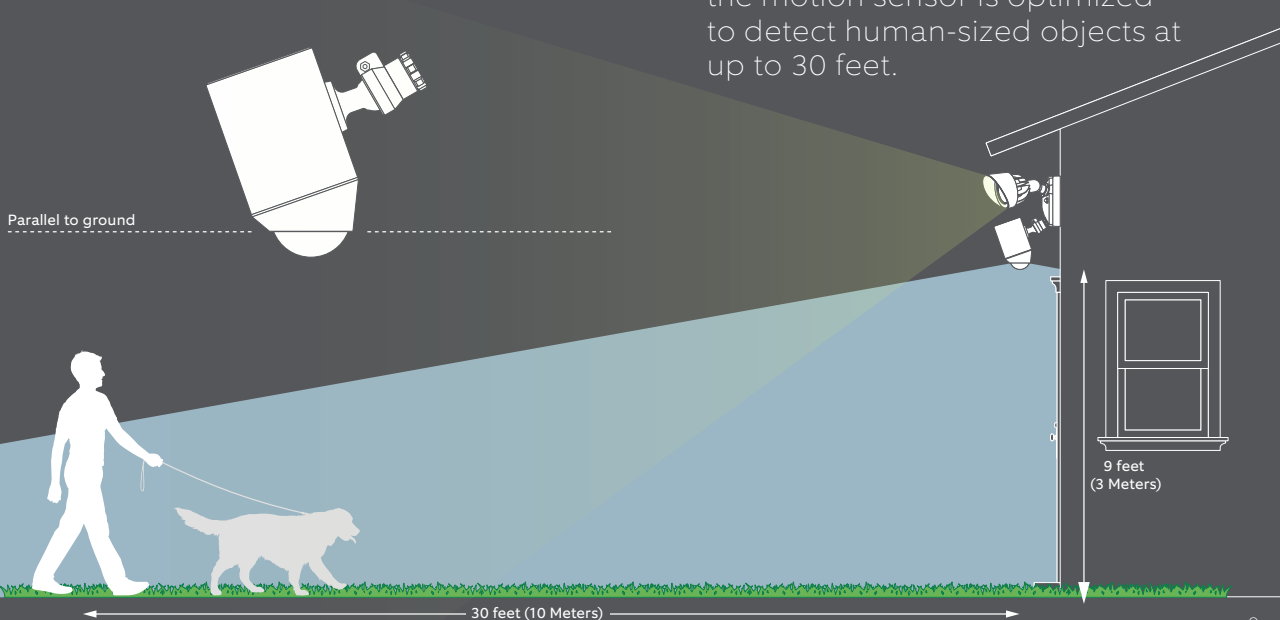

Shut power off at the breaker

If you don't know where your breaker is or how to turn off power to your floodlight circuit, consult with a licensed electrician.



WARNING: Risk of electrical shock

- Disconnect power at the fuse or circuit breaker before installing.
- Verify that the supply voltage is correct. Connect fixture to a 100 VAC~240 VAC 50/60 Hz power source.

- Properly ground fixture.
- Always follow code standards when installing wired connections.
- If you are outside of North America, installation and wiring must be performed by a licensed electrician.

CAUTION: Risk of fire

- Do not install near combustible or flammable surfaces.

NOTICE

- Do not connect this light fixture to a dimmer switch or timer.
- Floodlight Cam must be installed on a wall and on a UL listed junction box.



Prep your Floodlight Cam for installation

- A** Loosen the knobs on the light fixtures to rotate them out of the way and allow access to the mounting screws.

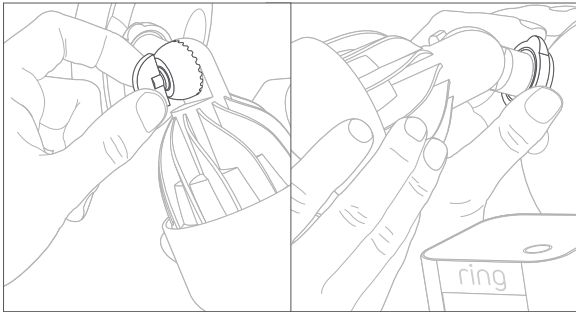

Do not remove your Floodlight Cam from the ball socket on the base.

- B** Rotate the camera 180 degrees since Floodlight Cam ships with the camera upside down on the fixture.

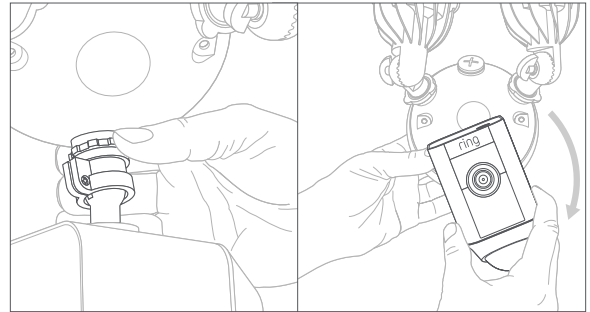

Remove your existing floodlight

- A** With power off at the breaker, remove your existing floodlight from the junction box it's attached to and disconnect the wires.
- B** If there is a bracket attached to your junction box, remove that as well.

Inspect your junction box to make sure water cannot get into it.

Floodlight Cam must be installed on a UL listed junction box. If you don't have an existing junction box, you'll need to hire a licensed electrician to install one. Also, be sure to comply with your local building codes.

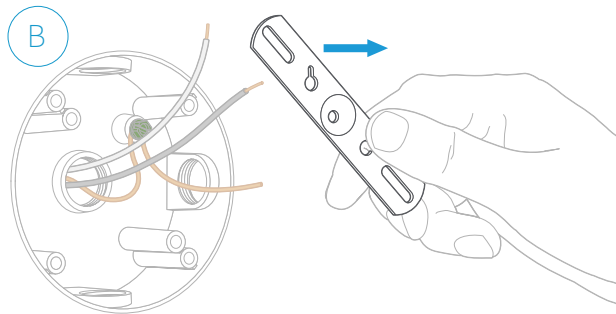
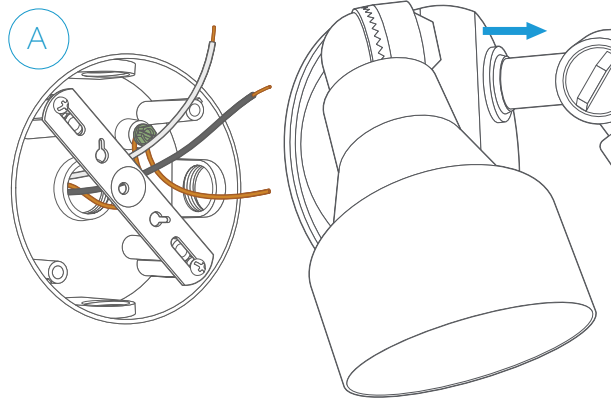

Install the mounting bracket

Install the mounting bracket on your wall with the two posts level with the ground.

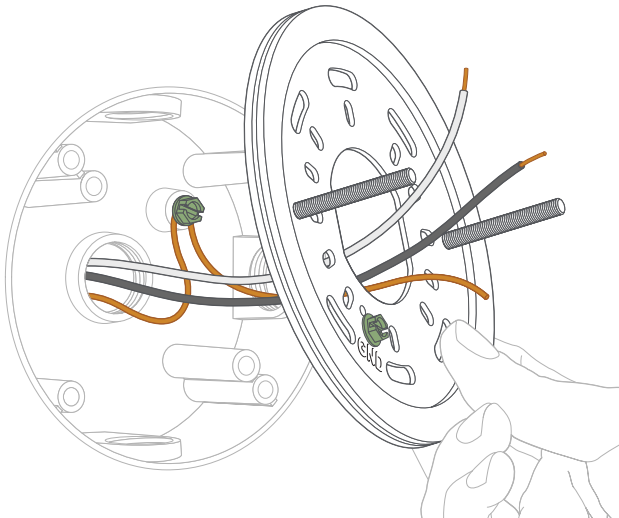

Make sure your existing wires come through the middle of the bracket.

Attach the bracket to your junction box using at least two screws.

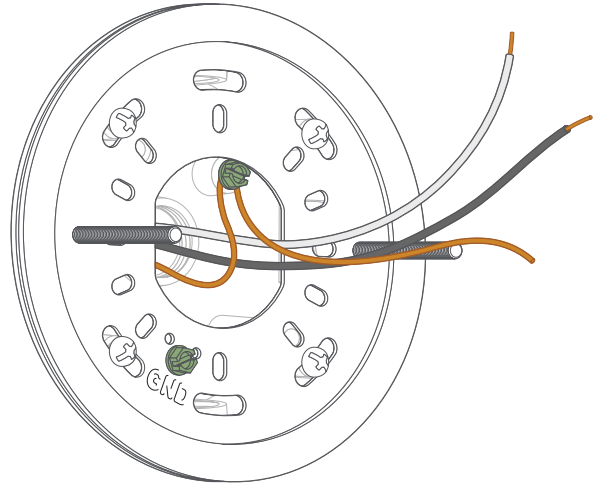

Hang Floodlight Cam

Use the provided hook to hang Floodlight Cam from the bracket while connecting the wires.

- A Hook one end of the provided hook into one of the mounting holes on your Floodlight Cam.
- B Hook the other end into one of the holes in the bracket.

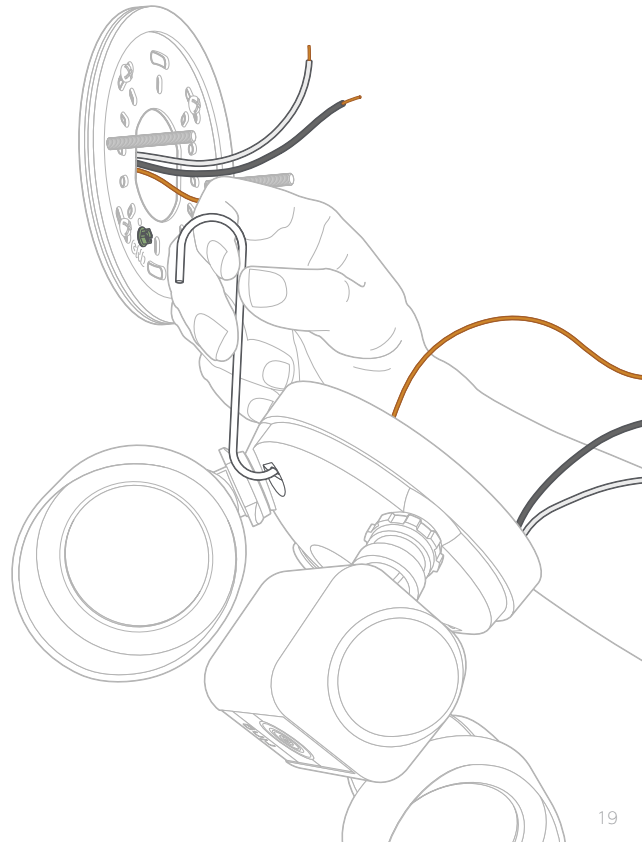

Connect the ground wire

The copper wire from Floodlight Cam is a ground.

Connect the ground wire to the green ground screw on the bracket **and** the existing ground wire inside your junction box.

Use one of the supplied wire nuts if necessary.

For safety and the proper operation of your Ring Floodlight Cam, the fixture must be properly grounded. If you're not familiar with the methods for properly grounding this type of fixture, consult a licensed electrician.

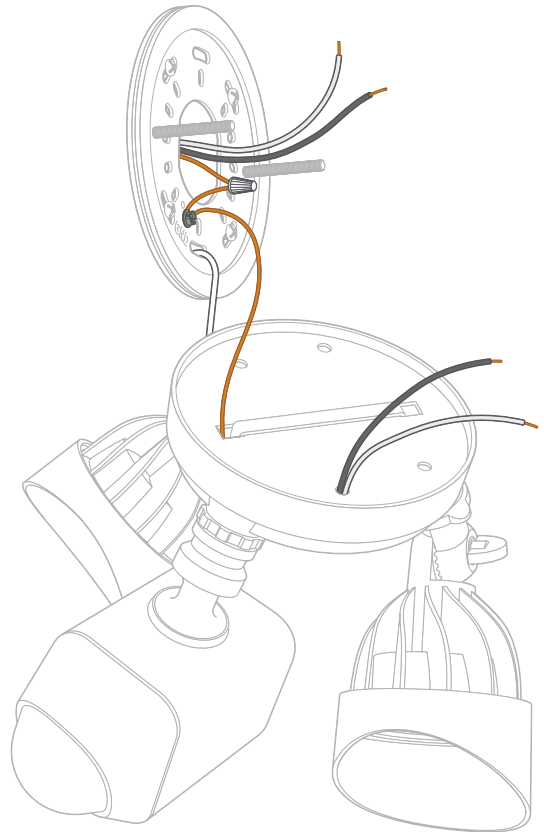

Connect the power wires

The white wire on Floodlight Cam is a **neutral wire**. Use a wire nut to connect this wire to the white (or neutral) wire coming out of your junction box.

The black wire from Floodlight Cam is a **hot wire**. Connect this wire to the black (or hot) wire coming out of your junction box using another wire nut.

If you don't have clearly colored black and white wires coming out of your junction box, consult with a licensed electrician.

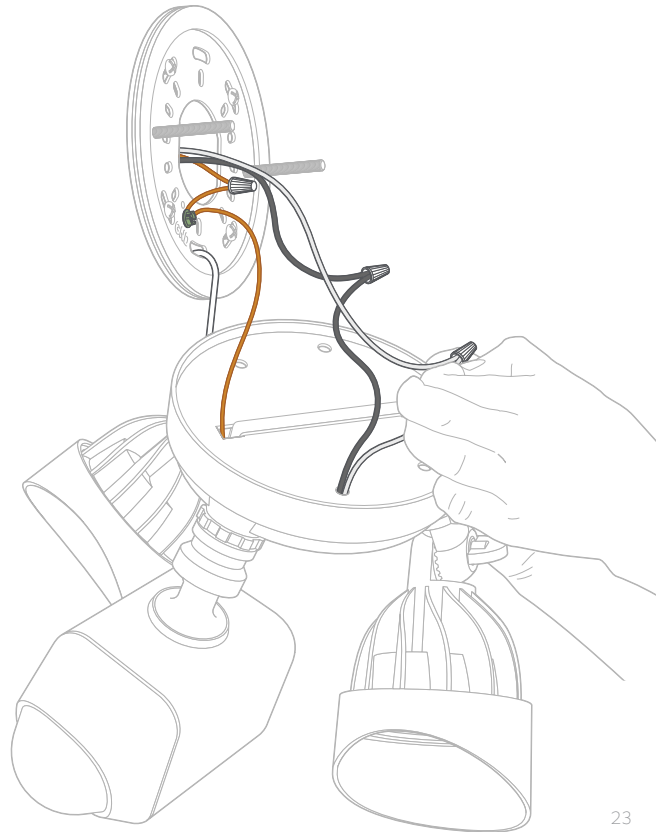

Place Floodlight Cam on the bracket

Carefully push all the wires through the large opening in the bracket.

Align the mounting posts with the holes on Floodlight Cam and press together, securing the screw cap nuts with the orange screwdriver handle.

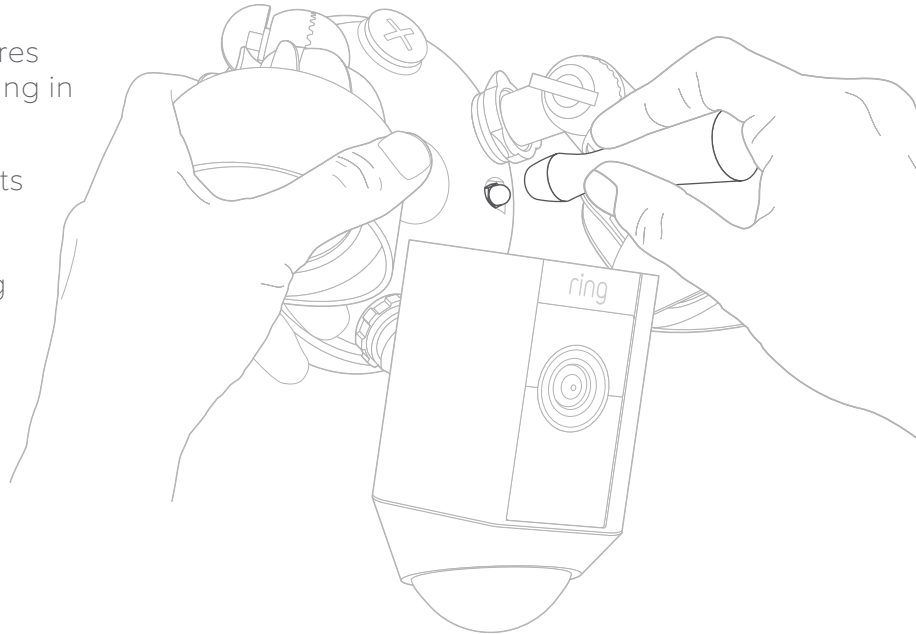

Restore power at the breaker

After restoring power, the lights will turn on and your Floodlight Cam will begin speaking to you to let you know it's in setup mode.



Perform the in-app setup

In the Ring app, select Set Up a Device and follow the in-app instructions to connect Floodlight Cam to your Wi-Fi network.

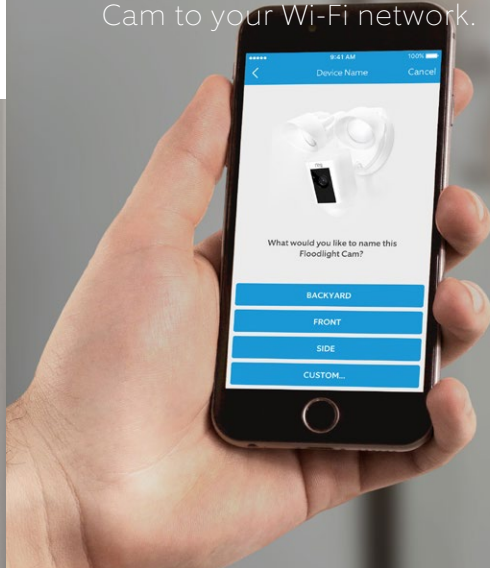

After setup, select your Floodlight Cam in the Ring app

This will bring you to the Device Dashboard, where you can change settings and access various features.

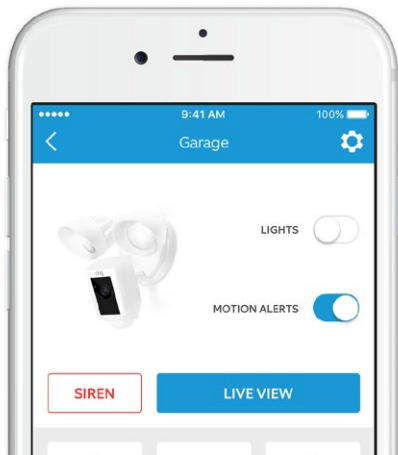

LIGHTS

Manually control the lights.

MOTION ALERTS

Toggle notifications for activity in any of the camera's motion zones.



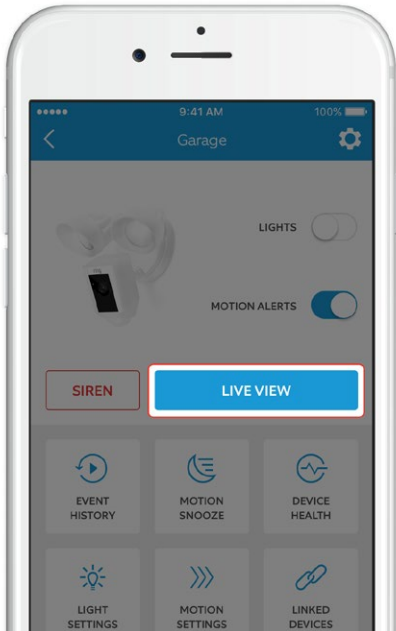

SIREN

Trigger the siren. It is loud and may be heard by your neighbors. Use it with care.

Select Live View to open a live video stream



During live video, you can access these features:

-  **Two-way Talk** – Speak to visitors and hear what they have to say.
-  **Siren** – Activate the siren.
-  **Lights** – Turn the lights on and off.
-  **Ring Neighborhoods** – Share suspicious events with your neighbors.



Select Motion Settings

to customize your motion preferences

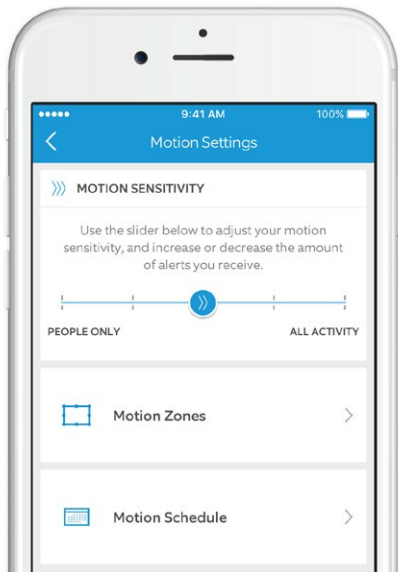

»»» MOTION SENSITIVITY

Allows you to adjust the amount of alerts you receive. Choose People Only to get motion alerts from humans only.



Motion Zones

Draw up to three custom areas where you'd like to receive motion alerts and trigger the lights.



Motion Schedule

Schedule times when you don't want to receive motion alerts.



To detect motion, you will need to set up Motion Zones, which is a customizable area you want your Ring to monitor and receive alerts.

To set up a Motion Zone, select Motion Settings. On this screen, create up to three Motion Zones. You will need at least one Motion Zone to be active to get alerts.

If your phone is locked when the camera captures a live event, you will receive a notification on your home screen.

If your phone has a passcode, you'll need to enter it to access the live event.

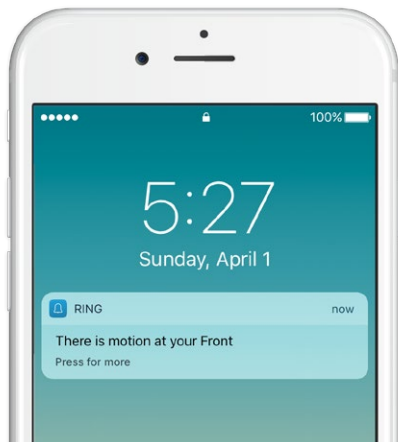



Select Light Settings

to set a schedule for your lights to stay on

Select Advanced Settings on the Light Settings screen to customize the areas that will trigger the lights and change how long they stay on for.

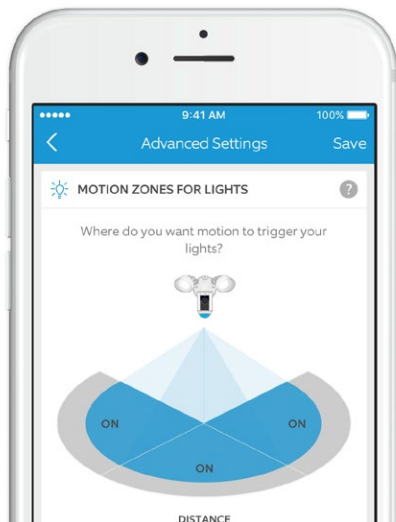
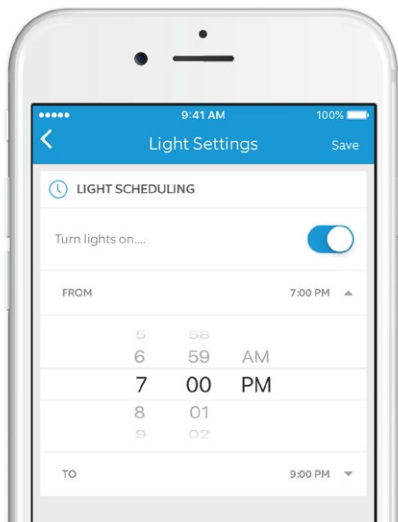

Troubleshooting Tips

My lights aren't turning on when Floodlight Cam detects motion.

The lights only turn on for motion when it's dark outside. If it is dark out and the lights still aren't turning on, adjust the motion settings for the lights by selecting Light Settings in the Ring app, and then selecting Advanced Settings.

I'm having issues with video/audio quality and/or load times.

Issues with video and/or audio are usually related to problems with Wi-Fi signal strength or Internet speed. For an optimal experience, we recommend Internet speeds of at least 1–2Mbps. Check your Internet speed by selecting Device Health in the Ring app, then selecting Test Your Wi-Fi.

If your Internet speed is sufficient, then look at Signal Strength in Device Health. If Signal Strength is not Good, you'll need to boost the Wi-Fi signal to your Floodlight Cam, which can be done with our product, Chime Pro.

Floodlight Cam is not lighting up when I restore power.

See if there is a light switch controlling power to your floodlight fixture. If so, make sure it is switched on and stays switched on. If your fixture is connected to a timer, you'll need to turn off the timer functionality.

Floodlight Cam lights up, but I can't complete the in-app setup.

First, double check your Wi-Fi password, since this is the most common reason Floodlight Cam can't complete setup.

Second, check the distance to your Wi-Fi router or access point. Installing Floodlight Cam too far from your access point may prevent setup from completing. In this case the installation of a Ring Chime Pro can help boost your Wi-Fi signal and provide audible alerts from your Floodlight Cam and other Ring products.

Learn more about Chime Pro by visiting: ring.com/chime-pro

For additional help, visit:
ring.com/help

Or give us a call...

US 1 800 656 1918

UK 01727 263045

AU 1 300 205 983

NZ +64 9 887 9871

Mexico (D.F) 52 55 8526 5445

Worldwide +1 310 929 7085

For a list of all our customer
support numbers, visit:
ring.com/callus

To review your warranty coverage, please visit www.ring.com/warranty.

Patents: www.ring.com/patents

© 2019 Ring LLC or its affiliates.

Ring, Always Home, and all related logos are trademarks of Amazon.com, Inc.
or its affiliates.

Last updated: 03/01/19